

Aspire 4720G/4720Z/4720/4320 Series Service Guide

Service guide files and updates are available on the ACER/CSD web; for more information, please refer to <http://csd.acer.com.tw>

PRINTED IN TAIWAN

Revision History

Please refer to the table below for the updates made on Aspire 4720G/4720Z/4720/4320 service guide.

Date	Chapter	Updates

Copyright

Copyright © 2007 by Acer Incorporated. All rights reserved. No part of this publication may be reproduced, transmitted, transcribed, stored in a retrieval system, or translated into any language or computer language, in any form or by any means, electronic, mechanical, magnetic, optical, chemical, manual or otherwise, without the prior written permission of Acer Incorporated.

Disclaimer

The information in this guide is subject to change without notice.

Acer Incorporated makes no representations or warranties, either expressed or implied, with respect to the contents hereof and specifically disclaims any warranties of merchantability or fitness for any particular purpose. Any Acer Incorporated software described in this manual is sold or licensed "as is". Should the programs prove defective following their purchase, the buyer (and not Acer Incorporated, its distributor, or its dealer) assumes the entire cost of all necessary servicing, repair, and any incidental or consequential damages resulting from any defect in the software.

Acer is a registered trademark of Acer Corporation.

Intel is a registered trademark of Intel Corporation.

Pentium and Pentium II/III are trademarks of Intel Corporation.

Other brand and product names are trademarks and/or registered trademarks of their respective holders.

Conventions

The following conventions are used in this manual:

SCREEN MESSAGES	Denotes actual messages that appear on screen.
NOTE	Gives bits and pieces of additional information related to the current topic.
WARNING	Alerts you to any damage that might result from doing or not doing specific actions.
CAUTION	Gives precautionary measures to avoid possible hardware or software problems.
IMPORTANT	Reminds you to do specific actions relevant to the accomplishment of procedures.

Preface

Before using this information and the product it supports, please read the following general information.

1. This Service Guide provides you with all technical information relating to the BASIC CONFIGURATION decided for Acer's "global" product offering. To better fit local market requirements and enhance product competitiveness, your regional office MAY have decided to extend the functionality of a machine (e.g. add-on card, modem, or extra memory capability). These LOCALIZED FEATURES will NOT be covered in this generic service guide. In such cases, please contact your regional offices or the responsible personnel/channel to provide you with further technical details.
2. Please note WHEN ORDERING FRU PARTS, that you should check the most up-to-date information available on your regional web or channel. If, for whatever reason, a part number change is made, it will not be noted in the printed Service Guide. For ACER-AUTHORIZED SERVICE PROVIDERS, your Acer office may have a DIFFERENT part number code to those given in the FRU list of this printed Service Guide. You MUST use the list provided by your regional Acer office to order FRU parts for repair and service of customer machines.

System Specifications

Features

Below is a brief summary of the computer's many features:

Operating system

- Genuine Windows® Vista™ Home Premium
- Genuine Windows® Vista™ Home Basic
- Genuine Windows® Vista™ Starter

NOTE: Windows® Vista™ Capable PCs come with Windows® XP installed, and can be upgraded to Windows® Vista™. For more information on Windows® Vista™ and how to upgrade, go to: Microsoft.com/windowsvista.

Platform and memory

- Intel® Centrino® Duo mobile processor technology, featuring:
 - Intel® Core™ 2 Duo mobile processor T7300/T7500/T7700 (4 MB L2 cache, 2/2.2/2.4 GHz, 800 MHz FSB),
 - Intel® Core™ 2 Duo mobile processor T7100 (2 MB L2 cache, 1.8 GHz, 800 MHz FSB)
 - Intel® Core™ 2 Duo mobile processor T5250/T5450 (2 MB L2 cache, 1.5/1.66 GHz, 667 MHz FSB)
 - Intel® 965PM/965GM Express chipset
- Intel® PRO/Wireless 3945ABG network connection (dual-band tri-mode 802.11a/b/g) Wi-Fi CERTIFIED® solution, supporting Acer SignalUp™ wireless technology or Intel® PRO/Wireless 3945BG network connection (dual-band 802.11b/g) Wi-Fi CERTIFIED® solution, supporting Acer SignalUp™ wireless technology
- Core logic: Intel® 965PM/965GM + ICH8M (north bridge + south bridge).
- Up to 2GB of DDR2 677 MHz memory, upgradeable to 4GB using two soDIMM modules (dual-channel support)

Display and graphics

- 14.1" WXGA TFT LCD, up to and including 1280 x 800 pixel resolution
- 200-nit brightness, 16 ms response time
- Simultaneous multi-window viewing via Acer Vista™ support
- Dual independent display
- 16.7 million colors
- Mobile Intel® GM965 Express chipset with integrated 3D graphics, featuring Intel® Graphic Media Accelerator (GMA) X3100 with up to 358 MB of Intel Dynamic Video Memory Technology 4.0 (8MB of dedicated GDDR2 VRAM, up to 350 MB of shared system memory), supporting Microsoft DirectX® 9 and DirectX® 10 (for selected models) or
- NVIDIA GeForce® 8400M SE with up to 1024 MB of TurboCache™ (128/256 MB of dedicated GDDR2 VRAM, 896/ 768 MB of share system memory), supporting NVIDIA® PureVideo™ technology (WMV HD, High Definition MPEG-2 hardware acceleration), Microsoft® DirectX® 9, DirectX® 10, OpenEXR High Dynamic Range (HDR) technology, and PCI Express® (for selected models)

-
- MPEG-2/DVD hardware-assisted capability (acceleration/full decode) (for selected models)
 - WMV9 (VC-1) and H.264 (AVC) support (acceleration/full decode) (for selected models)
 - S-video/TV-out (NTSC/PAL) support
 - Acer Arcade™ featuring Acer CinemaVision™ and Acer ClearVision™ technologies

Audio

- Dolby® certified surround sound system with two built-in stereo speakers
- Dolby® Home Theater audio enhancement featuring Dolby® Digital, Dolby® Digital Live, Dolby® PRO LOGIC II, Dolby® Digital Stereo Creator, Dolby® Headphone and Dolby® Virtual Speaker technologies
- Intel® High Definition audio support
- S/PDIF (Sony/Philips Digital Interface) support for digital speakers
- MS Sound compatible
- Built-in microphone

Storage subsystem

- One 80/120/160/240/250 GB or larger Serial ATA hard disk drives
- Optical drive options: DVD/CDRW Combo and DVD-Super Multi double-layer drive support
- 5-in-1 card reader, supporting Secure Digital (SD), MultiMediaCard (MMC), Memory Stick® (MS), Memory Stick PRO™ (MS PRO), and xD-Picture Card™ (xD)

Input devices

- 88-/89-/93-key keyboard, with inverted "T" cursor layout; 2.5 mm (minimum) key travel
- Seamless touchpad pointing device with 4-way scroll button
- 12 function keys, four cursor keys, two Windows® keys, hotkey controls, embedded numeric keypad, international language support, independent US and Euro dollar sign keys
- Empowering Key
- Easy-launch buttons: WLAN, Internet, email, Bluetooth, Acer Arcade™

Communication

- Acer Video Conference, featuring:
 - Integrated Acer Crystal Eye webcam, supporting Acer
 - PrimaLite™ technology
 - Optional Acer Xpress VoIP phone
- WLAN: Intel® PRO/Wireless 3945ABG network connection (dual-band tri-mode 802.11a/b/g) Wi-Fi CERTIFIED® solution, supporting Acer SignalUp™ wireless technology (for selected models) or Intel® PRO/Wireless 3945BG network connection (dual-mode 802.11b/g) Wi-Fi CERTIFIED® solution, supporting Acer SignalUp™ wireless technology (for selected models)
- WPAN: Bluetooth® 2.0+EDR (Enhanced Data Rate)
- LAN: Gigabit Ethernet supporting ASF (Alert Standard Format) 2.0; Wake-on-LAN ready
- Modem: 56K V.92 modem with PTT approval; Wake-on-Ring ready

I/O Ports

- Express Card slot
- 5-in-1 card reader (SD/MMC/MS/MS PRO/xD)
- Four USB 2.0 ports
- IEEE 1394 port

-
- Consumer infrared (CIR) port
 - External display (VGA) port
 - S-video/TV-out (NTSC/PAL) port
 - Headphones/speaker/line-out port with S/PDIF support
 - Microphone-in jack
 - Line-in jack
 - Ethernet (RJ-45) port
 - Modem (RJ-11) port
 - DC-in jack for AC adapter

Environment

- Temperature:
 - ✦ Operating: 5°C to 35°C
 - ✦ Non-operating: -20°C to 65°C
- Humidity (non-condensing):
 - ✦ Operating: 20%~80%
 - ✦ Non-operating: 20%~80%

System Block Diagram

NESTOS SYSTEM BLOCK DIAGRAM

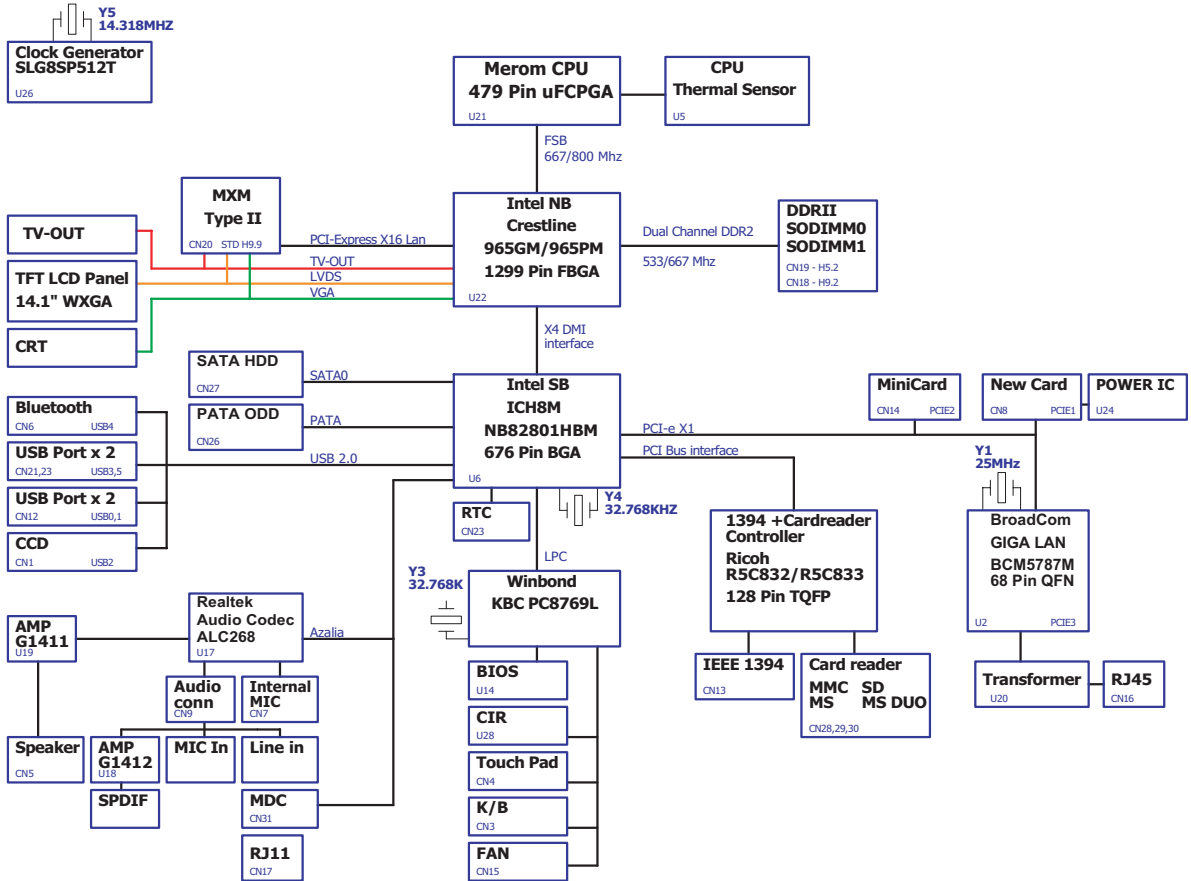

Board Layout

Top View

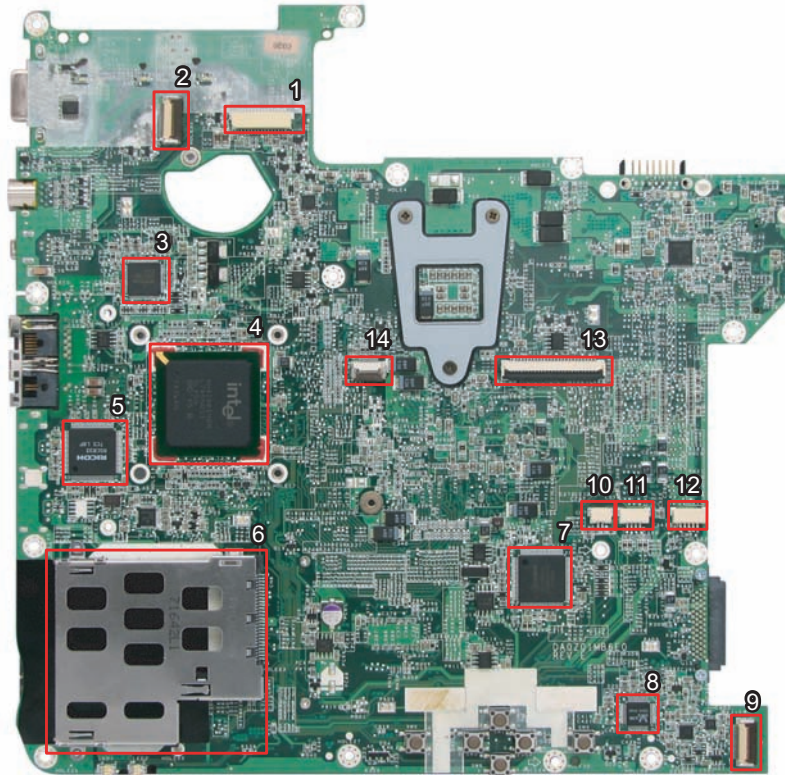

1	CN1	LVDS Connector	8	U17	Audio Codec (ALC 268)
2	CN2	Switch Board Connector	9	CN9	Audio Board Connector
3	U2	BCM5787	10	CN7	Microphone Connector
4	U6	South Bridge (ICH8M)	11	CN5	Speaker Connector
5	U8	PCI Card Reader Controller (RICOH R5C833)	12	CN6	Bluetooth Connector
6	CN8	Express Card Socket	13	CN3	Keyboard Connector
7	U13	Winbond Keyboard Controller (WPC9769LDG)	14	CN4	Touchpad Connector

Bottom View

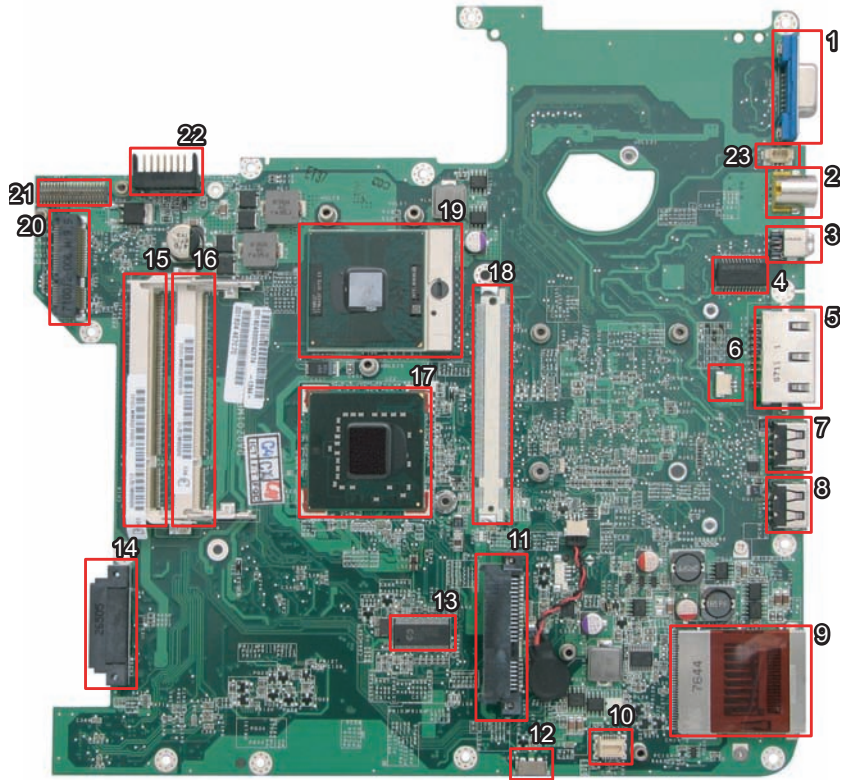

1	CN10	VGA Connector	13	U26	Clock Generator
2	CN11	S-Video Connector	14	CN26	Optical Disk Drive Connector
3	CN13	Ethernet Controller (BCM5787)	15	CN18	DIMM Socket
4	U20	LAN Transform	16	CN19	DIMM Socket
5	CN16	RJ45/RJ11 Jack	17	U22	North Bridge (965PM/GM)
6	CN17	Modem Cable Connector	18	CN20	MXM Connector (for selected models only)
7	CN21	USB Connector	19	U21	CPU Socket
8	CN22	USB Connector	20	CN14	Mini Card Socket
9	CN28	5-in-1 Card Reader	21	CN12	Power Board Connector
10	CN31	Modem Card Connector	22	PJ1	Battery Connector
11	CN27	SATA HDD Connector	23	CN15	Fan Connector
12	U28	Consumer Infrared Receiver			





Your Acer Notebook tour

After knowing your computer features, let us show you around your new Aspire computer.

Front View









#	Icon	Item	Description
1		Built-in camera	0.3 megapixel web camera for video communication.
2		Status indicators	Light-Emitting Diodes (LEDs) that light up to show the status of the computer's functions and components.
3		Speaker	Left and right speakers deliver stereo audio output.

4		Wireless communication button/indicator	Enables/disables the wireless function. Indicates the status of wireless LAN communication.
5		Keyboard	For entering data into your computer.
6		Touchpad	Touch-sensitive pointing device which functions like a computer mouse.
7		4-way scroll button	To scroll up, down, left, and right.
8		Click buttons (left and right)	The left and right buttons function like the left and right mouse buttons.
9		Microphone	Internal microphone for sound recording.
10		Display screen	Also called Liquid-Crystal Display (LCD), displays computer output.
11		WWW/E-mail/User-programmable buttons	Buttons to launch your internet browser, e-mail reader, or a specified application.
12		Power button	Turns the computer on and off.
13		Empowering button	Launches the Empowering Technology toolbar.
14		Bluetooth [®] communication button/indicator	Enables/disables the Bluetooth [®] function. Indicates the status of Bluetooth communication.
15		Palmrest	Comfortable support area for your hands when you use the computer.

Closed Front View









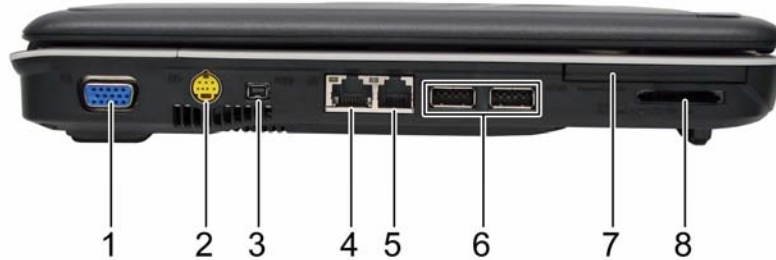

#	Icon	Item	Description
1		Power indicator	Indicates the computer's power status.
2		Battery indicator	Indicates the computer's battery status.
3		Infrared port	Interfaces with infrared devices (e.g., infrared printer and IR-aware computer).
4		Line-in jack	Accepts audio line-in devices (e.g., audio CD player, stereo walkman).
5		Microphone-in jack	Accepts input from external microphones.

6		Headphones/speaker/line-out jack with S/PDIF support	Connects to audio line-out devices (e.g., speakers, headphones).
7		Volume control	Increases and decreases the volume.



Left View



#	Icon	Item	Description
1		External display (VGA) port	Connects to a display device (e.g., external monitor, LCD projector).
2		S-video/TV-out (NTSC/PAL) port	Connects to a television or display device with S-video input.
3		4-pin IEEE 1394 port	Connects to IEEE 1394 devices.
4		Ethernet (RJ-45)	Connects to an Ethernet 10/100/1000-based network (for selected models).
5		Modem (RJ-11) port	Connects to a phone line.
6		2 USB 2.0 ports	Connect to USB 2.0 devices (e.g., USB mouse, USB camera).
7		Express Card slot	Accepts one Express Card, 54mm or 34mm types.
8		5-in-1 card reader	Accepts Secure Digital (SD), MultiMediaCard (MMC), Memory Stick (MS), Memory Stick PRO (MS PRO), xD-Picture Card (xD).

Right View



#	Icon	Item	Description
1		Optical drive	Internal optical drive; accepts CDs or DVDs (slot-load or tray-load depending on model).
2		Optical disk access indicator	Lights up when the optical drive is active.
3		Optical drive eject button	Ejects the optical disk from the drive.
4		Emergency eject hole	Ejects the optical drive tray when the computer is turned off.
5		2 USB 2.0 ports	Connect to USB 2.0 devices (e.g., USB mouse, USB camera).
6		DC-in jack	Connects to an AC adapter.
7		Kensington lock slot	Connects to a Kensington-compatible computer security lock.

Rear view



#	Icon	Item	Description
1		Ventilation slot	Enable the computer to stay cool, even after prolonged use.

Base view









#	Item	Description
1	Battery bay	Houses the computer's battery pack.
2	Battery lock	Locks the battery in position.
3	Battery release latch	Releases the battery for removal.
4	Ventilation slots and cooling fan	Enable the computer to stay cool, even after prolonged use. Note: Do not cover or obstruct the opening of the fan.
5	Back panel	Houses the computer's hard disk and main memory.

Indicators

The computer has several easy-to-read status indicators.



The front panel indicators are visible even when the computer cover is closed up.

Icon	Function	Description
	HDD	Indicates when the hard disc or optical drive is active.
	Num lock	Lights when Num Lock is activated.
	Cap lock	Lights when Cap Lock is activated
	Power	Lights up when the computer is on.
	Battery	Lights up when the battery is being charged.
	Bluetooth	Indicates the status of Bluetooth communication.
	Wireless LAN	Indicates the status of wireless LAN communication.

NOTE: 1. **Charging:** The light shows amber when the battery is charging. 2. **Fully charged:** The light shows green when in AC mode.

Easy-Launch Buttons

To the right of the keyboard there are three easy-launch buttons: Web browser, mail, and arcade buttons. You can also find an Empowering Key “*e*” located above the keyboard.

Press “*e*” to run the Acer Empowering Technology. The mail and Web browser buttons are pre-set to email and Internet programs, but can be reset by users. To set the programmable buttons (Web browser button, mail button, and Empowering key), run the Acer Launch Manager.



Launch key	Default application
e	Acer Empowering Technology (user-programmable)
Web browser	Internet browser (user-programmable)
Mail	Email application (user-programmable)
Arcade	Acer Arcade utility

Touchpad Basics

The following teaches you how to use the touchpad:

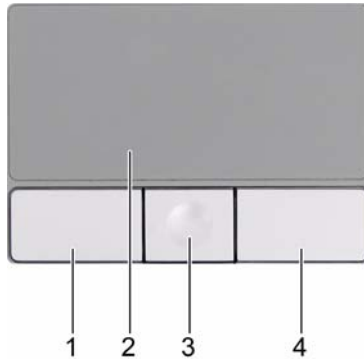

- Move your finger across the touchpad (2) to move the cursor.
- Press the left (1) and right (4) buttons located beneath the touchpad to perform selection and execution functions. These two buttons are similar to the left and right buttons on a mouse. Tapping on the touchpad is the same as clicking the left button.
- Use the 4-way scroll (3) button to mimic your cursor pressing on the right scroll bar of Windows applications.

Function	Left Button (1)	Main Touchpad (2)	4-Way Scroll Button (3)	Right Button (4)
Execute	Click twice quickly	Tap twice (at the same speed as double-clicking the mouse button)		
Select	Click once	Tap once		
Drag	Click and hold, then use finger on the touchpad to drag the cursor.	Tap twice (at the same speed as double-clicking a mouse button); rest your finger on the touchpad on the second tap and drag the cursor.		
Access context menu				Click once
Scroll			Click and hold to move up/down/left/right.	

NOTE: When using the touchpad, keep it - and your fingers - dry and clean. The touchpad is sensitive to finger movements; hence, the lighter the touch, the better the response. Tapping too hard will not increase the touchpad's responsiveness.

Using the Keyboard

The keyboard has full-sized keys and an embedded keypad, separate cursor keys, one Windows key and twelve function keys.

Lock Keys and embedded numeric keypad

The keyboard has three lock keys which you can toggle on and off.

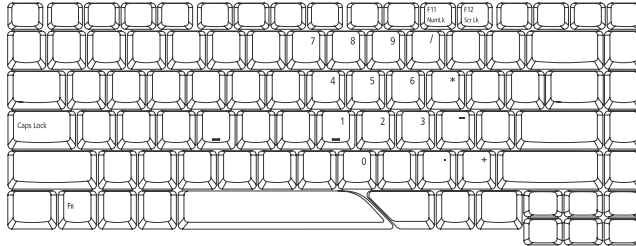



















Lock Key	Description
Caps Lock	When Caps Lock is on, all alphabetic characters typed are in uppercase.
Num Lock <Fn>+<F11>	When Num Lock is on, the embedded keypad is in numeric mode. The keys function as a calculator (complete with the arithmetic operators +, -, *, and /). Use this mode when you need to do a lot of numeric data entry. A better solution would be to connect an external keypad.
Scroll Lock <Fn>+<F12>	When Scroll Lock is on, the screen moves one line up or down when you press the up or down arrow keys respectively. Scroll Lock does not work with some applications.

The embedded numeric keypad functions like a desktop numeric keypad. It is indicated by small characters located on the upper right corner of the keycaps. To simplify the keyboard legend, cursor-control key symbols are not printed on the keys.

Desired Access	Num Lock On	Num Lock Off
Number keys on embedded keypad	Type numbers in a normal manner.	
Cursor-control keys on embedded keypad	Hold <Shift> while using cursor-control keys.	Hold <Fn> while using cursor-control keys.
Main keyboard keys	Hold <Fn> while typing letters on embedded keypad.	Type the letters in a normal manner.

Windows Keys

The keyboard has one key that performs Windows-specific functions.

Key	Icon	Description
Windows key 		<p>Pressed alone, this key has the same effect as clicking on the Windows Start button; it launches the Start menu. It can also be used with other keys to provide a variety of function:</p> <ul style="list-style-type: none">  + <D> Displays the desktop.  + <E> Opens the Windows Explorer.  + <F> Opens the Search: All Files dialog box.  + <G> Cycles through Sidebar gadgets.  + <L> Locks your computer (if you are connected to a network domain), or switch users (if you're not connected to a network domain)  + <F1> Opens Help and Support.  + <M> Minimizes all windows.  + <R> Opens the Run dialog box.  + <T> Cycles through programs on the taskbar.  + <U> Opens Ease of Access Center.  + <X> Opens Windows Mobility Center.  + <Break> Displays the System Properties dialog box  + <Shift> + <M> Restores the minimized windows to the desktop.  + <Tab> Activates next taskbar button.  + <Space Bar> Brings all gadgets to the front and select Windows Sidebar. <Ctrl> +  + <F> Searches for computers (if you are on a network) <Ctrl> +  + <Tab> Uses the arrow keys to cycle through programs on the taskbar by using Window Flip 3-D
Application key 		This key has the same effect as clicking the right mouse button; it opens the application's context menu.

Hot Keys

The computer employs hotkeys or key combinations to access most of the computer's controls like screen brightness, volume output, and the BIOS utility.

To activate hot keys, press and hold the **<Fn>** key before pressing the other key in the hotkey combination.

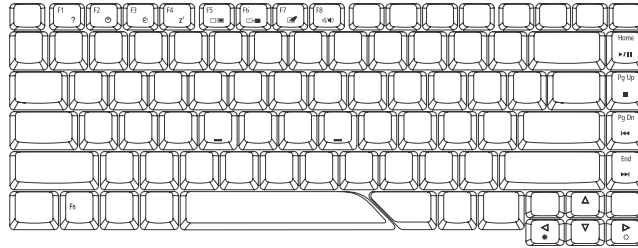

Hot Key	Icon	Function	Description
<Fn>+<F1>	?	Hot key help	Displays help on hot keys.
<Fn>+<F2>		Acer eSettings	Launches the Acer eSettings in Acer eManager.
<Fn>+<F3>		Acer ePower Management	Launches the Acer ePower Management in Acer Empowering Technology. See “Acer Empowering Technology” on page 18.
<Fn>+<F4>	Z ^z	Sleep	Puts the computer in Sleep mode.
<Fn>+<F5>		Display toggle	Switches display output between the display screen, external monitor (if connected) and both.
<Fn>+<F6>		Screen blank	Turns the display screen backlight off to save power. Press any key to return.
<Fn>+<F7>		Touchpad toggle	Turns the internal touchpad on and off.
<Fn>+<F8>		Speaker toggle	Turns the speakers on and off.
<Fn>+<F9>		Brightness up	Increases the screen brightness.
<Fn>+<F10>		Brightness down	Decreases the screen brightness
<Fn>+<Home>		Play/Pause	Plays or pauses the media.
<Fn>+<Pg Up>		Stop	Stops the media playing.

Hot Key	Icon	Function	Description
<Fn>+<Pg Dn>	⏮	Previous	Returns to previous media file.
<Fn>+<End>	⏭	Next	Jumps to next media file.

Special Key

You can locate the Euro symbol and US dollar sign at the upper-center and/or bottom-right of your keyboard.

To type:

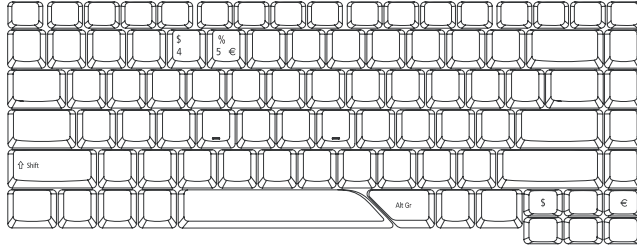

The Euro symbol

1. Open a text editor or word processor.
2. Either directly press the <€> symbol at the bottom-right of the keyboard, or hold <Alt Gr> and then press the<5> symbol at the upper-center of the keyboard.

NOTE: Some fonts and software do not support the Euro symbol. Please refer to www.microsoft.com/typography/faq/faq12.htm for more information.

The US dollar sign

1. Open a text editor or word processor.
2. Either directly press the <\$> key at the bottom-right of the keyboard, or hold <Shift> and then press the <4> key at the upper-center of the keyboard.

NOTE: This function varies by the operating system version.

Acer Empowering Technology

Acer's innovative Empowering Technology makes it easy for you to access frequently used functions and manage your new Acer notebook. It features the following handy utilities:

- ❑ **Acer eNet Management** hooks up to location-based networks intelligently.
- ❑ **Acer ePower Management** extends battery power via versatile usage profiles.
- ❑ **Acer eAudio Management** allows you to easily control the enhanced sound effects of Dolby® Home Theater™ on your system.
- ❑ **Acer ePresentation Management** connects to a projector and adjusts display settings conveniently.
- ❑ **Acer eDataSecurity Management** protects data with passwords and advanced encryption algorithms.
- ❑ **Acer eLock Management** limits access to external storage media.
- ❑ **Acer eRecovery Management** backs up and recovers data flexibly, reliably and completely.
- ❑ **Acer eSettings Management** accesses system information and adjusts settings easily.



For more information, press the < *e* > key to launch the Empowering Technology toolbar, then click on the appropriate utility and select the Help or Tutorial function.

Empowering Technology password

Before using Acer eLock Management and Acer eRecovery Management, you must initialize the Empowering Technology password. Right-click on the Empowering Technology toolbar and select "Password Setup" to do so. If you do not initialize the Empowering Technology password, you will be prompted to do so when running Acer eLock Management or Acer eRecovery Management for the first time.

Acer eNet Management

Acer eNet Management helps you to quickly and easily connect to both wired and wireless networks in a variety of locations. To access this utility, either click on the “**Acer eNet Management**” icon on your notebook, or start the program from the Start menu. You also have the option to set Acer eNet Management to start automatically when you boot up your PC.

Acer eNet Management automatically detects the best settings for a new location, while offering you the freedom to manually adjust the settings to match your needs.

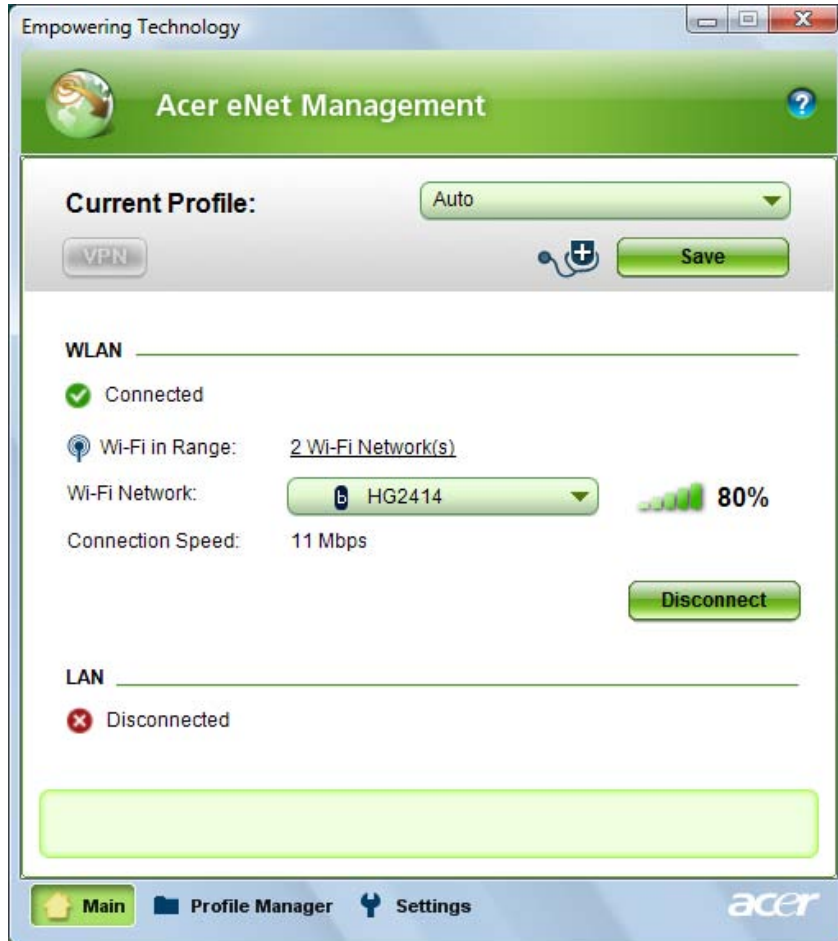

Acer eNet Management can save network settings for a location to a profile, and automatically switch to the appropriate profile when you move from one location to another. Settings stored include network connection settings (IP and DNS settings, wireless AP details, etc.), as well as default printer settings.

Security and safety concerns mean that Acer eNet Management does not store username and password information.



Acer ePower Management

Acer ePower Management features a straightforward user interface. To launch it, select Acer ePower Management from the Empowering Technology interface.

AC Mode (Adapter mode)

The default setting is “Maximum Performance.” You can adjust CPU speed, LCD brightness and other settings, or click on buttons to turn the following functions on/off: Wireless LAN, Bluetooth, CardBus, FireWire (1394), Wired LAN and Optical Device if supported.

DC Mode (Battery mode)

There are three pre-defined profiles - Balanced, Power Saver, and High Performance. You can also define the power plan optimized for your needs.

To create new power plan

1. Select a predefined power plan and click the  icon shown on the lower left-hand side.
2. Enter the name for the newly created power plan.
3. Select one of the predefined power plan that is closest to what you want.
4. Change the display and sleep settings as desired.
5. Click “OK” to apply the setting.
6. A new power plan is created.

Battery status

For real-time battery life estimates based on current usage, refer to the time shown in the “Remaining Battery Life” field.



For additional power options, click “**More Power option**”.

Acer eAudio Management

Acer eAudio Management allows you to easily control the enhanced sound effects of Dolby® Home Theater™ on your system. Select "Movie" or "Game" mode to experience the awesome realism of 5.1-channel surround sound from just 2 speakers, via Dolby Virtual Speaker technology. "Music" mode lets you enjoy your favorite tunes, in vivid detail.



((Surround On))



((Surround On))



Surround Off

Acer ePresentation Management

Acer ePresentation Management lets you project your computer's display to an external device or project using the hot key: Fn + F5. If auto-detection hardware is implemented in the system, your system display will be automatically switched out when an external display is connected to the system.

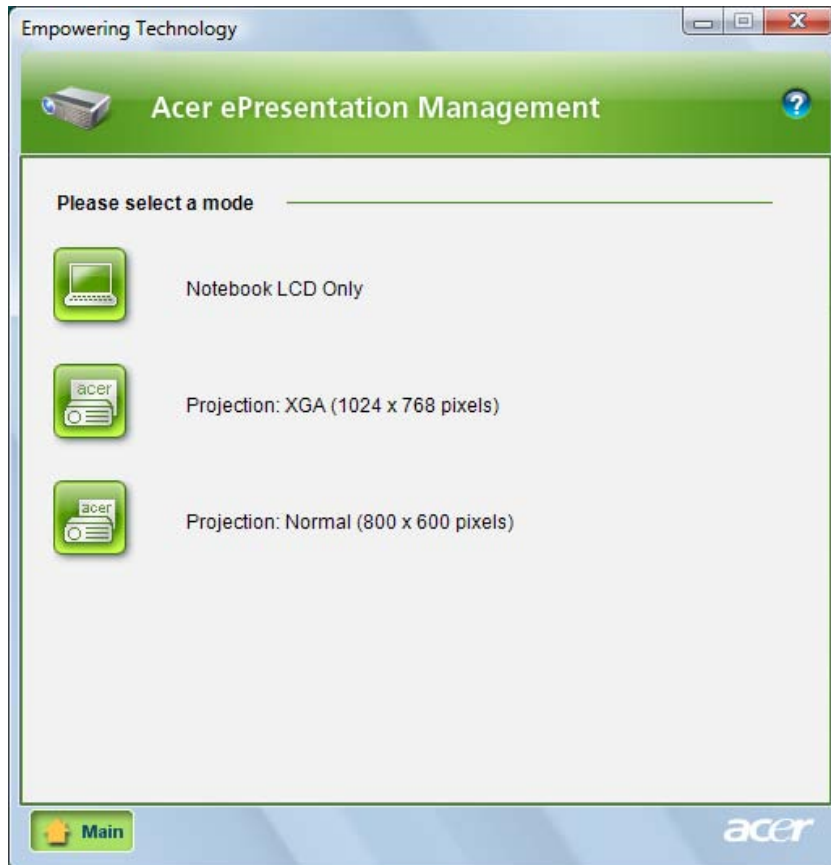

Acer eDataSecurity Management

Acer eDataSecurity Management is handy file encryption utility that protects your files from being accessed by unauthorized persons. It is conveniently integrated with Windows explorer as a shell extension for quick and easy data encryption/decryption and also supports on-the-fly file encryption for MSN Messenger and Microsoft Outlook.

The Acer eDataSecurity Management setup wizard will prompt you for a supervisor password and default encryption. This encryption will be used to encrypt files by default, or you can choose to enter your won file-specific password when encrypting a file.

NOTE: The password used encrypt a file is the unique key that the system needs to decrypt it. If you lose the password, the supervisor password is the only other key capable of decrypting the file. If you lose both passwords, there will be no way to decrypt your encrypted file! **Be sure to safeguard all related passwords!**

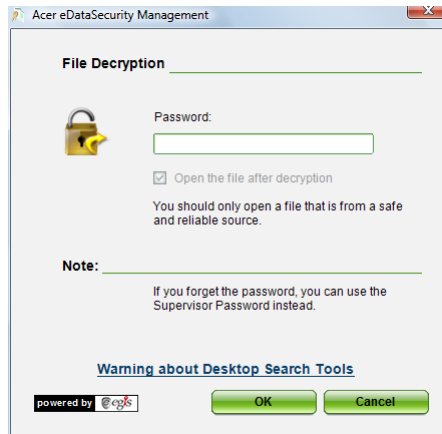
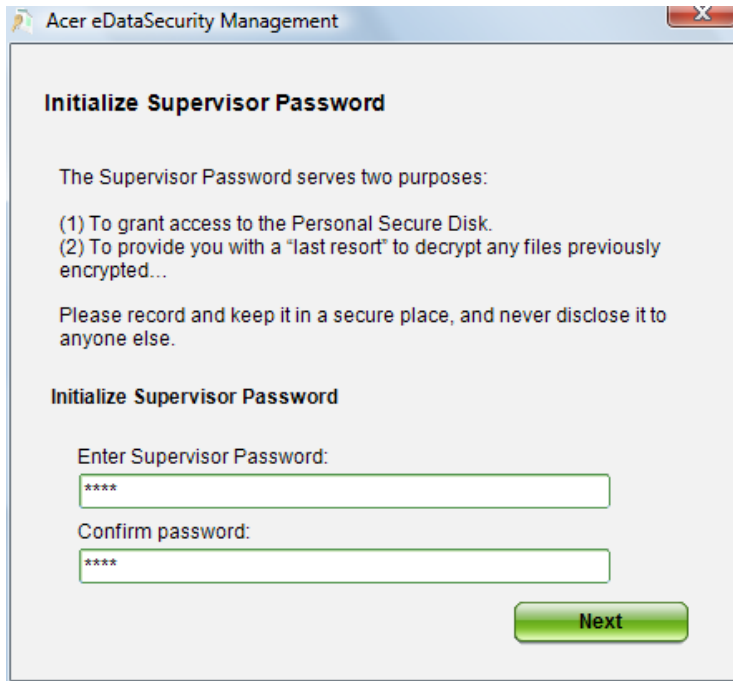

Acer eLock Management

Acer eLock Management is a security utility that allows you to lock your removable data, optical and floppy drives to ensure that data cannot be stolen while your notebook is unattended.

- Removable data devices - includes USB disk drives, USB pen drives, USB flash drives, USB MP3 drives, USB memory card readers, IEEE 1394 disk drives and any other removable disk drives that can be mounted as a file system when plugged into the system.
- Optical drive devices - includes any kind of CD-ROM or DVD-ROM drives.
- Floppy disk drives - 3.5-inch disks only.
- Interfaces - includes serial ports, parallel port, infrared (IR), and Bluetooth.

To activate Acer eLock Management, a password must be set first. Once set, you can apply locks to any of the devices. Lock(s) will immediately be set without any reboot necessary, and will remain locked after rebooting, until unlocked.

NOTE: If you lose your password, there is no method to reset it except by reformatting your notebook or taking your notebook to an Acer Customer Service Center. Be sure to remember or write down your password.

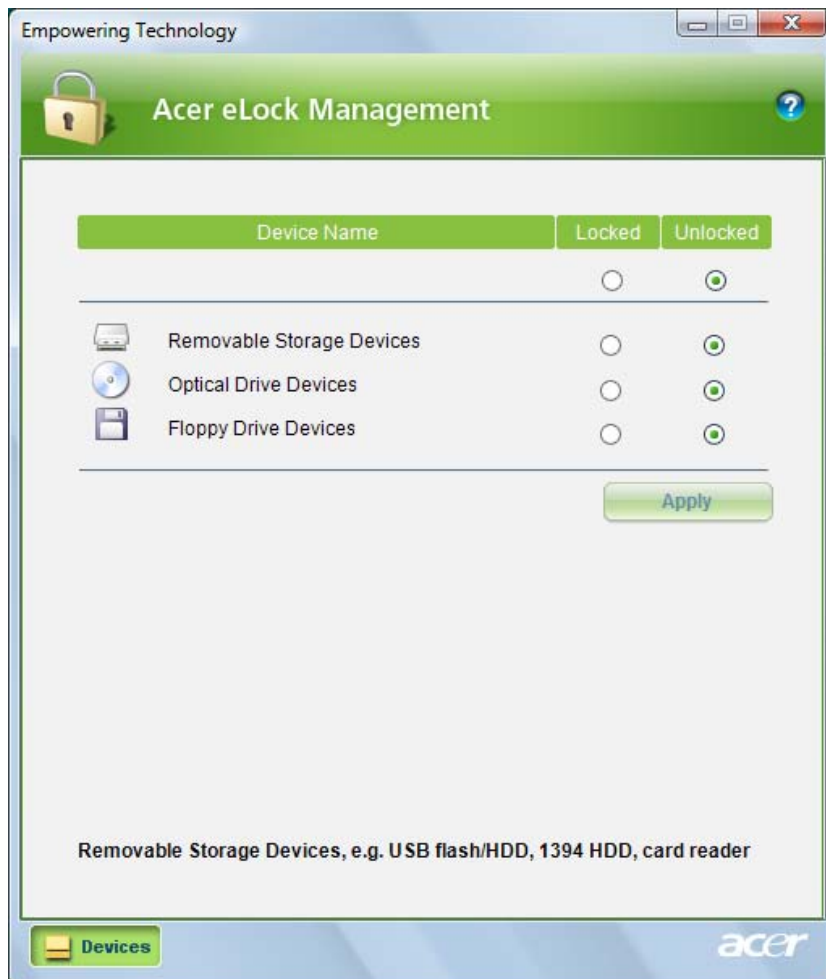

Acer eRecovery Management

Acer eRecovery Management is a powerful utility that does away with the need for recovery disks provided by the manufacturer. The Acer eRecovery Management utility occupies space in a hidden partition on your system's HDD. User-created backups are stored on D:\ drive. Acer eRecovery Management provides you with:

- Password protection.
- Recovery of applications and drivers.
- Image/data backup:
 - Back up to HDD (set recovery point).
 - Back up to CD/DVD.
- Image/data recovery tools:
 - Recover from a hidden partition (factory defaults).
 - Recover from the HDD (most recent user-defined recovery point).
 - Recover from CD/DVD.



For more information, please refer to “Acer eRecovery Management”

NOTE: If your computer did not come with a Recovery CD or System CD, please use Acer eRecovery Management’s “System backup to optical disk” feature to burn a backup image to CD or DVD. To ensure the best results when recovering your system using a CD or Acer eRecovery Management, detach all peripherals (except the external Acer ODD, if your computer has one), including your Acer ezDock.

Acer eSettings Management

Acer eSettings Management allows you to inspect hardware specifications and to monitor the system health status. Furthermore, Acer eSettings Management enables you to optimize your Windows operating system, so your computer runs faster, smoother and better.

Acer eSettings Management also:

- Provides a simple graphical user interface for navigating.
- Displays general system status and advanced monitoring for power users.

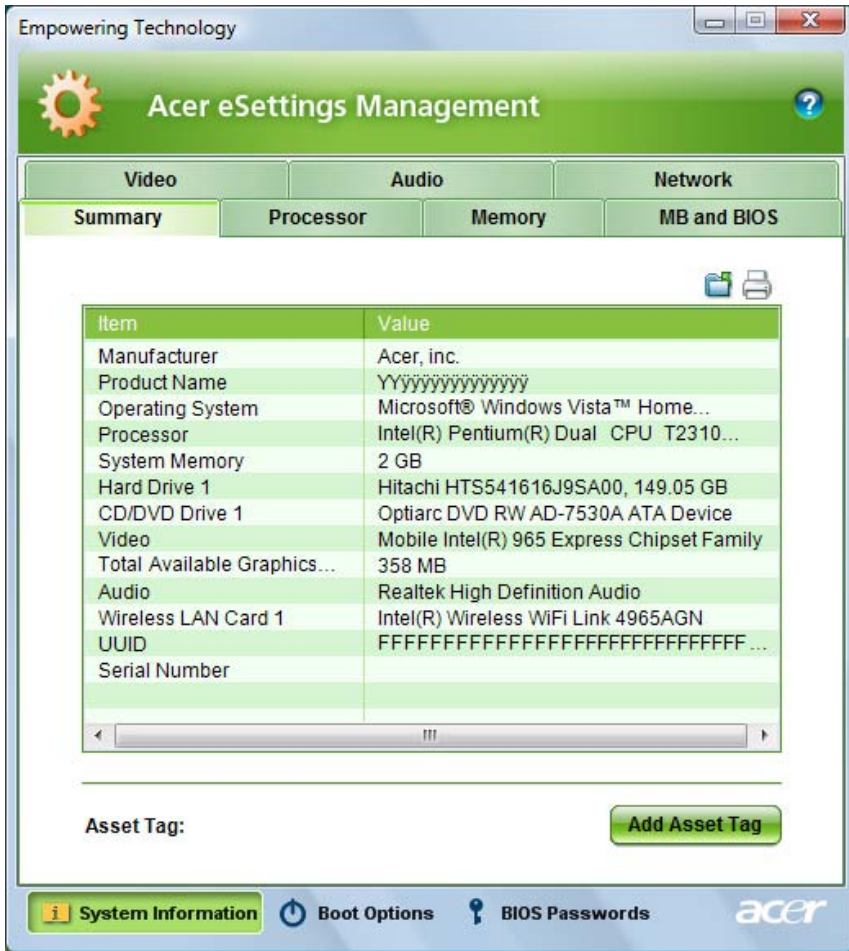

Getting to know your Acer Crystal Eye webcam

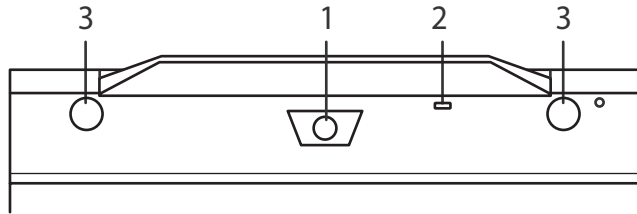

No.	Item
1	Lens
2	Power indicator
3	Rubber grip (selected models only)

Launching the Acer Crystal Eye webcam

To launch the Acer Crystal Eye webcam, double click on the Acer Crystal Eye webcam icon on the screen.

OR

Click Start > All programs > Crystal Eye webcam > Acer Crystal Eye webcam. The Acer Crystal Eye webcam capture window appears.



Changing the Acer Crystal Eye webcam resolution

To change the capture resolution, click the displayed resolution button to select the desired resolution.

Using the Acer Crystal Eye webcam

The Acer Crystal Eye webcam is automatically selected as the capture device of any instant messenger (IM) application. To use the Acer Crystal Eye webcam in the IM application, open the IM service, then select the video/webcam feature. You can now broadcast from your location to an IM partner anywhere in the world.

Using the System Utilities

NOTE: The system utilities work under Microsoft Windows XP only.

Acer GridVista (dual-display compatible)

NOTE: This feature is only available on certain models.

To enable the dual monitor feature of the notebook, first ensure that the second monitor is connected, then open the **Display Settings** properties box using the **Control Panel** or by right-clicking the Windows desktop and selecting **Personalize**. Select the secondary monitor (**2**) icon in the display box and then click the check box **Extend the desktop onto this monitor**. Finally, click **Apply** to confirm the new settings and click **OK** to complete the process.

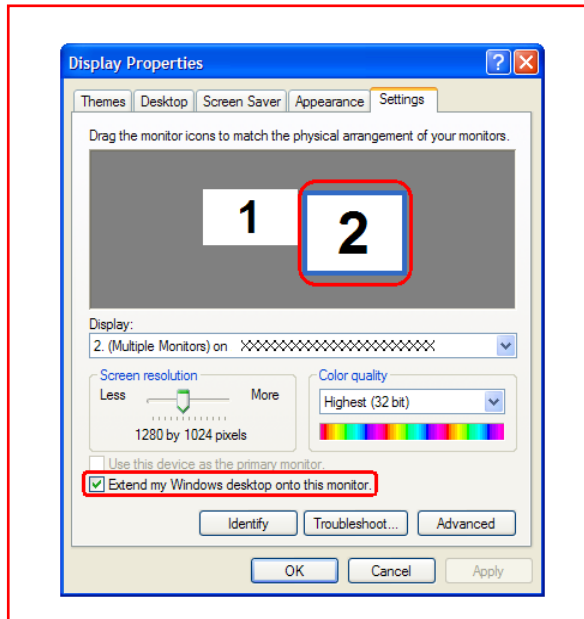

Acer GridVista is a handy utility that offers four pre-defined display settings so you can view multiple windows on the same screen. To access this function, please go to **Start > All Programs** and click on **Acer GridVista**. You may choose any one of the four display settings indicated below:



Double (vertical), Triple (primary at left), Triple (primary at right), or Quad Acer Gridvista is dual-display compatible, allowing two displays to be partitioned independently.

Acer Gridvista is dual-display compatible, allowing two displays to be partitioned independently.

AcerGridVista is simple to set up:

1. Run Acer GridVista and select your preferred screen configuration for each display from the task bar.
2. Drag and drop each window into the appropriate grid.
3. Enjoy the convenience of a well-organized desktop.

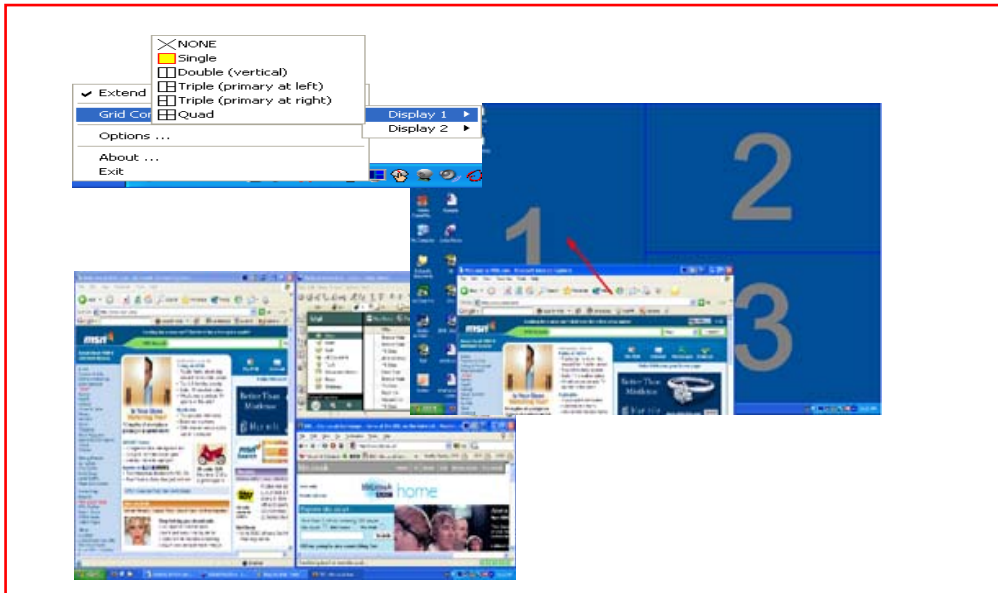

NOTE: Please ensure that the resolution setting of the second monitor is set to the manufacturer's recommended value.

Launch Manager



Launch Manager allows you to set the four easy-launch buttons (see their locations mentioned in "Easy-Launch Buttons"). You can access the Launch Manager by clicking **Start > All Programs > Launch Manager > Launch Manager** to start the application.

Hardware Specifications and Configurations

Processor

Item	Specification
CPU type	Intel® Core™2 Duo mobile processor T7300/T7500/T7700 (4MB, L2 cache 2.0/2.2/2.4 GHz, 800 MHz FSB) Intel® Core™2 Duo processor T7100 (2MB, L2 cache 1.8 GHz, 667 MHz FSB) Intel® Core™2 Duo processor T5250/T5450 (2MB, L2 cache 1.5/1.66 GHz, 667 MHz FSB)
Core logic	Intel® 965PM/965GM Express chipset + ICH8M
CPU package	Intel 478-pin Micro FCBGA socket
CPU core voltage	0.9~1.1125V

CPU Fan True Value Table

TEST Condition: 35W@Ambient 35 degree C			
CPU Temperature		Fan Speed	Acoustic Level
Core 0	Core 1	(rpm)	(dBA)
86	86	3700	39
88	88	3450	36.5
91	91	3150	34.5
95	95	2800	31

BIOS

Item	Specification
BIOS vendor	Phoenix
BIOS Version	
BIOS ROM type	Flash ROM
BIOS ROM size	1MB
BIOS package	8 pin SOP
Supported protocols	ACPI 2.0/3.0, PCI 2.2, System/HDD Password Security Control, INT 15 Extensions, PnP BIOS 1.0a, SMBIOS 2.3, Simple Boot Flag 1.0, Boot Block, PCI Bus Power Management Interface Specification, USB 1.1/2.0, IEEE 1394 1.0, USB/1394 CD-ROM Boot Up support, PC Card 95 (PCMCIA 3.0 Compliant Device), Acer WMI, Acer LED, Acer VRAM, Acer MDA 2007 requirements, WfM 2.0, PXE (Preboot Execution Environment), BIS 1.0 (Boot Integrity Service Application Program Interface),
BIOS password control	Set by setup manual

NOTE: If you need to check PXE version, press F2 to enter BIOS then enable boot from LAN function. After that, power off the system and remove the HDD. Last, reboot the laptop. Then you will see PXE version displaying on the screen.

Second Level Cache

Item	Specification
Cache controller	
Cache size	256MB / 512MB / 1GB
1st level cache control	Always enabled
2st level cache control	Always enabled
Cache scheme control	Fixed in write-back

System Memory

Item	Specification
Memory controller	Built-in Intel® PM965
Memory size	0MB (no on-board memory)
DIMM socket number	2 sockets
Supports memory size per socket	2GB
Supports maximum memory size	4GB (by two 1024MB SO-DIMM module)
Supports DIMM type	DDR 2 Synchronous DRAM
Supports DIMM Speed	533/667 MHz
Supports DIMM voltage	1.8V
Supports DIMM package	JEDEC 200-pin soDIMM
Memory module combinations	You can install memory modules in any combinations as long as they match the above specifications.

Memory Combinations

Slot 1	Slot 2	Total Memory
0MB	128MB	128MB
0MB	256MB	256MB
0MB	512MB	512MB
0MB	1024MB	1024MB
0MB	2048MB	2048MB
128MB	128MB	256MB
128MB	256MB	384MB
128MB	512MB	640MB
128MB	1024MB	1152MB
128MB	2048MB	2176MB
256MB	128MB	384MB
256MB	256MB	512MB
256MB	512MB	768MB
256MB	1024MB	1280MB
256MB	2048MB	2304MB
512MB	128MB	640MB
512MB	256MB	768MB
512MB	512MB	1024MB
512MB	1024MB	1536MB
512MB	2048MB	2560MB
1024MB	0MB	1024MB
1024MB	128MB	1152MB
1024MB	256MB	1280MB
1024MB	512MB	1536MB
1024MB	1024MB	2048MB
1024MB	2048MB	3072MB
2048MB	2048MB	4096MB

NOTE: Above table lists some system memory configurations. You may combine DIMMs with various capacities to form other combinations. On above table, the configuration of slot 1 and slot 2 could be reversed.

System VRAM and VBIOS Options

System Memory	VBIOS Option in BIOS/CMOS	eSetting		OS		
		VRAM size	System memory size	VRAM size	System memory size	
512Mb	128MB	Dedicated	128MB	512MB	192MB	512MB
		Max. available	192MB			
	256MB	Dedicated	256MB	512MB	320MB	512MB
		Max. available	320MB			
	512MB	Dedicated	512MB	512MB	578MB	512MB
		Max. available	576MB			
1024MB	128MB	Dedicated	128MB	1024MB	383MB	1024MB
		Max. available	383MB			
	256MB	Dedicated	256MB	1024MB	511MB	1024MB
		Max. available	511MB			
	512MB	Dedicated	512MB	1024MB	767MB	1024MB
		Max. available	767MB			
2048MB	128MB	Dedicated	128MB	2048MB	895MB	2048MB
		Max. available	895MB			
	256MB	Dedicated	256MB	2048MB	1023MB	2048MB
		Max. available	1023MB			
	512MB	Dedicated	512MB	2048MB	1279MB	2048MB
		Max. available	1279MB			
4096MB	128MB	Dedicated	128MB	4096MB	1919MB	4096MB
		Max. available	1919MB			
	256MB	Dedicated	256MB	4096MB	2047MB	4096MB
		Max. available	2047MB			
	512MB	Dedicated	512MB	4096MB	2303MB	4096MB
		Max. available	2303MB			

LAN Interface

Item	Specification
Chipset	BroadCom BCM5787M
Supports LAN protocol	10/100/1000 Ethernet Giga LAN
LAN connector type	RJ45
LAN connector location	Left side
Features	S5 Wake on LAN support compliant with ACPI 2.0 PCI-E interface LAN controller LDCM support

Modem Interface

Item	Specification
Data modem data baud rate (bps)	56K
Supports modem protocol	V.90/V.92
Modem connector type	RJ11
Modem connector location	Right side

Bluetooth Interface

Item	Specification
Chipset	FOXCONN T60H928.01 Bluetooth miniUSB module
Data throughput	723 bps (full speed data rate)
Protocol	Bluetooth 2.0+EDR
Interface	USB 1.1
Connector type	USB

Wireless Module 802.11b/g, 802.11a/b/g, 802.11a/g/n

Item	Specification
Chipset	Intel
Data throughput	11~54 Mbps
Protocol	802.11b/g, 802.11a/b/g, or 802.11 a/g/n
Interface	Mini PCI or Wi-Fi

Hard Disk Drive Interface

Item			
Vendor & Model Name	Seagate 40G ST9402112A Toshiba MK4025GAS Hitachi HTS421240H9AT00 WD WD400UE-22HCT0 Samsung M40MP0402H	Seagate ST96812A Seagate ST960821A Toshiba MK6025GAS HGST HTS541260H9AT00 WD WD600UE-22HCT0	TOSHIBA MK8025GAS HITACHI HTS421280H9AT00 SEAGATE ST9808210A SEAGATE ST98823A TOSHIBA MK8026GAX HGST HTS541280H9AT00 WD WD800UE-22HCT0
Capacity (MB)	40000	60000	80000
Bytes per sector	512	512	512
Data heads	2	3 (for Hitachi and Seagate) 4 (for Toshiba)	4 (for Hitachi) 3 (for Seagate)
Drive Format			
Disks	1	2	2
Spindle speed (RPM)	4200 RPM	4200 RPM	4200 RPM
Performance Specifications			
Buffer size	2048KB	8192KB	8192KB
Interface	ATA/ATAPI-6; ATA-6	ATA/ATAPI-6; ATA-6	ATA/ATA-6; ATA-6
Max. media transfer rate (disk-buffer, Mbytes/s)	372	350	350
Data transfer rate (host~buffer, Mbytes/s)	100 MB/Sec. Ultra DMA mode-5	100 MB/Sec. Ultra DMA mode-5	100 MB/Sec. Ultra DMA mode-5
DC Power Requirements			
Voltage tolerance	5V(DC) +/- 5%	5V(DC) +/- 5%	5V(DC) +/- 5%

DVD-Dual Interface

Item	Specification	
Vendor & model name	LITEON SOSW-833S PIONEER DVR-K16RA	
Performance Specification	With CD Diskette	With DVD Diskette
Transfer rate (KB/sec)	Sustained: Max 3.6Mbytes/sec	Sustained: Max 10.8Mbytes/sec
Buffer Memory	2MB	
Interface	Enhanced IDE(ATAPI) compatible	
Applicable disc format	Support disc formats 1. Reads data in each CD-ROM, CD-ROM XA, CD-1, Video CD, CD-Extra and CD-Text 2. Reads data in Photo CD (single and Multi-session) 3. Reads standard CD-DA 4. Reads and writes CD-R discs 5. Reads and writes CD-RW discs 6. Reads and writes in each DVD+R/RW (Ver. 1.1) 7. Reads data in each DVD-ROM and DVD-R (Ver. 2.0 for Authoring) 8. Reads and writes in each DVD-R (Ver. 2.0 for general), DVD-RW and DVD+R/RW (Ver1.1)	
Loading mechanism	Load: Manual Release: (a) Electrical Release (Release Button) (b) Release by ATAPI command (c) Emergency Release	
Power Requirement		
Input Voltage	5 V +/- 5 % (Operating)	

Audio Interface

Item	Specification
Audio Controller	Realtek ALC268
Audio onboard or optional	Onboard
Mono or Stereo	Stereo
Resolution	18 bit stereo full duplex
Compatibility	HD audio Interface; S/PDIF output for PCM or AC-3 content
Sampling rate	44.1k/48k/96k/192kHz sample rate
Internal microphone	Yes
Internal speaker / Quantity	Yes/2 (1.5W speakers)
Supports PnP DMA channel	DMA channel 0 DMA channel 1
Supports PnP IRQ	IRQ10, IRQ11

USB Port

Item	Specification
Chipset	Integrated with ICH8M chipset
USB Compliancy Level	2.0
OHCI	USB 1.1 and USB 2.0 Host controller
Number of USB ports	4
Location	Two on the left side; two on the right side
Serial port function control	Enable/Disable by BIOS Setup

Express Card Slot

Item	Specification
PCI controller	RICOH R5C833
Supports card type	54mm and 34mm Express card
Number of slots	One Express card
Access location	Left side
Supports ZV (Zoomed Video) port	No ZV support
Supports 32 bit CardBus	Yes

System Board Major Chips

Item	Controller
Core logic	Intel ICH8M
LAN	Broadcom BCM5787M
USB 2.0	Integrated with ICH8M chipset
Super I/O controller	N/A
MODEM	Foxconn T60M951.00
Bluetooth	Foxconn T60H928.01
Wireless 802.11 b/g, a/b/g, a/g/n	Foxconn, Intel
PCI controller	RICOH R5C833
Audio	Realtek ALC268

Keyboard

Item	Specification
Keyboard controller	Winbond WPC8769L
Total number of keypads	88-/89-/93-key
Windows logo key	Yes
Internal & external keyboard work simultaneously	Plug USB keyboard to the USB port directly: Yes

Battery

Item	Specification
Vendor & model name	BATTERY PACK SANYO LI-ION 6 CELL 2.0, 4000MAH BATTERY PACK SONY LI-ION 6 CELL 2.0, 4000MAH BATTERY PACK PANASONIC LI-ION 6 CELL 2.0, 4000MAH BATTERY PACK SIMPLO LI-ION 6 CELL 2.0, 4000MAH BATTERY PACK SANYO LI-ION 6 CELL 2.0, 4800MAH BATTERY PACK SONY LI-ION 6 CELL 2.0, 4800MAH BATTERY PACK SIMPLO LI-ION 6 CELL 2.0, 4800MAH
Battery Type	Li-ion
Pack capacity	4000/4800MAH
Number of battery cell	6



Battery

Item	Specification
Package configuration	3S2P
Normal voltage	11.1V
Charge voltage	16.8+0.2v

LCD 14.1" inch

Item	Specification			
Vendor & model name	AUO B141EW04-V4 LF GLARE	LPL LP141WX1-TLA1 GLARE	AUO B141EW04-V3 LF NONE-GLARE	SAMSUNG WXGA LTN141W3-L01-0 GLARE
Screen Diagonal (mm)	14.1 inches	14.1 inches	14.1 inches	14.1 inches
Active Area (mm)	303.4x189.6	303.4x189.6	303.4x189.6	303.4x189.6
Display resolution (pixels)	1280 x 800 WXGA	1280 x 800 WXGA	1280 x 800 WXGA	1280 x 800 WXGA
Pixel Pitch	0.297x0.297	0.297x0.297	0.297x0.297	0.297x0.297
Pixel Arrangement	R.G.B. Vertical Stripe	R.G.B. Vertical Stripe	R.G.B. Vertical Stripe	R.G.B. Vertical Stripe
Display Mode	Normally White	Normally White	Normally White	Normally White
Typical White Luminance (cd/m ²) also called Brightness	200	200	200	200
Luminance Uniformity	N/A	N/A	70	70
Contrast Ratio	300	300	250	250
Response Time (Optical Rise Time/Fall Time)msec	16	16	16	16
Nominal Input Voltage VDD	+3.3V Typ.	+3.3V	3.3V	3.3V
Typical Power Consumption (watt)	5.6/5.7	3.96	N/A	N/A
Weight				
Physical Size (mm)				
Electrical Interface	1 channel LVDS	1 channel LVDS	1 channel LVDS	1 channel LVDS
Support Color	262K colors	262K colors	262K colors	262K colors
Viewing Angle (degree) Horizontal: Right/Left Vertical: Upper/Lower	45/45 20/45	45/45 20/45	45/45 20/45	45/45 20/45
Temperature Range (°C) Operating Storage (shipping)	0 to +50 -25 to +60	0 to +50 -25 to +60	0 to +50 -25 to +60	0 to +50 -25 to +60

LCD Inverter

Item	Specification
Vendor & model name	Darfon/V189-301GP
Brightness conditions	N/A
Input voltage (V)	9~21
Input current (mA)	2.56 (max)
Output voltage (V, rms)	780V (2000V for kick off)
Output current (mA, rms)	6.5 (max)
Output voltage frequency (k Hz)	65K Hz (max)

AC Adapter

Item	Specification
Input rating	Inlet 3p, 19V/3.42A, 65W, w LED, w/o PFC, universal Inlet 3p, 19V/4.74A, 90W, w LED, w PFC, universal
Maximum input AC current	3.42A / 4.74A
Inrush current	220A@115VAC 220A@230VAC
Efficiency	82% min. @115VAC input full load

System Power Management

ACPI mode	Power Management
Mech. Off (G3)	All devices in the system are turned off completely.
Soft Off (G2/S5)	OS initiated shutdown. All devices in the system are turned off completely.
Working (G0/S0)	Individual devices such as the CPU and hard disc may be power managed in this state.
Suspend to RAM (S3)	CPU set power down VGA Suspend PCMCIA Suspend Audio Power Down Hard Disk Power Down CD-ROM Power Down Super I/O Low Power mode
Save to Disk (S4)	Also called Hibernation Mode. System saves all system states and data onto the disc prior to power off the whole system.

System Utilities

BIOS Setup Utility

The BIOS Setup Utility is a hardware configuration program built into your computer's BIOS (Basic Input/Output System).

Your computer is already properly configured and optimized, and you do not need to run this utility. However, if you encounter configuration problems, you may need to run Setup. Please also refer to Chapter 4 Troubleshooting when problem arises.

To activate the BIOS Utility, press **F2** during POST (when "Press <F2> to enter Setup" message is prompted on the bottom of screen).

Press **F2** to enter setup. The default parameter of F12 Boot Menu is set to "disabled". If you want to change boot device without entering BIOS Setup Utility, please set the parameter to "enabled".











Press <F12> during POST to enter multi-boot menu. In this menu, user can change boot device without entering BIOS SETUP Utility.

Phoenix TrustedCore(tm) Setup Utility				
Information	Main	Security	Boot	Exit
CPU Type : Intel (R) Pentium(R) Dual CPU T2310 @ 1.46GHz CPU Speed : 1460 MHz IDE1 Model Name : Hitachi HTS541616J9SA00 IDE1 Serial Number : xxxxxxxxxxxxxxxxxxxxxxxx ATAPI Model Name : Optiarc DVD RW AD-7530A System BIOS Version: v1.3701 VGA BIOS Version: SantaRosa 1436 Serial Number: xxxxxxxxxxxxxxxxxxxxxxxx Asset Tag Number: Produce Name: Manufacturer Name: Acer UUID: xxxxxxxxxxxxxxxxxxxxxxxxxxxxxxxx				
F1 Help	↑↓ Select Item	F5/F6 Change Values	F9 Setup Defaults	
Esc Exit	←→ Select Menu	Enter Select	▶ Sub-Menu	F10 Save and Exit

Navigating the BIOS Utility

There are seven menu options: Info., Main, System Devices, Security, Power, Boot, and Exit.

Follow these instructions:

- ❑ To choose a menu, use the cursor left/right keys ( ).
- ❑ To choose an option, use the cursor up/down keys ( .
- ❑ To change an option format, press  or .
- ❑ A plus sign (+) indicates the item has sub-items. Press  to expand this item.
- ❑ Press  while you are in any of the menu options to go to the Exit menu.
- ❑ In any menu, you can load default settings by pressing . You can also press  to save any changes made and exit the BIOS Setup Utility.

NOTE: You can change the value of a parameter if it is enclosed in square brackets. Navigation keys for a particular menu are shown on the bottom of the screen. Help for parameters are found in the Item Specific Help part of the screen. Read this carefully when making changes to parameter values. **Please note that system information is subject to different models.**

Information

Phoenix TrustedCore(tm) Setup Utility

Information
Main
Security
Boot
Exit

```

CPU Type :           Intel (R) Pentium(R) Dual CPU T2310 @ 1.46GHz
CPU Speed :         1460 MHz

IDE1 Model Name :   Hitachi HTS541616J9SA00
IDE1 Serial Number : xxxxxxxxxxxxxxxxxxxxxxxx
ATAPI Model Name :  Optiarc DVD RW AD-7530A
System BIOS Version: v1.3701
VGA BIOS Version:   SantaRosa 1436
Serial Number:      xxxxxxxxxxxxxxxxxxxxxxxx
Asset Tag Number:
Produce Name:
Manufacturer Name:  Acer
UUID:              xxxxxxxxxxxxxxxxxxxxxxxxxxxxxxxx
          
```

F1 Help
↑↓ Select Item
F5/F6 Change Values
F9 Setup Defaults

Esc Exit
←→ Select Menu
Enter Select ▶ Sub-Menu
F10 Save and Exit

NOTE: The system information is subject to different models.

Parameter	Description
CPU Type / CPU Speed	This field shows the CPU type and speed of the system.
IDE1 Model Name	This field shows the model name of HDD installed on primary IDE master.
IDE1 Serial Number	This field displays the serial number of HDD installed on primary IDE master.
ATAPI Model Name	This field displays the model number of the installed ATAPI drive.
System BIOS Version	Displays system BIOS version.
VGA BIOS Version	This field displays the VGA firmware version of the system.
Serial Number	This field displays the serial number of this unit.
Asset Tag Number	This field displays the asset tag number of the system.
Product Name	This field shows product name of the system.
Manufacturer Name	This field displays the manufacturer of this system.
UUID Number	This will be visible only when an internal LAN device is presenting. UUID=32bytes

Main

The Main screen displays a summary of your computer hardware information, and also includes basic setup parameters. It allows the user to specify standard IBM PC AT system parameters.

Phoenix TrustedCore(tm) Setup Utility				
Information	Main	Security	Boot	Exit
System Time: [19:03:49] System Date : [08/25/2007] System Memory : 640 KB Shows system base memory size Extended Memory : 2038 MB Shows extended memory size Video Memory : [8MB] Quiet Boot : [Enabled] Power On Display : [Auto] Network Boot : [Enabled] F12 Boot Menu : [Disabled] D2D Recovery : [Enabled]				Item Specific Help <Tab>, <Shift-Tab>, or <Enter> selects field.
F1 Help	↑↓ Select Item	F5/F6 Change Values	F9 Setup Defaults	
Esc Exit	←→ Select Menu	Enter Select ▶ Sub-Menu	F10 Save and Exit	

NOTE: The screen above is for your reference only. Actual values may differ.

The table below describes the parameters in this screen. Settings in **boldface** are the default and suggested parameter settings.

Parameter	Description	Format/Option
System Time	Sets the system time. The hours are displayed with 24-hour format.	Format: HH:MM:SS (hour:minute:second) System Time
System Date	Sets the system date.	Format MM/DD/YYYY (month/day/year) System Date
System Memory	This field reports the memory size of the system. Memory size is fixed to 640MB	
Extended Memory	This field reports the memory size of the extended memory in the system. Extended Memory size=Total memory size-1MB	
Video Memory	Shows the Video memory size.	
Quiet Boot	Determines if Customer Logo will be displayed or not; shows Summary Screen is disabled or enabled. Enabled: Customer Logo is displayed, and Summary Screen is disabled. Disabled: Customer Logo is not displayed, and Summary Screen is enabled.	Option: Enabled or Disabled
Power On display	Auto: During power process, the system will detect if any display device is connected on external video port. If any external display device is connected, the power on display will be in CRT (or projector) only mode. Otherwise it will be in LCD only mode. Both: Simultaneously enable both the integrated LCD screen and the system's external video port (for an external CRT or projector).	Option: Auto or Both
Network Boot	Enables, disables the system boot from LAN (remote server).	Option: Enabled or Disabled
F12 Boot Menu	Enables, disables Boot Menu during POST. NOTE: The Boot device change is only for one time change. In other words, the next time system reboot, the boot device sequence will be the same as the one defined in the BIOS setup (Boot menu).	Option: Disabled or Enabled
D2D Recovery	Enables, disables D2D Recovery function. The function allows the user to create a hidden partition on hard disc drive to store operation system and restore the system to factory defaults.	Option: Enabled or Disabled

NOTE: The sub-items under each device will not be shown if the device control is set to disable or auto. This is because the user is not allowed to control the settings in these cases.

Security

The Security screen contains parameters that help safeguard and protect your computer from unauthorized use.

Phoenix TrustedCore(tm) Setup Utility				
Information	Main	Security	Boot	Exit
Supervisor Password Is : Clear User Password Is : Clear Hard Disk Password Status : Clear Set Supervisor Password [Enter] Set User Password [Enter] Set Hard Disk Password [Enter] Password on boot : [Disabled]				Item Specific Help Supervisor Password controls access to the setup utility.
F1 Help	↑↓ Select Item	F5/F6 Change Values	F9 Setup Defaults	
Esc Exit	←→ Select Menu	Enter Select ► Sub-Menu	F10 Save and Exit	

The table below describes the parameters in this screen. Settings in **boldface** are the default and suggested parameter settings.

Parameter	Description	Option
Supervisor Password Is	Shows the setting of the Supervisor password	Clear or Set
User Password Is	Shows the setting of the user password.	Clear or Set
Hard Disk Password Status	Shows the setting of the hard disk password.	Clear or HDD Password Set
Set Supervisor Password	Press Enter to set the supervisor password. When set, this password protects the BIOS Setup Utility from unauthorized access. The user can not either enter the Setup menu nor change the value of parameters.	
Set User Password	Press Enter to set the user password. When user password is set, this password protects the BIOS Setup Utility from unauthorized access. The user can enter Setup menu only and does not have right to change the value of parameters. NOTE: Only when the supervisor password was set then user password can be set.	
Set Hard Disk Password	Press Enter to set the hard disk password. When set, this password protects the internal hard disk from unauthorized access. The user can not either enter the Setup menu nor change the value of parameters.	
Password on boot	Defines whether a password is required or not while the events defined in this group happened. The following sub-options are all requires the Supervisor password for changes and should be grayed out if the user password was used to enter setup.	Disabled or Enabled

NOTE: When you are prompted to enter a password, you have three tries before the system halts. Don't forget your password. If you forget your password, you may have to return your notebook computer to your dealer to reset it.

Setting a Password

Follow these steps as you set the supervisor, user, or hard disk password:

- Use the **↑** and **↓** keys to highlight the Set Supervisor Password parameter and press the **ENTER** key. The Set Supervisor Password box appears:

Set Supervisor Password

Enter New Password []

Confirm New Password []

- Type a password in the "Enter New Password" field. The password length can not exceed 8 alphanumeric characters (A-Z, a-z, 0-9, not case sensitive). Retype the password in the "Confirm New Password" field.

IMPORTANT: Be very careful when typing your password because the characters do not appear on the screen.

- Press **ENTER**. After setting the password, the computer sets the Supervisor Password parameter to "Set".
- If desired, you can opt to enable the Password on boot parameter.

5. When you are done, press **F10** to save the changes and exit the BIOS Setup Utility.

Removing a Password

Follow these steps:

1. Use the **↑** and **↓** keys to highlight the Set Supervisor Password parameter and press the **ENTER** key. The Set Supervisor Password box appears:

Set Supervisor Password		
Enter Current Password	[]
Enter New Password	[]
Confirm New Password	[]

2. Type the current password in the Enter Current Password field and press **ENTER**.
3. Press **ENTER** twice **without** typing anything in the Enter New Password and Confirm New Password fields. The computer then sets the Supervisor Password parameter to "Clear".
4. When you have changed the settings, press **F10** to save the changes and exit the BIOS Setup Utility.

Changing a Password

1. Use the **↑** and **↓** keys to highlight the Set Supervisor Password parameter and press the **ENTER** key. The Set Supervisor Password box appears:

Set Supervisor Password		
Enter Current Password	[]
Enter New Password	[]
Confirm New Password	[]

2. Type the current password in the Enter Current Password field and press **ENTER**.
3. Type a password in the Enter New Password field. Retype the password in the Confirm New Password field.
4. Press **ENTER**. After setting the password, the computer sets the Supervisor Password parameter to "Set".
5. If desired, you can enable the Password on boot parameter.
6. When you are done, press **F10** to save the changes and exit the BIOS Setup Utility.

If the verification is OK, the screen will display as following.

Setup Notice		
Changes have been saved.		
[Continue]		

The password setting is complete after the user presses **F10**.

If the current password entered does not match the actual current password, the screen will show you the Setup Warning.

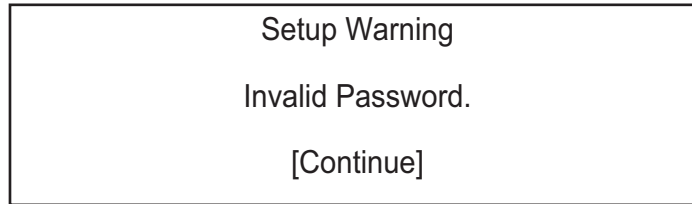

If the new password and confirm new password strings do not match, the screen will display the following message.

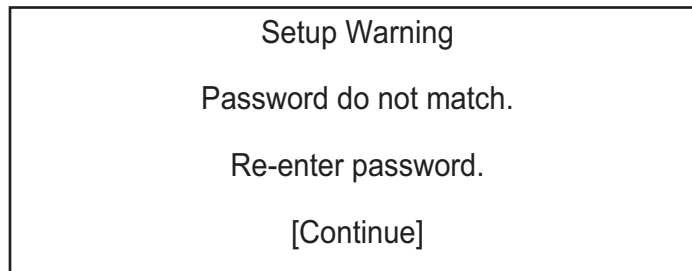

Boot

This menu allows the user to decide the order of boot devices to load the operating system. Bootable devices includes the onboard hard disk drive, the CD-ROM in module bay, and any external USB device.

Phoenix TrustedCore(tm) Setup Utility				
Information	Main	Security	Boot	Exit
Boot priority order: 1: IDE HDD: Hitachi HTS541616J9SA00-(S) 2: IDE CD : Optiarc DVD RW AD-7530A-(P) 3: PCI BEV : MBA v9.4.5 Slot 0500 4: USB HDD : 5: USB CDROM : 6: USB FDC : 7: USB KEY : 8: Excluded from boot order :			Item Specific Help	
			Keys used to view or configure devices : Up and Down arrows select a device. <+> and <-> moves the device up or down. <f> and <r> specifies the device fixed or removable. <x> exclude or include the device to boot. <Shift + 1> enables or disables a device. <1 - 4> Loads default boot sequence.	
F1 Help	↑↓	Select Item	F5/F6 Change Values	F9 Setup Defaults
Esc Exit	←→	Select Menu	Enter Select ► Sub-Menu	F10 Save and Exit

Exit

The Exit screen contains parameters that help safeguard and protect your computer from unauthorized use.

The table below describes the parameters in this screen.

Parameter	Description
Exit Saving Changes	Exit System Setup and save your changes to CMOS.
Exit Discarding Changes	Exit utility without saving setup data to CMOS.
Load Setup Defaults	Load default values for all SETUP item.
Discard Changes	Load previous values from CMOS for all SETUP items.
Save Changes	Save Setup Data to CMOS.

BIOS Flash Utility

The BIOS flash memory update is required for the following conditions:

- New versions of system programs
- New features or options
- Restore a BIOS when it becomes corrupted.

Use the Phlash utility to update the system BIOS flash ROM.

NOTE: If you do not have a crisis recovery diskette at hand, then you should create a **Crisis Recovery Diskette** before you use the Phlash utility.

NOTE: Do not install memory-related drivers (XMS, EMS, DPMS) when you use the Phlash.

NOTE: Please use the AC adapter power supply when you run the Phlash utility. If the battery pack does not contain enough power to finish BIOS flash, you may not boot the system because the BIOS is not completely loaded.

Follow the steps below to run the Phlash.

1. Prepare a bootable diskette.
2. Copy the flash utilities to the bootable diskette.
3. Then boot the system from the bootable diskette. The flash utility has auto-execution function.

Machine Disassembly and Replacement

This chapter contains step-by-step procedures on how to disassemble the notebook computer for maintenance and troubleshooting.

To disassemble the computer, you need the following tools:

- Wrist grounding strap and conductive mat for preventing electrostatic discharge
- Small Philips screw driver
- Philips screwdriver
- Plastic flat head screw driver
- Tweezers

NOTE: The screws for the different components vary in size. During the disassembly process, group the screws with the corresponding components to avoid mismatch when putting back the components. When you remove the stripe cover, please be careful not to scrape the cover.

General Information

Before You Begin

Before proceeding with the disassembly procedure, make sure that you do the following:

1. Turn off the power to the system and all peripherals.
2. Unplug the AC adapter and all power and signal cables from the system.
3. Remove the battery pack.

Disassembly Procedure Flowchart



The flowchart on the succeeding page gives you a graphic representation on the entire disassembly sequence and instructs you on the components that need to be removed during servicing. For example, if you want to remove the system board, you must first remove the keyboard, then disassemble the inside assembly frame in that order.

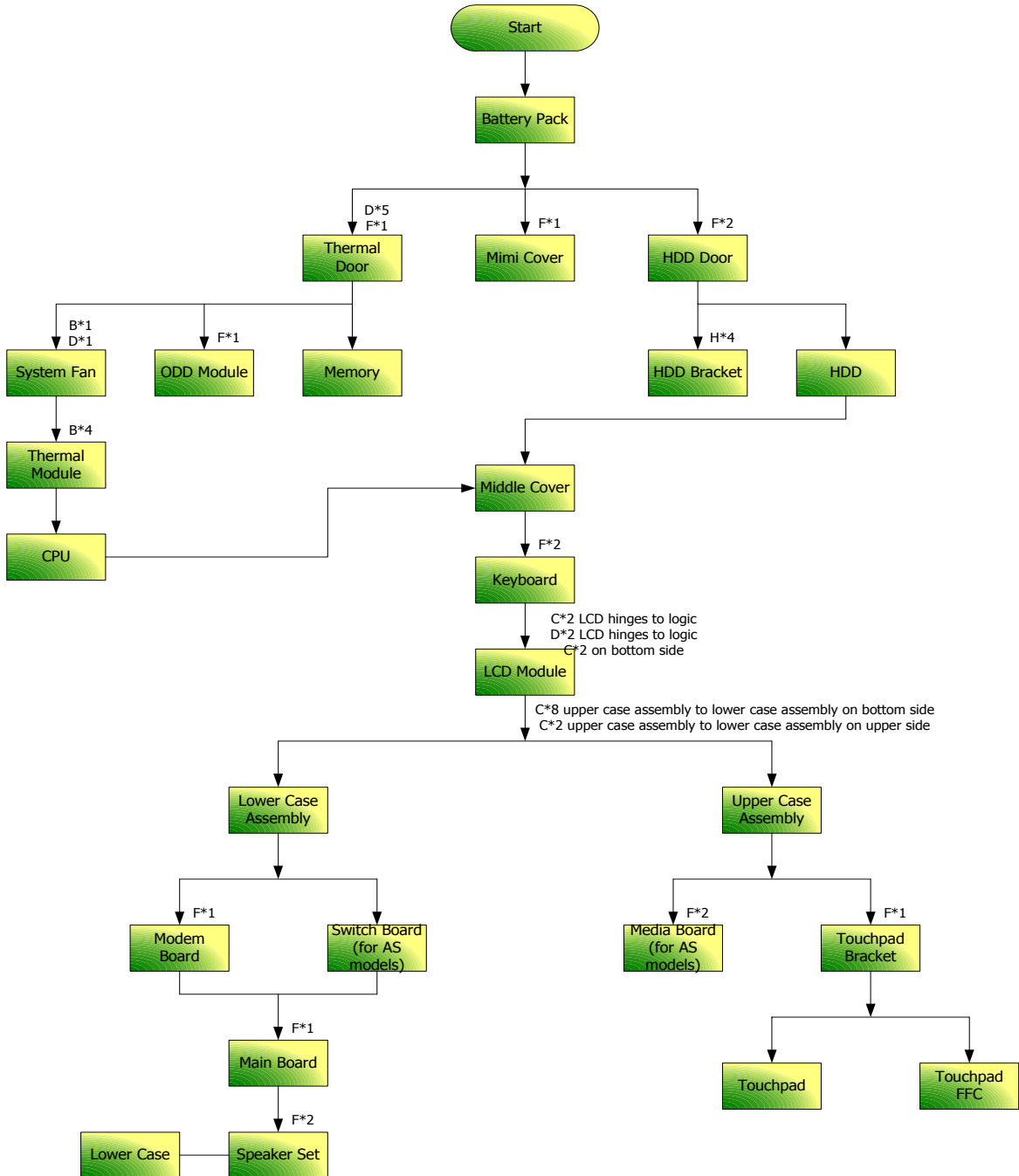

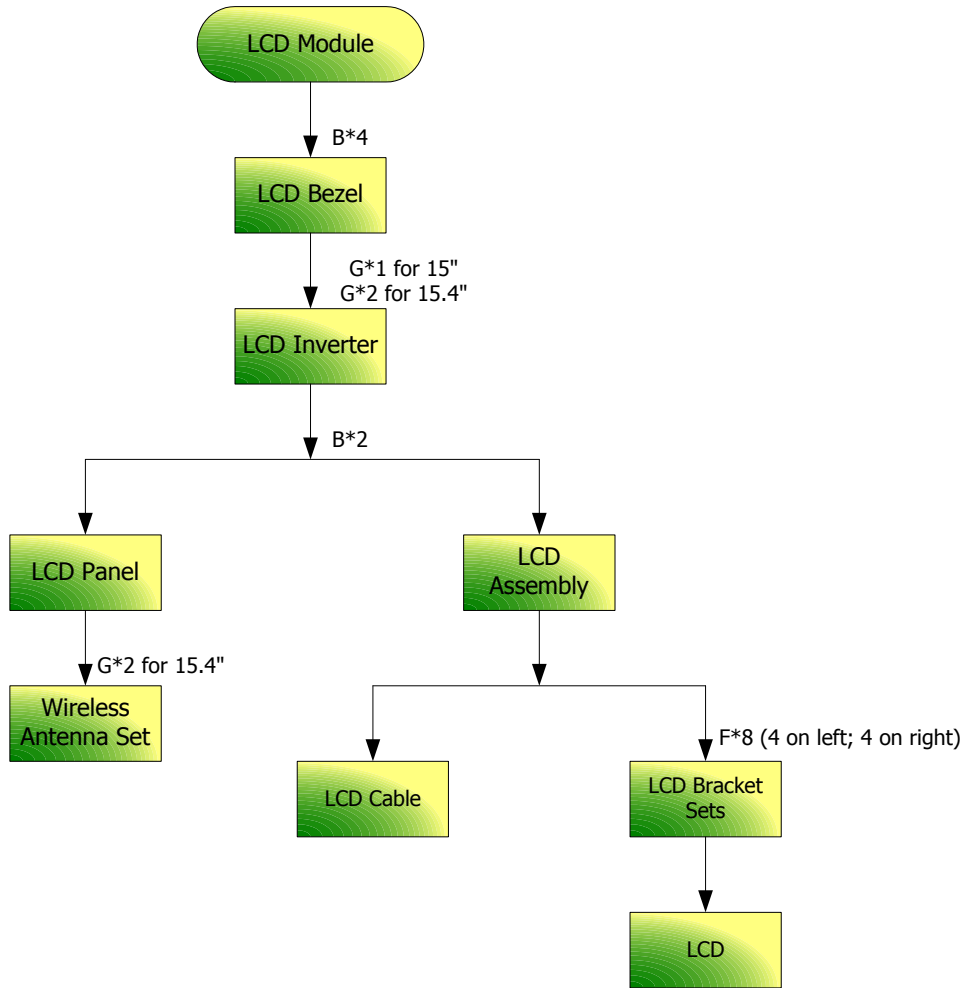

Screw List

Item	Description	Part Number
A	SCREW M2.0*3.0-I-NI-NYLOK	86.A08V7.005
B	SCREW M2.5*4.0-I(NI)(NYLOK)	86.D01V7.001
C	SCREW M2.5*3.5-I(BNI)(NYLOK)	86.AHS07.001
D	SCREW M1.6*3-I(NI)(NYLOK)	86.AHS07.002
E	SCREW M2.5 *7L-BNI-NYLOK	86.A10V7.006

Removing the Battery Pack

1. Unlock the battery lock as shown.
2. Slide the battery release latch then remove the battery.



Removing the HDD Module/ODD Module/Memory/Wireless LAN Card/Keyboard and the LCD Module

1. Press and release the PC dummy card from the PC slot as shown.



2. To access the internal laptop components, you have to first remove the back panel. Turn over the laptop and remove the seven screws fastening the back panel.
3. Lift the back panel up as shown.



Removing the HDD Module

4. Remove the two screws fastening the HDD module bracket.
5. Pull the tab on the HDD bracket to remove the HDD module in the direction of the arrow.

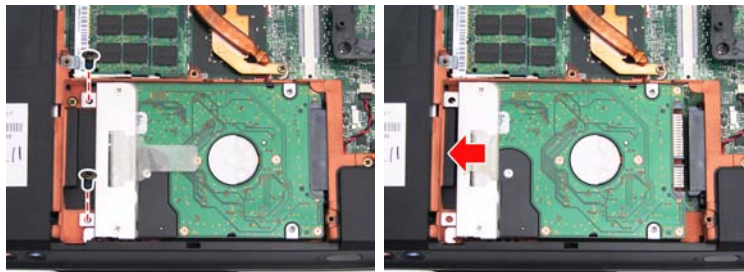

Removing the ODD Module

6. Remove the screw fastening the ODD module.
7. Use a flat screwdriver to gently push out the ODD module as shown.



Removing the Memory

8. Pull out the snaps securing the memory in place. The memory will pop up.
9. Remove the memory from the DIMM socket (If the notebook has two memory modules, then repeat this step).

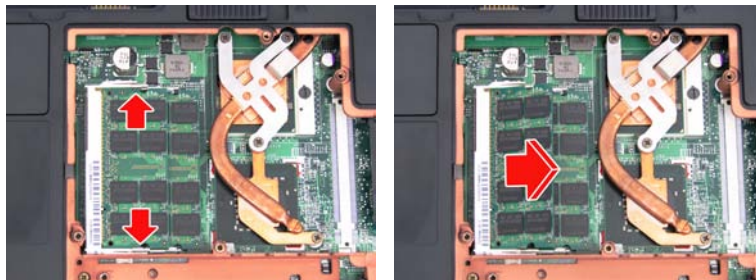

Removing the Wireless LAN Card

10. Remove the two screws fastening the wireless LAN card panel.
11. Lift up the panel as shown.
12. Disconnect the three antennae from the wireless LAN card.



13. Remove the two screws fastening the wireless LAN card.

14. Take out the wireless LAN card from the main unit.



Removing the Keyboard and LCD Module

1. Remove the eight screws fastening the keyboard and LCD module to the main unit.
2. Turn the notebook over and gently pry up and remove the switch board cover as shown.



3. Lift the keyboard up and towards you.
4. Disconnect the keyboard cable from the main board and remove the keyboard from the main unit.



-
5. Disconnect both ends of the switch board FFC cable.
 6. Disconnect the LCD and microphone cables, and pull through the wireless LAN antennae from the underside of the main unit.
 7. Remove the six screws securing the hinges.



8. Detach the LCD module from the main unit.



Disassembling the Main Unit

Separate the Main Unit Into the Upper and the Lower Case Assembly

1. Remove the ten screws fastening the lower case assembly to the upper case assembly.
2. Turn the notebook over and remove the three screws fastening the switch board.
3. Remove the switch board from the main unit.

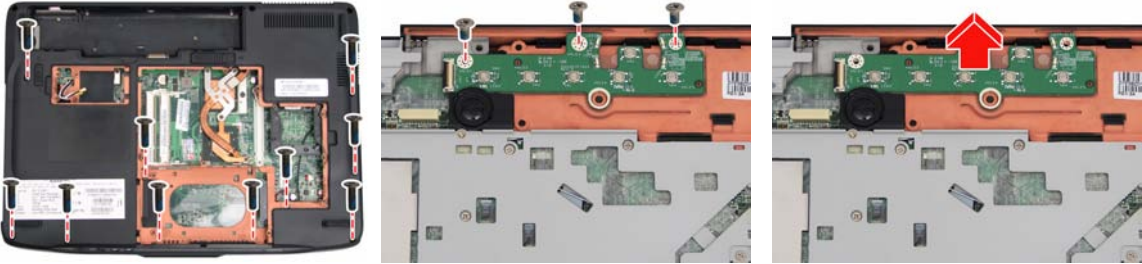

4. Remove the ten screws fastening the upper case assembly to the lower case assembly.
5. Disconnect the touchpad, speaker and bluetooth cables.
6. Gently lift off the upper case assembly from the lower case assembly.

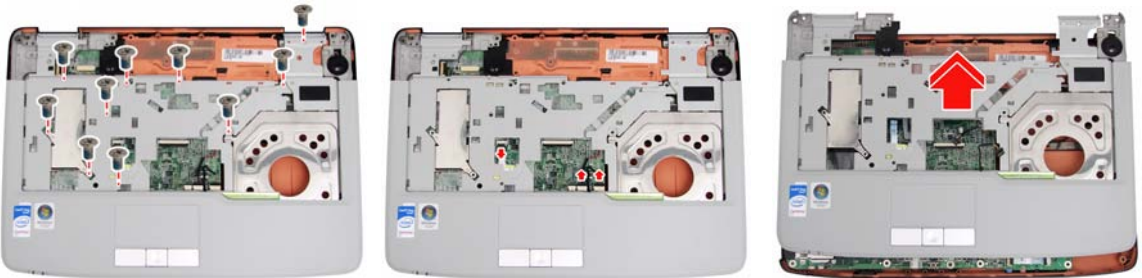

Disassembling the Lower Case Assembly

Removing the Main Board

1. Remove the two screws fastening the main board to the lower case.
2. Disconnect both ends of the audio board FFC cable as shown.
3. Remove the main board.



Removing the Audio Board

4. Remove the screw fastening the audio board.
5. Remove the audio board.



Disassembling the Upper Case Assembly

Removing the Bluetooth Module

1. Remove the two screws fastening the Bluetooth module.
2. Disconnect the Bluetooth cable to remove the Bluetooth module.



Removing the Speakers

3. Remove the three screws fastening the speakers.
4. Remove the speakers.

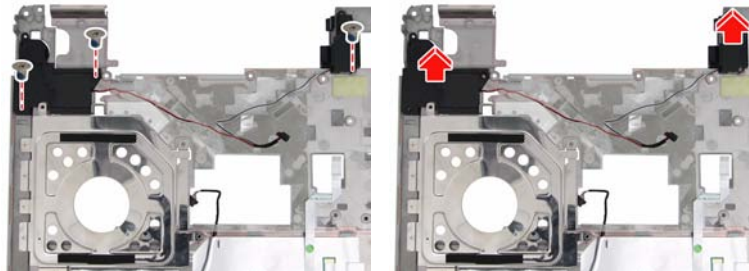

Removing the Touchpad Cable

5. Disconnect the touchpad FFC cable from the touchpad module as shown.



Disassembling the Main Board

Removing the Power Board

1. Remove the two screws fastening the power board.
2. Remove the power board.



Removing the Thermal Module and System Fan

3. Unscrew the six screws fastening the thermal module and system fan.
4. Disconnect the system fan cable and remove the thermal module and system fan as shown.

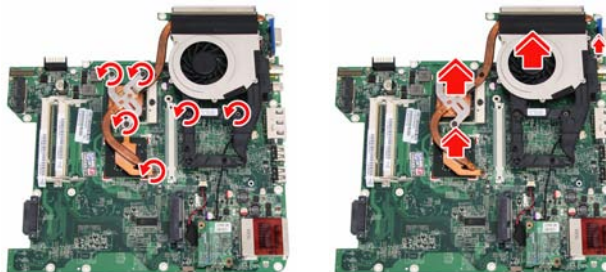

Removing the CPU

5. Use a flat screwdriver to release the CPU lock (Turn counter clockwise).
6. Remove the CPU from the CPU socket carefully.

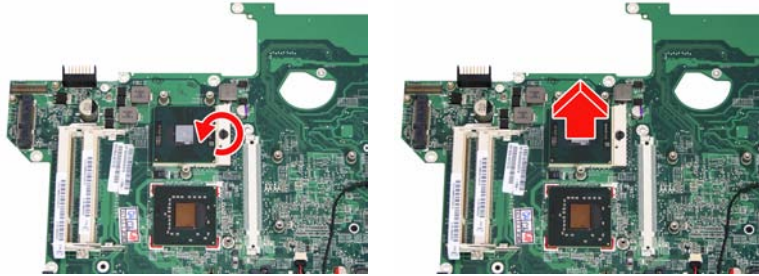

Removing the Modem Card

7. Remove the screw fastening the modem card.
8. Disconnect the modem cable and remove the modem card.

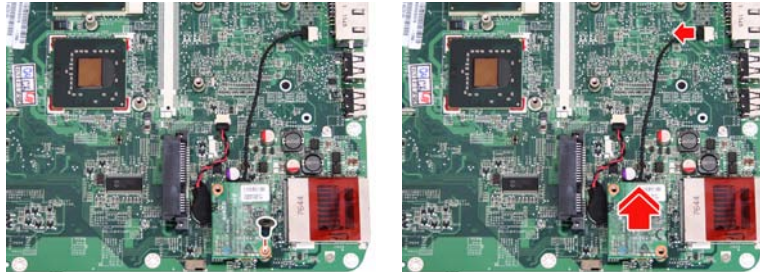

Disassembling the LCD Module

- 1. Remove the six screw rubbers as shown.
- 2. Then remove the six screws fastening the LCD bezel.
- 3. Detach the LCD bezel from the LCD module carefully.



- 4. Remove the four screws holding the LCD.
- 5. Detach the two inverter cable connectors from the inverter board.
- 6. Disconnect the CCD cable connector from the CCD module.

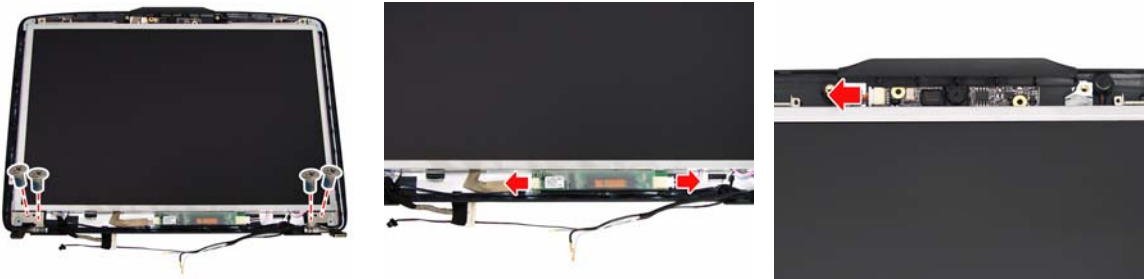

- 7. Take out the LCD from the LCD cover.
- 8. Remove the two screws fastening the left LCD bracket and detach it.
- 9. Remove the two screws fastening the right LCD bracket and detach it.



10. Disconnect the LCD cable from the rear of the LCD.

11. Detach the microphone cable from the LCD cover and remove the microphone.

12. Remove the CCD module from the LCD cover as shown.

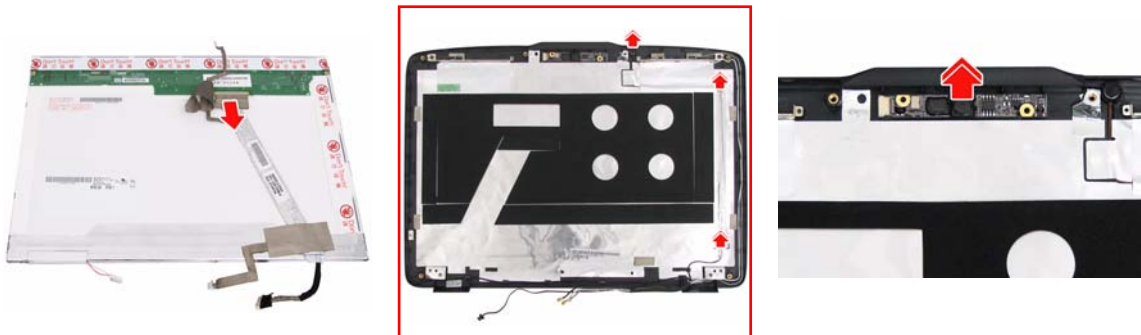

Disassembling the External Modules

Disassembling the HDD Module

1. Remove the two screws fastening the bracket to the HDD module.
2. Remove the bracket.



Disassembling the ODD Module

1. Remove the two screws holding the optical bracket.
2. Then remove the optical bracket from the optical disk drive.



Troubleshooting

Use the following procedure as a guide for computer problems.

NOTE: The diagnostic tests are intended to test only Acer products. Non-Acer products, prototype cards, or modified options can give false errors and invalid system responses.

1. Obtain the failing symptoms in as much detail as possible.
2. Verify the symptoms by attempting to re-create the failure by running the diagnostic test or by repeating the same operation.
3. Use the following table with the verified symptom to determine which page to go to.

Symptoms (Verified)	Go To
Power failure (The power indicator does not go on or stay on).	"Power System Check" on page 69
POST does not complete. No beep or error codes are indicated.	"Power-On Self-Test (POST) Error Message" on page 72 "Undetermined Problems" on page 84
POST detects an error and displayed messages on screen.	"Error Message List" on page 73
Other symptoms (i.e. LCD display problems or others).	"Power-On Self-Test (POST) Error Message" on page 72
Symptoms cannot be re-created (intermittent problems).	Use the customer-reported symptoms and go to "Power-On Self-Test (POST) Error Message" on page 72 "Intermittent Problems" on page 83 "Undetermined Problems" on page 84

System Check Procedures

External Diskette Drive Check

Do the following to isolate the problem to a controller, driver, or diskette. A write-enabled, diagnostic diskette is required.

NOTE: Make sure that the diskette does not have more than one label attached to it. Multiple labels can cause damage to the drive or cause the drive to fail.

Do the following to select the test device:

1. Boot from the diagnostics diskette and start the diagnostics program.
2. See if FDD Test is passed as the program runs to FDD Test.
3. Follow the instructions in the message window.

If an error occurs with the internal diskette drive, reconnect the diskette connector on the system board.

If the error still remains:

1. Reconnect the external diskette drive/DVD-ROM module.
2. Replace the external diskette drive/CD-ROM module.
3. Replace the main board.

External CD-ROM Drive Check

Do the following to isolate the problem to a controller, drive, or CD-ROM. Make sure that the CD-ROM does not have any label attached to it. The label can cause damage to the drive or can cause the drive to fail.

Do the following to select the test device:

1. Boot from the diagnostics diskette and start the diagnostics program.
2. See if CD-ROM Test is passed when the program runs to CD-ROM Test.
3. Follow the instructions in the message window.

If an error occurs, reconnect the connector on the System board. If the error still remains:

1. Reconnect the external diskette drive/CD-ROM module.
2. Replace the external diskette drive/CD-ROM module.
3. Replace the main board.

Keyboard or Auxiliary Input Device Check

Remove the external keyboard if the internal keyboard is to be tested.

If the internal keyboard does not work or an unexpected character appears, make sure that the flexible cable extending from the keyboard is correctly seated in the connector on the system board.

If the keyboard cable connection is correct, run the Keyboard Test.

If the tests detect a keyboard problem, do the following one at a time to correct the problem. Do not replace a non-defective FRU:

1. Reconnect the keyboard cables.
2. Replace the keyboard.
3. Replace the main board.

The following auxiliary input devices are supported by this computer:

- Numeric keypad
- External keyboard

If any of these devices do not work, reconnect the cable connector and repeat the failing operation.

Memory check

Memory errors might stop system operations, show error messages on the screen, or hang the system.

1. Boot from the diagnostics diskette and start the diagnostic program (please refer to main board).
2. Go to the diagnostic memory in the test items.
3. Press F2 in the test items.
4. Follow the instructions in the message window.

NOTE: Make sure that the DIMM is fully installed into the connector. A loose connection can cause an error.

Power System Check

To verify the symptom of the problem, power on the computer using each of the following power sources:

1. Remove the battery pack.
2. Connect the power adapter and check that power is supplied.
3. Disconnect the power adapter and install the charged battery pack; then check that power is supplied by the battery pack.

If you suspect a power problem, see the appropriate power supply check in the following list:

- “Check the Power Adapter” on page 70
- “Check the Battery Pack” on page 71

Check the Power Adapter

Unplug the power adapter cable from the computer and measure the output voltage at the plug of the power adapter cable. See the following figure:

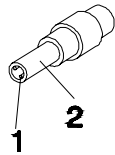

Pin 1: +19 to +20.5V
Pin 2: 0V, Ground

1. If the voltage is not correct, replace the power adapter.
2. If the voltage is within the range, do the following:
 - Replace the System board.
 - If the problem is not corrected, see “Undetermined Problems” on page 84.
 - If the voltage is not correct, go to the next step.

NOTE: An audible noise from the power adapter does not always indicate a defect.

3. If the power-on indicator does not light up, check the power cord of the power adapter for correct continuity and installation.
4. If the operational charge does not work, see “Check the Battery Pack” on page 71.

Check the Battery Pack

To check the battery pack, do the following:

From Software:

1. Check out the Power Management in Control Panel
2. In Power Meter, confirm that if the parameters shown in the screen for Current Power Source and Total Battery Power Remaining are correct.
3. Repeat the steps 1 and 2, for both battery and adapter.
4. This helps you identify first the problem is on recharging or discharging.

From Hardware:

1. Power off the computer.
2. Remove the battery pack and measure the voltage between battery terminals 1(+) and 6(ground). See the following figure

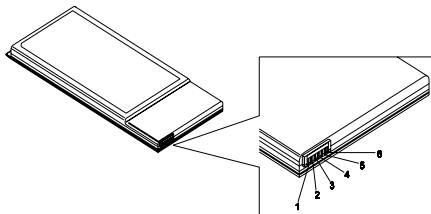

3. If the voltage is still less than 7.5 Vdc after recharging, replace the battery.

To check the battery charge operation, use a discharged battery pack or a battery pack that has less than 50% of the total power remaining when installed in the computer.

If the battery status indicator does not light up, remove the battery pack and let it return to room temperature. Re-install the battery pack.

If the charge indicator still does not light up, replace the battery pack. If the charge indicator still does not light up, replace the DC/DC charger board.

Touchpad Check

If the touchpad doesn't work, do the following actions one at a time to correct the problem. Do not replace a non-defective FRU:

1. Reconnect the touchpad cables.
2. Replace the touchpad.
3. Replace the system board.

After you use the touchpad, the pointer drifts on the screen for a short time. This self-acting pointer movement can occur when a slight, steady pressure is applied to the touchpad pointer. This symptom is not a hardware problem. No service actions are necessary if the pointer movement stops in a short period of time.

Power-On Self-Test (POST) Error Message

The POST error message index lists the error message and their possible causes. The most likely cause is listed first.

NOTE: Perform the FRU replacement or actions in the sequence shown in FRU/Action column, if the FRU replacement does not solve the problem, put the original part back in the computer. Do not replace a non-defective FRU.

This index can also help you determine the next possible FRU to be replaced when servicing a computer.

If the symptom is not listed, see “Undetermined Problems” on page 84.

The following lists the error messages that the BIOS displays on the screen and the error symptoms classified by function.

NOTE: Most of the error messages occur during POST. Some of them display information about a hardware device, e.g., the amount of memory installed. Others may indicate a problem with a device, such as the way it has been configured.

NOTE: If the system fails after you make changes in the BIOS Setup Utility menus, reset the computer, enter Setup and install Setup defaults or correct the error.

Index of Error Messages

Error Code List

Error Codes	Error Messages
006	Equipment Configuration Error Causes: 1. CPU BIOS Update Code Mismatch 2. IDE Primary Channel Master Drive Error (The causes will be shown before "Equipment Configuration Error")
010	Memory Error at xxxx:xxxx:xxxxh (R:xxxxh, W:xxxxh)
070	Real Time Clock Error
071	CMOS Battery Bad
072	CMOS Checksum Error
110	System disabled. Incorrect password is specified.
<No error code>	Battery critical LOW In this situation BIOS will issue 4 short beeps then shut down system, no message will show.
<No error code>	Thermal critical High In this situation BIOS will shut down system, not show message.

Error Message List

Error Messages	FRU/Action in Sequence
Failure Fixed Disk	Reconnect hard disk drive connector. "Load Default Settings" in BIOS Setup Utility. Hard disk drive System board
Stuck Key	see "Keyboard or Auxiliary Input Device Check" on page 68.
Keyboard error	see "Keyboard or Auxiliary Input Device Check" on page 68.
Keyboard Controller Failed	see "Keyboard or Auxiliary Input Device Check" on page 68.
Keyboard locked - Unlock key switch	Unlock external keyboard
Monitor type does not match CMOS - Run Setup	Run "Load Default Settings" in BIOS Setup Utility.
Shadow RAM Failed at offset: nnnn	BIOS ROM System board
System RAM Failed at offset: nnnn	DIMM System board
Extended RAM Failed at offset: nnnn	DIMM System board
System battery is dead - Replace and run Setup	Replace RTC battery and Run BIOS Setup Utility to reconfigure system time, then reboot system.
System CMOS checksum bad - Default configuration used	RTC battery Run BIOS Setup Utility to reconfigure system time, then reboot system.
System timer error	RTC battery Run BIOS Setup Utility to reconfigure system time, then reboot system. System board

Error Message List

Error Messages	FRU/Action in Sequence
Real time clock error	RTC battery Run BIOS Setup Utility to reconfigure system time, then reboot system. System board
Previous boot incomplete - Default configuration used	Run "Load Default Settings" in BIOS Setup Utility. RTC battery System board
Memory size found by POST differed from CMOS	Run "Load Default Settings" in BIOS Setup Utility. DIMM System board
Diskette drive A error	Check the drive is defined with the proper diskette type in BIOS Setup Utility See "External Diskette Drive Check" on page 68.
Incorrect Drive A type - run SETUP	Check the drive is defined with the proper diskette type in BIOS Setup Utility
System cache error - Cache disabled	System board
CPU ID:	System board
DMA Test Failed	DIMM System board
Software NMI Failed	DIMM System board
Fail-Safe Timer NMI Failed	DIMM System board
Device Address Conflict	Run "Load Default Settings" in BIOS Setup Utility. RTC battery System board
Allocation Error for device	Run "Load Default Settings" in BIOS Setup Utility. RTC battery System board
Failing Bits: nnnn	DIMM BIOS ROM System board
Fixed Disk n	None
Invalid System Configuration Data	BIOS ROM System board
I/O device IRQ conflict	Run "Load Default Settings" in BIOS Setup Utility. RTC battery System board
Operating system not found	Enter Setup and see if fixed disk and drive A: are properly identified. Diskette drive Hard disk drive System board

Error Message List

No beep Error Messages	FRU/Action in Sequence
No beep, power-on indicator turns off and LCD is blank.	Power source (battery pack and power adapter). See "Power System Check" on page 69.. Ensure every connector is connected tightly and correctly. Reconnect the DIMM. LED board. System board.
No beep, power-on indicator turns on and LCD is blank.	Power source (battery pack and power adapter). See "Power System Check" on page 69.. Reconnect the LCD connector Hard disk drive LCD inverter ID LCD cable LCD Inverter LCD System board
No beep, power-on indicator turns on and LCD is blank. But you can see POST on an external CRT.	Reconnect the LCD connectors. LCD inverter ID LCD cable LCD inverter LCD System board
No beep, power-on indicator turns on and a blinking cursor shown on LCD during POST.	Ensure every connector is connected tightly and correctly. System board
No beep during POST but system runs correctly.	Speaker System board

Phoenix BIOS Beep Codes

Code	Beeps	POST Routine Description
02h		Verify Real Mode
03h		Disable Non-Maskable Interrupt (NMI)
04h		Get CPU type
06h		Initialize system hardware
08h		Initialize chipset with initial POST values
09h		Set IN POST flag
0Ah		Initialize CPU registers
0Bh		Enable CPU cache
0Ch		Initialize caches to initial POST values
0Eh		Initialize I/O component
0Fh		Initialize the local bus IDE
10h		Initialize Power Management
11h		Load alternate registers with initial POST values
12h		Restore CPU control word during warm boot
13h		Initialize PCI Bus Mastering devices
14h		Initialize keyboard controller
16h	1-2-2-3	BIOS ROM checksum
17h		Initialize cache before memory autosize
18h		8254 timer initialization
1Ah		8237 DMA controller initialization
1Ch		Reset Programmable Interrupt Controller
20h	1-3-1-1	Test DRAM refresh
22h	1-3-1-3	Test 8742 Keyboard Controller
24h		Set ES segment register to 4 GB
26h		Enable A20 line
28h		Autosize DRAM
29h		Initialize POST Memory Manager
2Ah		Clear 215 KB base RAM
2Ch	1-3-4-1	RAM failure on address line xxxx
2Eh	1-3-4-3	RAM failure on data bits xxxx of low byte of memory bus
2Fh		Enable cache before system BIOS shadow
30h	1-4-1-1	RAM failure on data bits xxxx of high byte of memory bus
32h		Test CPU bus-clock frequency
33h		Initialize Phoenix Dispatch Manager
36h		Warm start shut down
38h		Shadow system BIOS ROM
3Ah		Autosize cache
3Ch		Advanced configuration of chipset registers
3Dh		Load alternate registers with CMOS values
42h		Initialize interrupt vectors
45h		POST device initialization

Code	Beeps	POST Routine Description
46h	2-1-2-3	Check ROM copyright notice
48h		Check video configuration against CMOS
49h		Initialize PCI bus and devices
4Ah		Initialize all video adapters in system
4Bh		QuietBoot start (optional)
4Ch		Shadow video BIOS ROM
4Eh		Display BIOS copyright notice
50h		Display CPU type and speed
51h		Initialize EISA board
52h		Test keyboard
54h		Set key click if enabled
58h	2-2-3-1	Test for unexpected interrupts
59h		Initialize POST display service
5Ah		Display prompt "Press F2 to enter SETUP"
5Bh		Disable CPU cache
5Ch		Test RAM between 512 and 640 KB
60h		Test extended memory
62h		Test extended memory address lines
64h		Jump to User Patch1
66h		Configure advanced cache registers
67h		Initialize Multi Processor APIC
68h		Enable external and CPU caches
69h		Setup System Management Mode (SMM) area
6Ah		Display external L2 cache size
6Bh		Load custom defaults (optional)
6Ch		Display shadow-area message
6Eh		Display possible high address for UMB recovery
70h		Display error messages
72h		Check for configuration errors
76h		Check for keyboard errors
7Ch		Set up hardware interrupt vectors
7Eh		Initialize coprocessor if present
80h		Disable onboard Super I/O ports and IRQs
81h		Late POST device initialization
82h		Detect and install external RS232 ports
83h		Configure non-MCD IDE controllers
84h		Detect and install external parallel ports
85h		Initialize PC-compatible PnP ISA devices
86h		Re-initialize onboard I/O ports
87h		Configure Motherboard Configurable Devices (optional)
88h		Initialize BIOS Area
89h		Enable Non-Maskable Interrupts (NMI)
8Ah		Initialize Extended BIOS Data Area
8Bh		Test and initialize PS/2 mouse

Code	Beeps	POST Routine Description
8Ch		Initialize floppy controller
8Fh		Determine number of ATA drives (optional)
90h		Initialize hard-disk controllers
91h		Initialize local-bus hard-disk controllers
92h		Jump to UserPatch2
93h		Build MPTABLE for multi-processor boards
95h		Install CD ROM for boot
96h		Clear huge ES segment register
97h		Fixup Multi Processor table
98h	1-2	Search for option ROMs. One long, two short beeps on checksum failure.
99h		Check for SMART drive (optional)
9Ah		Shadow option ROMs
9Ch		Set up Power Management
9Dh		Initialize security engine (optional)
9Eh		Enable hardware interrupts
9Fh		Determine number of ATA and SCSI drives
A0h		Set time of day
A2h		Check key lock
A4h		Initialize Typematic rate
A8h		Erase F2 prompt
AAh		Scan for F2 key stroke
ACh		Enter SETUP
AEh		Clear Boot flag
B0h		Check for errors
B2h		POST done- prepare to boot operating system
B4h	1	One short beep before boot
B5h		Terminate QuietBoot (optional)
B6h		Check password (optional)
B9h		Prepare Boot
BAh		Initialize DMI parameters
BBh		Initialize PnP Option ROMs
BCh		Clear parity checkers
BDh		Display MultiBoot menu
BEh		Clear screen (optional)
BFh		Check virus and backup reminders
C0h		Try to boot with INT 19
C1h		Initialize POST Error Manager (PEM)
C2h		Initialize error logging
C3h		Initialize error display function
C4h		Initialize system error handler
C5h		PnPnd dual CMOS (optional)
C6h		Initialize notebook docking (optional)
C7h		Initialize notebook docking late
C8h		Force check (optional)
C9h		Extended checksum (optional)

Code	Beeps	POST Routine Description
D2h		Unknown interrupt

Code	Beeps	POST Routine Description
E0h		Initialize the chipset
E1h		Initialize the bridge
E2h		Initialize the CPU
E3h		Initialize the system timer
E4h		Initialize system I/O
E5h		Check force recovery boot
E6h		Checksum BIOS ROM
E7h		Go to BIOS
E8h		Set Huge Segment
E9h		Initialize Multi Processor
EAh		Initialize OEM special code
EBh		Initialize PIC and DMA
ECh		Initialize Memory type
EDh		Initialize Memory size
EEh		Shadow Boot Block
EFh		System memory test
F0h		Initialize interrupt vectors
F1h		Initialize Run Time Clock
F2h		Initialize video
F3h		Initialize System Management Mode
F4h	1	Output one beep before boot
F5h		Boot to Mini DOS
F6h		Clear Huge Segment
F7h		Boot to Full DOS

Index of Symptom-to-FRU Error Message

LCD-Related Symptoms

Symptom / Error	Action in Sequence
LCD backlight doesn't work LCD is too dark LCD brightness cannot be adjusted LCD contrast cannot be adjusted	Enter BIOS Utility to execute "Load Setup Default Settings", then reboot system. Reconnect the LCD connectors. Keyboard (if contrast and brightness function key doesn't work). LCD inverter ID LCD cable LCD inverter LCD System board
Unreadable LCD screen Missing pels in characters Abnormal screen Wrong color displayed	Reconnect the LCD connector LCD inverter ID LCD cable LCD inverter LCD System board
LCD has extra horizontal or vertical lines displayed.	LCD inverter ID LCD inverter LCD cable LCD System board

Indicator-Related Symptoms

Symptom / Error	Action in Sequence
Indicator incorrectly remains off or on, but system runs correctly	Reconnect the inverter board Inverter board System board

Power-Related Symptoms

Symptom / Error	Action in Sequence
Power shuts down during operation	Power source (battery pack and power adapter). See "Power System Check" on page 69. Battery pack Power adapter Hard drive & battery connection board System board
The system doesn't power-on.	Power source (battery pack and power adapter). See "Power System Check" on page 69. Battery pack Power adapter Hard drive & battery connection board System board
The system doesn't power-off.	Power source (battery pack and power adapter). See "Power System Check" on page 69. Hold and press the power switch for more than 4 seconds. System board

Power-Related Symptoms

Symptom / Error	Action in Sequence
Battery can't be charged	See "Check the Battery Pack" on page 71. Battery pack System board

PCMCIA-Related Symptoms

Symptom / Error	Action in Sequence
System cannot detect the PC Card (PCMCIA)	PCMCIA slot assembly System board
PCMCIA slot pin is damaged.	PCMCIA slot assembly

Memory-Related Symptoms

Symptom / Error	Action in Sequence
Memory count (size) appears different from actual size.	Enter BIOS Setup Utility to execute "Load Default Settings, then reboot system. DIMM System board

Speaker-Related Symptoms

Symptom / Error	Action in Sequence
In Windows, multimedia programs, no sound comes from the computer.	Audio driver Speaker System board
Internal speakers make noise or emit no sound.	Speaker System board

Power Management-Related Symptoms

Symptom / Error	Action in Sequence
The system will not enter hibernation	See "Save to Disk (S4)" on page 38. Keyboard (if control is from the keyboard) Hard disk drive System board
The system doesn't enter hibernation mode and four short beeps every minute.	Press Fn+ F4 and see if the computer enters hibernation mode. Touchpad Keyboard Hard disk connection board Hard disk drive System board
The system doesn't enter standby mode after closing the LCD	See "Save to Disk (S4)" on page 38. LCD cover switch System board
The system doesn't resume from hibernation mode.	See "Save to Disk (S4)" on page 38. Hard disk connection board Hard disk drive System board
The system doesn't resume from standby mode after opening the LCD.	See "Save to Disk (S4)" on page 38. LCD cover switch System board

Power Management-Related Symptoms

Symptom / Error	Action in Sequence
Battery fuel gauge in Windows doesn't go higher than 90%.	Remove battery pack and let it cool for 2 hours. Refresh battery (continue use battery until power off, then charge battery). Battery pack System board
System hangs intermittently.	Reconnect hard disk/CD-ROM drives. Hard disk connection board System board

Peripheral-Related Symptoms

Symptom / Error	Action in Sequence
System configuration does not match the installed devices.	Enter BIOS Setup Utility to execute "Load Default Settings", then reboot system. Reconnect hard disk/CD-ROM/diskette drives.
External display does not work correctly.	Press Fn+F5, LCD/CRT/Both display switching System board
USB does not work correctly	System board
Print problems.	Ensure the "Parallel Port" in the "Onboard Devices Configuration" of BIOS Setup Utility is set to Enabled. Onboard Devices Configuration Run printer self-test. Printer driver Printer cable Printer System Board
Serial or parallel port device problems.	Ensure the "Serial Port" in the Devices Configuration" of BIOS Setup Utility is set to Enabled. Device driver Device cable Device System board

Keyboard/Touchpad-Related Symptoms

Symptom / Error	Action in Sequence
Keyboard (one or more keys) does not work.	Reconnect the keyboard cable. Keyboard System board
Touchpad does not work.	Reconnect touchpad cable. Touchpad board System board

Modem-Related Symptoms

Symptom / Error	Action in Sequence
Internal modem does not work correctly.	Modem phone port modem combo board System board

NOTE: If you cannot find a symptom or an error in this list and the problem remains, see "Undetermined Problems" on page 84.

Intermittent Problems

Intermittent system hang problems can be caused by a variety of reasons that have nothing to do with a hardware defect, such as: cosmic radiation, electrostatic discharge, or software errors. FRU replacement should be considered only when a recurring problem exists.

When analyzing an intermittent problem, do the following:

1. Run the advanced diagnostic test for the system board in loop mode at least 10 times.
2. If no error is detected, do not replace any FRU.
3. If any error is detected, replace the FRU. Rerun the test to verify that there are no more errors.

Undetermined Problems

The diagnostic problems does not identify which adapter or device failed, which installed devices are incorrect, whether a short circuit is suspected, or whether the system is inoperative.

Follow these procedures to isolate the failing FRU (do not isolate non-defective FRU).

NOTE: Verify that all attached devices are supported by the computer.

NOTE: Verify that the power supply being used at the time of the failure is operating correctly. (See "Power System Check" on page 69.):

1. Power-off the computer.
2. Visually check them for damage. If any problems are found, replace the FRU.
3. Remove or disconnect all of the following devices:
 - Non-Acer devices
 - Printer, mouse, and other external devices
 - Battery pack
 - Hard disk drive
 - DIMM
 - CD-ROM/Diskette drive Module
 - PC Cards
4. Power-on the computer.
5. Determine if the problem has changed.
6. If the problem does not recur, reconnect the removed devices one at a time until you find the failing FRU.
7. If the problem remains, replace the following FRU one at a time. Do not replace a non-defective FRU:
 - System board
 - LCD assembly

Jumper and Connector Locations

Top View

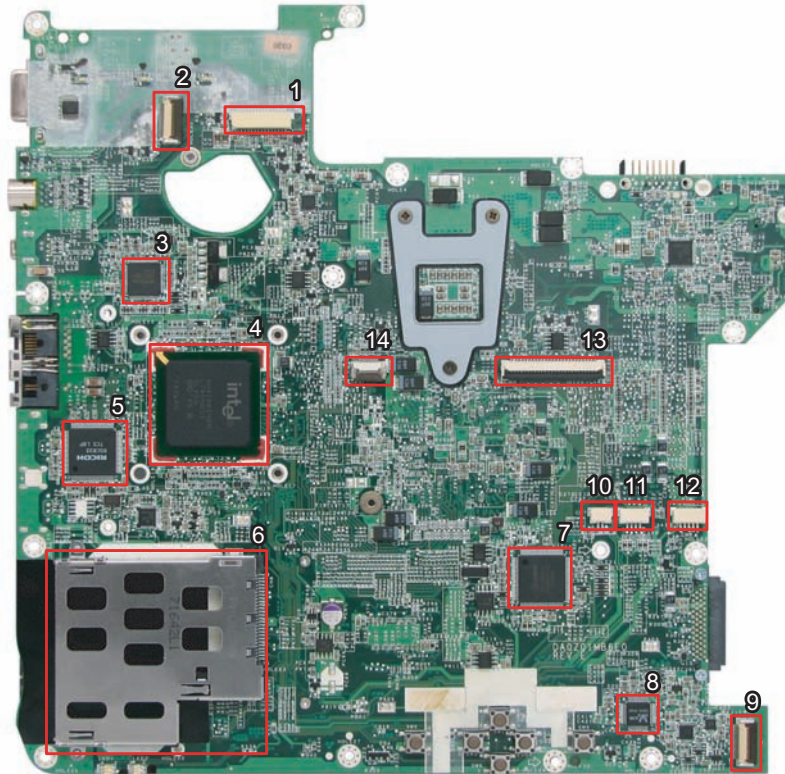

1	CN1	LVDS Connector	8	U17	Audio Codec (ALC 268)
2	CN2	Switch Board Connector	9	CN9	Audio Board Connector
3	U2	BCM5787	10	CN7	Microphone Connector
4	U6	South Bridge (ICH8M)	11	CN5	Speaker Connector
5	U8	PCI Card Reader Controller (RICOH R5C833)	12	CN6	Bluetooth Connector
6	CN8	Express Card Socket	13	CN3	Keyboard Connector
7	U13	Winbond Keyboard Controller (WPC9769LDG)	14	CN4	Touchpad Connector

Bottom View

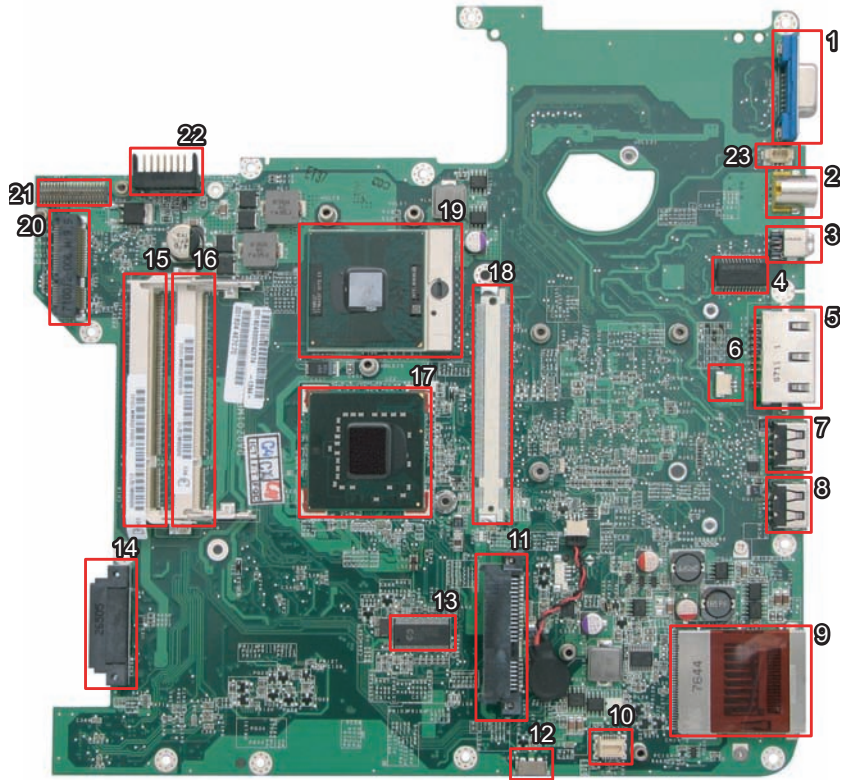

1	CN10	VGA Connector	13	U26	Clock Generator
2	CN11	S-Video Connector	14	CN26	Optical Disk Drive Connector
3	CN13	Ethernet Controller (BCM5787)	15	CN18	DIMM Socket
4	U20	LAN Transform	16	CN19	DIMM Socket
5	CN16	RJ45/RJ11 Jack	17	U22	North Bridge (965PM/GM)
6	CN17	Modem Cable Connector	18	CN20	MXM Connector (for selected models only)
7	CN21	USB Connector	19	U21	CPU Socket
8	CN22	USB Connector	20	CN14	Mini Card Socket
9	CN28	5-in-1 Card Reader	21	CN12	Power Board Connector
10	CN31	Modem Card Connector	22	PJ1	Battery Connector
11	CN27	SATA HDD Connector	23	CN15	Fan Connector
12	U28	Consumer Infrared Receiver			

FRU (Field Replaceable Unit) List









This chapter gives you the FRU (Field Replaceable Unit) listing in global configurations of Aspire 4720G/4720Z/4720/4320 series. Refer to this chapter whenever ordering for parts to repair or for RMA (Return Merchandise Authorization).









Please note that WHEN ORDERING FRU PARTS, you should check the most up-to-date information available on your regional web or channel. For whatever reasons a part number change is made, it will not be noted on the printed Service Guide. For ACER AUTHORIZED SERVICE PROVIDERS, your Acer office may have a DIFFERENT part number code from those given in the FRU list of this printed Service Guide. You MUST use the local FRU list provided by your regional Acer office to order FRU parts for repair and service of customer machines.

NOTE: To scrap or to return the defective parts, you should follow the local government ordinance or regulations on how to dispose it properly, or follow the rules set by your regional Acer office on how to return it.

Aspire 4720G/4720Z/4720/4320 Exploded Diagram

Category	No.	Part Name and Description	Acer Part No.
ADAPTER			
		ADAPTER 90W 3 PIN DELTA ADP-90SB BBDHF ROHS	AP.09001.008
		ADAPTER 90W 3 PIN LITEON PA-1900-04QB ROHS	AP.09003.009
		ADAPTER 65W 3 PIN LITE-ON PA1650-02 QY LF	AP.06503.013
		ADAPTER 65W 3 PIN Delta SADP-65KB DBRF LF	AP.06501.010
BATTERY			
		Battery SANYO AS-2007A Li-Ion 3S2P SANYO 6 cell 4000mAh Main COMMON Y Cell	BT.00603.036
		Battery SONY AS-2007A Li-Ion 3S2P SONY 6 cell 4000mAh Main COMMON G4E Cell	BT.00604.022
		Battery PANASONIC AS-2007A Li-Ion 3S2P PANASONIC 6 cell 4000mAh Main COMMON PSS Cell	BT.00605.018
		Battery SIMPLO AS-2007A Li-Ion 3S2P PANASONIC 6 cell 4000mAh Main COMMON PSS Cell	BT.00607.013
		Battery SANYO AS-2007A Li-Ion 3S2P SANYO 6 cell 4800mAh Main COMMON	BT.00603.037
		Battery SONY AS-2007A Li-Ion 3S2P SONY 6 cell 4800mAh Main COMMON	BT.00604.023
		Battery SIMPLO AS-2007A Li-Ion 3S2P PANASONIC 6 cell 4800mAh Main COMMON	BT.00607.014
BOARD			
		MODEM BOARD FOXCONN T60M951.00	FX.22500.004
		BLUETOOTH MODULE (T60H928.01)	54.TAXV7.001
		MINI PCI WIRELESS BOARD 802.11 A/ B/G MOW1 INTEL MM872612	KI.GLN01.001
		MINI PCI WIRELESS BOARD 802.11 A/ B/G MOW2 INTEL MM872659	KI.GLN01.002
		MINI PCI WIRELESS BOARD 802.11 A/ B/G ROW INTEL MM874511	KI.GLN01.003
		MINI PCI WIRELESS BOARD 802.11 A/ B/G JPN	KI.GLN01.004

Category	No.	Part Name and Description	Acer Part No.
		WIRELESS LAN BOARD 802.11BG INTEL 3945BG	KI.GLN01.005
		INTEL WIRELESS WIFI LINK 4965ANG MOW1 (MM#886224)	KI.KDN01.001
		INTEL WIRELESS WIFI LINK 4965ANG MOW2 (MM#886220)	KI.KDN01.002
		INTEL WIRELESS WIFI LINK 4965ANG ROW (MM#886434)	KI.KDN01.003
		INTEL WIRELESS WIFI LINK 4965ANG JP (MM#886437)	KI.KDN01.004
		POWER BOARD 65W	55.AK907.001
		POWER BOARD 90W	55.AK907.002
		AUDIO BOARD	55.AK907.003
		SWITCH BOARD	55.AK907.004
		VGA CARD MSI NVIDIA NB8M-SE 128MB MXM I W/O HDCP	VG.8MS06.001
CABLE			
		PWR CORD V943B30001218008 DANISH 3P	27.A03V7.006
		PWR CORD(ISR)1.8M 3PBLK FZ0I0008-038	27.A50V7.002
		PWR CORD V50CB3T3012180QD TW- 110V,3P	27.A99V7.002
		POWER CORD(SWI)1.8M 3PBLACK FZ010008-011	27.A99V7.004
		POWER CORD(IT) 1.8M 3PBLACK FZ010008-008	27.A99V7.005
		POWER CORD(S.A) 1.8M 3BLACK FZ010008-006	27.T48V7.001
		POWER CORD US 3PIN ROHS	27.TAXV7.001
		POWER CORD(EU) 1.8M 3PBLACK FM010008-010	27.TATV7.001
		POWER CORD(UK) 1.8M 3PBLACK FP010008-013	27.TATV7.003
		MODEM CABLE	50.AHS07.001
		FFC CABLE - AUDIO TO MB	50.AHS07.002
		FFC CABLE - SWITCH TO MB	50.AHS07.003









Category	No.	Part Name and Description	Acer Part No.
CASE/COVER/BRACKET ASSEMBLY			
		MIDDLE COVER	42.AHS07.001
		UPPER CASE ASSY W/SPEAKER BLUETOOTH CABLE TP FFC TP	60.AK907.001
		LOWER CASE ASSY W/RUBBER	60.AHS07.002
		BASE DOOR W/RUBBER	42.AHS07.002
		MINI DOOR ASSY	42.AHS07.003
		DUMMY EXPRESS CARD	
		DUMMY 4 IN 1 CARD	42.TG607.005
CPU/PROCESSOR			
		CPU Intel Core2Dual T7100 PGA 1.8G 2M 800 SLA4A	KC.71001.DTP
		CPU Intel Core2Dual T7300 PGA 2.0G 4M 800 SLA45	KC.73001.DTP
		CPU Intel Core2Dual T7500 PGA 2.2G 4M 800 SLA44	KC.75001.DTP
COMBO MODULE			
		DVD/CDRW COMBO MODULE	6M.AHS07.001
		DVD/CDRW COMBO DRIVE 24X SONY CRX880A LF W/O BEZEL	KO.0240E.005
		DVD/CDRW COMBO DRIVE 24X HLDS GCC-T10N PATA LF W/O BEZEL	KO.0240D.005
		OPTICAL BRACKET	33.AHS07.002
		DVD/CDRW COMBO BEZEL	42.AHS07.004



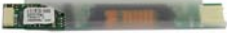

Category	No.	Part Name and Description	Acer Part No.
DVD-RW DRIVE			
		DVD/RW SUPER MULTI MODULE	6M.AHS07.002
		DVD SUPER MULTI TRAY IN HLDS GSA-T20N LF W/O BEZEL	KU.0080D.027
		DVD SUPER MULTI DRIVE PANASONIC UJ-850UAA1-A VISTA FW :1.60	KU.00807.051
		DVD SUPER MULTI DRIVE SONY AD- 7530A VISTA TRAY IN	KU.0080E.002
		DVD SUPER MULTI TRAY IN PHILIPS DS-8A1P LF W/O BEZEL	KU.00809.010
		OPTICAL BRACKET	33.AHS07.002
		DVD SUPER MULTI BEZEL	42.AGW07.003
HDD/HARD DISK DRIVE			
		80GB HGST 2.5" 5400RPM SATA HTS541680J9SA00 SURUGA-B LF F/ W: C70P	KH.08007.021
		120GB HGST 2.5" 5400RPM SATA HTS541612J9SA00 SURUGA-B LF F/ W: C70P	KH.12007.010
		HDD SATA 120G 5400RPM SEAGATE ST9120822AS SATA 8MB LF 3.ALD	KH.12001.031
		120GB TOSHIBA 2.5" 5400rpm 120GB MK1237GSX Gemini BS SATA LF F/ W:DL130J	KH.12004.006
		HDD WD 2.5" 5400RPM 120GB WD1200BEVS-22RST0 ML80 SATA LF F/W:04.01G04	KH.12008.018
		160G SEAGATE 2.5" 5400RPM ST9160821AS VENUS SATA LF FW: 3.ALA	KH.16001.026
		160GB HGST 2.5" 5400RPM SATA HTS541616J9SA00 SURUGA-B LF F/ W: C70P	KH.16007.011
		160GB TOSHIBA 2.5" 5400rpm 160GB MK1637GSX Gemini BS SATA LF F/W: DL030J	KH.16004.001
		160GB WD 2.5" 5400rpm 160GB WD1600BEVS-22RST0 ML80 SATA LF F/W:04.01G04	KH.16008.019
		HDD WD 2.5" 5400RPM 80GB WD800BEVS-22RST0 ML80 SATA LF F/ W:04.01G04	KH.08008.033
		HDD SATA 80G 5400RPM SEAGATE ST980811AS SATA 8MB LF 3.ALD	KH.08001.030
		HDD SATA 80G 5400RPM TOSHIBA MK8037GSX Gemini BS SATA LF F/ W:DL230J	KH.08004.010

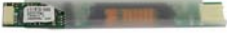
Category	No.	Part Name and Description	Acer Part No.
		HDD BRACKET ASSY	33.AHS07.003
KEYBOARD			
		KEYBOARD 14_15KB-FV2 88KS WHITE US INTERNATIONAL	KB.INT00.036
		KEYBOARD 14_15KB-FV2 88KS WHITE TRADITIONAL CHINESE	KB.INT00.065
		KEYBOARD 14_15KB-FV2 89KS WHITE GREEK	KB.INT00.058
		KEYBOARD 14_15KB-FV2 88KS WHITE THAILAND	KB.INT00.040
		KEYBOARD 14_15KB-FV2 89KS WHITE SLO/CRO	KB.INT00.046
		KEYBOARD 14_15KB-FV2 89KS WHITE CZECH	KB.INT00.064
		KEYBOARD 14_15KB-FV2 89KS WHITE HUNGARIAN	KB.INT00.057
		KEYBOARD 14_15KB-FV2 89KS WHITE POLISH	KB.INT00.049
		KEYBOARD 14_15KB-FV2 89KS WHITE BRAZILIAN PORTUGUESE	KB.INT00.067
		KEYBOARD 14_15KB-FV2 88KS WHITE RUSSIAN	KB.INT00.047
		KEYBOARD 14_15KB-FV2 WHITE 15.4 SLOVAK	KB.INT00.045
		KEYBOARD 14_15KB-FV2 89KS WHITE TURKISH	KB.INT00.039
		KEYBOARD 14_15KB-FV2 89KS WHITE BELGIUM	KB.INT00.068
		KEYBOARD 14_15KB-FV2 89KS WHITE SWEDISH	KB.INT00.042
		KEYBOARD 14_15KB-FV2 89KS WHITE UK	KB.INT00.038
		KEYBOARD 14_15KB-FV2 89KS WHITE FRENCH	KB.INT00.060
		KEYBOARD 14_15KB-FV2 89KS WHITE GERMAN	KB.INT00.059
		KEYBOARD 14_15KB-FV2 89KS WHITE DUTCH	KB.INT00.062
		KEYBOARD 14_15KB-FV2 89KS WHITE ITALIAN	KB.INT00.054
		KEYBOARD 14_15KB-FV2 93KS WHITE JAPANESE	KB.INT00.053
		KEYBOARD 14_15KB-FV2 89KS WHITE CANADIAN FRENCH	KB.INT00.066
		KEYBOARD 14_15KB-FV2 89KS WHITE DANISH	KB.INT00.063
		KEYBOARD 14_15KB-FV2 89KS WHITE SPANISH	KB.INT00.043
	KEYBOARD 14_15KB-FV2 88KS WHITE ARABIC/ENGLISH	KB.INT00.069	

Category	No.	Part Name and Description	Acer Part No.
		KEYBOARD 14_15KB-FV2 89KS WHITE SWISS/G	KB.INT00.041
		KEYBOARD 14_15KB-FV2 89KS WHITE PORTUGUESE	KB.INT00.048
		KEYBOARD 14_15KB-FV2 88KS WHITE US INTERNATIONAL HEBREW	KB.INT00.037
		KEYBOARD 14_15KB-FV2 88KS WHITE KOREAN	KB.INT00.052
		KEYBOARD 14_15KB-FV2 89KS WHITE NORWEGIAN	KB.INT00.050
LCD			
		LCD MODULE ASSY 14.1 IN WXGAG W/ANTENNA W/0.3M CCD	6M.AK907.001
		LCD 14.1" WXGA AU B141EW04-V4 LF GLARE 200NITS 16MS	LK.14105.018
		INVERTER BOARD	19.AGW07.001
		LCD CABLE FOR CCD	50.AHS07.004
		LCD COVER ASSY W/MIC W/ ANTENNA	60.AHS07.003
		LCD BEZEL ASSY FOR CCD	60.AHS07.004
		LCD BRACKET W/HINGE - L	33.AHS07.004

Category	No.	Part Name and Description	Acer Part No.
		LCD BRACKET W/HINGE - R	33.AHS07.005
		CCD MODULE 0.3M BISON	57.TG607.001
		CCD MODULE 0.3M SUYIN	57.TG607.002
		LCD MODULE ASSY 14.1 IN WXGA W/ ANTENNA W/0.3M CCD	6M.AK907.002
		LCD 14.1 IN. WXGA LPL LP141WX1-TLA1 16MS	LK.14108.006
		LCD 14.1" WXGA AU B141EW04-V3 LF NONE GLARE 200NITS 16MS	LK.14105.019
		LCD 14.1 IN. SAMSUNG WXGA LTN141W3-L01-0 16MS 200NITS	LK.14106.010
		INVERTER BOARD	19.AGW07.001
		LCD CABLE FOR CCD	50.AHS07.004
		LCD COVER ASSY W/MIC W/ ANTENNA	60.AHS07.003
		LCD BEZEL ASSY FOR CCD	60.AHS07.004
		LCD BRACKET W/HINGE - L	33.AHS07.004
		LCD BRACKET W/HINGE - R	33.AHS07.005

Category	No.	Part Name and Description	Acer Part No.
		CCD MODULE 0.3M BISON	57.TG607.001
		CCD MODULE 0.3M SUYIN	57.TG607.002
		LCD MODULE ASSY 14.1 IN WXGAG W/ANTENNA W/O CCD	6M.AKD07.001
		LCD 14.1" WXGA AU B141EW04-V4 LF GLARE 200NITS 16MS	LK.14105.018
		INVERTER BOARD	19.AGW07.001
		LCD CABLE W/O CCD	50.AJN07.001
		LCD COVER ASSY W/MIC W/ ANTENNA	60.AHS07.003
		LCD BEZEL ASSY W/O CCD	60.AJN07.001
		LCD BRACKET W/HINGE - L	33.AHS07.004
		LCD BRACKET W/HINGE - R	33.AHS07.005
		LCD MODULE ASSY 14.1 IN WXGA W/ ANTENNA W/O CCD	6M.AKD07.002
		LCD 14.1 IN. WXGA LPL LP141WX1-TLA1 16MS	LK.14108.006
		LCD 14.1" WXGA AU B141EW04-V3 LF NONE GLARE 200NITS 16MS	LK.14105.019
		LCD 14.1 IN. SAMSUNG WXGA LTN141W3-L01-0 16MS 200NITS	LK.14106.010
		INVERTER BOARD	19.AGW07.001
		LCD CABLE W/O CCD	50.AJN07.001
		LCD COVER ASSY W/MIC W/ ANTENNA	60.AHS07.003

Category	No.	Part Name and Description	Acer Part No.
		LCD BEZEL ASSY W/O CCD	60.AJN07.001
		LCD BRACKET W/HINGE - L	33.AHS07.004
		LCD BRACKET W/HINGE - R	33.AHS07.005
MAINBOARD			
		MAINBOARD 960GML UMA W/CARD READRE EXPRESS CARD W/O CPU MOMERY	MB.AKD06.001
		MAINBOARD 965GM UMA W/CARD READRE EXPRESS CARD W/O CPU MOMERY	MB.AKD06.002
		MAINBOARD 965PM DISCRETE W/ CARD READRE EXPRESS CARD W/O CPU MOMERY	MB.AKD06.003
MEMORY			
		Memory HYNIX SO-DIMM DDRII 667 1GB HYMP512S64CP8-Y5 LF	KN.1GB0G.006
		MEMORY 512MB DDR II 667 HYNIX HYMP564S64CP6-Y5 LF (.08UM)	KN.5120G.019
		SO-DIMM DDRII667 512MB NT512T64UH8B0FN-37C (0.09U)\NANYA	KN.51203.032
		SO-DIMM DDRII667 SAMSUNG 512MB M470T6554EZ3-CE6 LF	KN.5120B.023
		1GB NANYA DDRII 667 1GB NT1GT64U8HB0BN-3C (0.09U)	KN.1GB03.014
		1GB SAMSUNG DDRII 667 1GB M470T2953EZ3-CE6 LF	KN.1GB0B.011
HEATSINK			
		THERMAL MODULE - UMA	60.AK907.002
		THERMAL MODULE - DISCRETE	60.AK907.003
MISCELLANEOUS			
		NAME PLATE AS4720	40.AK907.001
		NAME PLATE AS4320	40.AKJ07.001
		LCD BEZEL RUBBER	47.AHS07.001
		LOWER CASE RUBBER FOOT	47.AHS07.002
		BASE DOOR RUBBER FOOT	47.AHS07.003
SCERW			
		SCREW M2.0*3.0-I-NI-NYLOK	86.A08V7.005
		SCREW M2.5*4.0-I(NI)(NYLOK)	86.D01V7.001
		SCREW M2.5*3.5-I(BNI)(NYLOK)	86.AHS07.001
		SCREW M1.6*3-I(NI)(NYLOK)	86.AHS07.002
		SCREW M2.5 *7L-BNI-NYLOK	86.A10V7.006