

KORG

Digital Recording Studio

D8



Owner's Manual

Thank you for purchasing the *Korg Digital Recording Studio D8*.
In order to enjoy many years of trouble-free use, please read this manual carefully and use the unit correctly.

About this owner's manual

This owner's manual is organized as follows.

Chapter 1 Introduction

This chapter explains the main features of the D8, its front and rear panel, and basic operation.

Chapter 2 Operation

This chapter explains various methods of recording and playback, and the procedures for mixdown and editing.

Chapter 3 Reference

This chapter explains the parameters which appear in the display when you press each of the D8's keys, and the operation of the keys and faders.

Chapter 4 Appendices

This chapter contains information such as the D8's specifications, error messages, block diagrams, and lists of effect programs and metronome types.

Display

Some pages of the manual show display screens along with an explanation of functions and operations. All song names, parameter names, and values are merely examples and may not always match the actual display you are working on.

Handling of the internal hard disk

Do not apply physical shock to this device. In particular, you must be very careful to avoid moving the device or jarring the device while it is powered-on. Such actions can cause part or all of the data on disk to be lost, and may damage the hard disk or the interior mechanism.

Do not repeatedly turn the unit on and off. This can damage not only the device itself, but also any other SCSI devices which are connected.

Never turn off the power when the HDD access indicator is lit or blinking. This can damage part or all of the data on disk, or cause malfunctions such as damage to the hard disk.

■ *This device will begin accessing the hard disk immediately after the power is turned on.* At this time, the HDD access indicator will blink, and the display will indicate "Working." *Never turn off the power until the song name appears in the display and the HDD access indicator goes dark.* The length of time that the hard disk is accessed after power-on will depend on the capacity of the hard disk and on the amount of data on the disk.

■ If hard disk access continues (e.g., sound continues to be heard) even after playback or recording operations have been halted, do not turn off the power until the HDD access indicator has stopped blinking. In such cases, it is possible that access may not stop for several minutes or several tens of minutes.

If damage to the hard disk occurs due to incorrect operation, a power failure, or an accidental interruption of the power supply, a fee may be charged for repair even if the unit is still under warranty.

Table of Contents

Precautions	ii
Data handling.....	ii
About this owner's manual.....	iii
Handling of the internal hard disk	iii

Chapter 1 Introduction..... 1

Main features of the D8	1
Front and rear panel.....	2
About the display	6

Chapter 2 Operation..... 7

STEP1 Connections, Power-on, Demo 7 |

1. Connections to your audio system etc.	7
2. Power on/off.....	8
3. Listening to the demo songs.....	8

STEP2 Creating and selecting songs..... 9

1. Creating a new song	9
2. Naming a song.....	9
Selecting another song.....	9

STEP3 Recording..... 10

1. Recording (analog recording).....	10
2. Recording (digital recording)	11
3. Using EQ to modify the tone as you record.....	11
4. Applying an effect to the input sound as you record.....	12
5. Applying an effect to the input sound and recording only the input sound.....	13
6. Applying the dedicated delay to the input sound.....	14
7. Listening to recorded tracks while you record another track (Overdubbing)	14
8. Manually re-recording part of the performance (Manual Punch In/Out).....	15
Canceling a recording or editing operation (Undo/Redo).....	15
9. Automatically re-recording part of the performance (Auto Punch In/Out)	16
10. Combining multiple tracks into one or two tracks (Bounce)	17
11. Listening to the metronome while you record	19
12. Trigger recording	20

STEP4 Playback 20 |

1. Playback.....	20
2. Playing a specified area of a song once or repeatedly	20
3. Applying an effect to the playback sound.....	21
4. Applying an external effect to the playback sound.....	21
5. Program playback of songs.....	22
6. Switching scenes during playback.....	22

STEP5 Moving and storing time locations	22
1. Moving the current time.....	22
2. Finding a precise time location.....	23
3. Locate points (LOC1, LOC2, LOC3)	23
4. Mark points	24
STEP6 Adjusting and storing mixer settings	25
1. Pairing settings	25
2. Adjusting the volume of each channel	25
3. Adjusting the stereo location	26
4. Using the EQ to adjust the tone.....	26
5. Adjusting the Effect Send, AUX Send and Track Status	26
6. Scene.....	27
STEP7 Mixdown	28
1. Recording a master tape (Mixdown)	28
2. Applying an effect during mixdown.....	28
STEP8 Track editing	29
1. Storing IN, OUT and TO times.....	29
2. Copying track data (Track Copy).....	29
3. Inserting a blank space into the track data (Insert Track)	31
4. Erasing data from a track (Erase Track)	31
5. Deleting data from a track (Delete Track).....	32
6. Exchanging data between tracks (Swap Track)	32
STEP9 Song editing	33
1. Copying a song	33
2. Deleting a song	33
3. Moving a song.....	33
4. Song Recover.....	33
STEP10 Tempo settings	34
1. Tempo map settings.....	34
2. Recording MIDI Clock data from a sequencer.....	34
3. Recording tap tempo.....	35
4. Selecting the tempo source.....	35
STEP11 Synchronization and control with a MIDI sequencer	36
1. Using MIDI Clock to synchronize a MIDI sequencer to the D8.....	36
2. Using MTC to synchronize a MIDI sequencer to the D8.....	36
3. Using MMC to control the D8 from a MIDI sequencer	37
STEP12 Using external drives	37
1. Connecting an external drive.....	37
2. Turning the power on/off when an external drive is connected	38
3. Initializing and formatting a drive.....	38
4. Exchanging disks on a removable disk drive.....	38
5. Saving a song on a removable disk drive (Backup)	39
6. Loading a song that was backed up on a removable disk drive (Restore).....	40

STEP13 Saving to and loading from DAT	41
1. Saving a song to a DAT recorder (Backup)	41
2. Loading a backed-up song from a DAT recorder (Restore)	42

Chapter 3 Reference..... 43

1. SONG/TRACK.....	44
2. EDIT SONG/TRACK.....	44
3. SYSTEM	47
4. EDIT SYSTEM	48
5. DISPLAY MODE	51
6. REC MODE.....	51
7. PLAY MODE.....	51
8. EDIT PLAY MODE.....	52
9. TRIGGER	52
10. EDIT TRIGGER.....	53
11. TEMPO.....	53
12. EDIT TEMPO	54
13. METRONOME.....	54
14. EDIT METRONOME.....	55
15. IN/LOC1, OUT/LOC2, TO/LOC3.....	55
16. SCENE.....	56
17. EDIT SCENE.....	56
18. STORE	57
19. SCRUB.....	57
20. UNDO	57
21. TRACK STATUS.....	58
22. EQ	58
23. EFFECT SEND	58
24. PAN/BALANCE.....	59
25. FADER	59
26. PAIR On/Off.....	60
27. REC SELECT	60
28. EFFECT	61
29. EDIT EFFECT	63
30. EFFECT ASSIGN	64
31. EDIT EFFECT ASSIGN.....	64

Chapter 4 Appendices..... 65

1. Troubleshooting.....	65
2. Various messages	67
3. MIDI Implementation Chart.....	68
4. Block Diagram.....	69
5. Effect Program List.....	71
6. Effect Parameter List	72
7. Metronm Type List.....	75
8. Demo Song List.....	75
9. D8 Specifications.....	76

Functions added to the D8..... 77

Bouncing tracks 1-8.....	77
--------------------------	----

Chapter 2 Operation

This chapter explains the operation of each of the D8's functions, in logical order.

STEP 1

Connections, Power-on, Demo

Here's how to connect the D8 to your audio system, and listen to the demo songs.

1. Connections to your audio system etc.

The following diagram shows a basic example of a D8 recording system. Modify the connections shown below as needed for your particular setup, and connect your equipment to the D8.

⚠ Be sure to turn off the power before making connections. Failure to do so can damage your speaker system or cause malfunctions.

- 1 Connect the included AC/AC power supply to the power supply connector of the D8. Then plug the power supply into an AC outlet.
- 2 Connect your audio equipment. Use an RCA phono cable to connect the OUTPUT L/R jacks to your amplification system.
- 3 If you wish to use headphones for monitoring, connect the phone plug of your headphones to the PHONES jack. The volume can be adjusted by the [PHONES] knob located at the left.
- 4 For analog recording, connect the phone plug of your guitar or mic cable to the INPUT 1 jack. (Refer to p.11) If you will be doing analog recording in stereo, connect the cables from the output of your

stereo device to the INPUT 1 and INPUT 2 jacks.

- 5 For digital recording, use an optical cable to connect the DIGITAL OUT of your instrument, CD, MD or DAT player to the DIGITAL IN connector. (Refer to p.12)
- 6 For mixdown to a digital recording device (DAT, MD etc.), use an optical cable to connect the DIGITAL IN of your recording device to the DIGITAL OUT of the D8. (Refer to p.30)
- 7 If you wish to use an external effect via AUX IN/OUT, connect the input of the effect to the AUX OUT jack, and the outputs of the effect to the AUX IN jacks. (Refer to p.23)
- 8 If you wish to use a foot switch to perform auto punch in/out, to start/stop playback, or to record tap tempo, connect a pedal switch PS1 <sold separately> to the FOOT SW jack. (Refer to p.47)
- 9 If you wish to synchronize a MIDI sequencer etc. to the D8, use a MIDI cable to connect the MIDI OUT of the D8 to the MIDI IN of your sequencer. If you will be using MMC, connect the MIDI OUT of your MIDI sequencer to the MIDI IN jack of the D8. (Refer to p.38)

2. Power on/off

⚠ When the power is turned on, never move the device or allow it to be jarred. Also, never turn off the power while the HDD access indicator is blinking (immediately after the power is turned on, during recording or playback, or during track/song editing). This can damage part or all of the data on

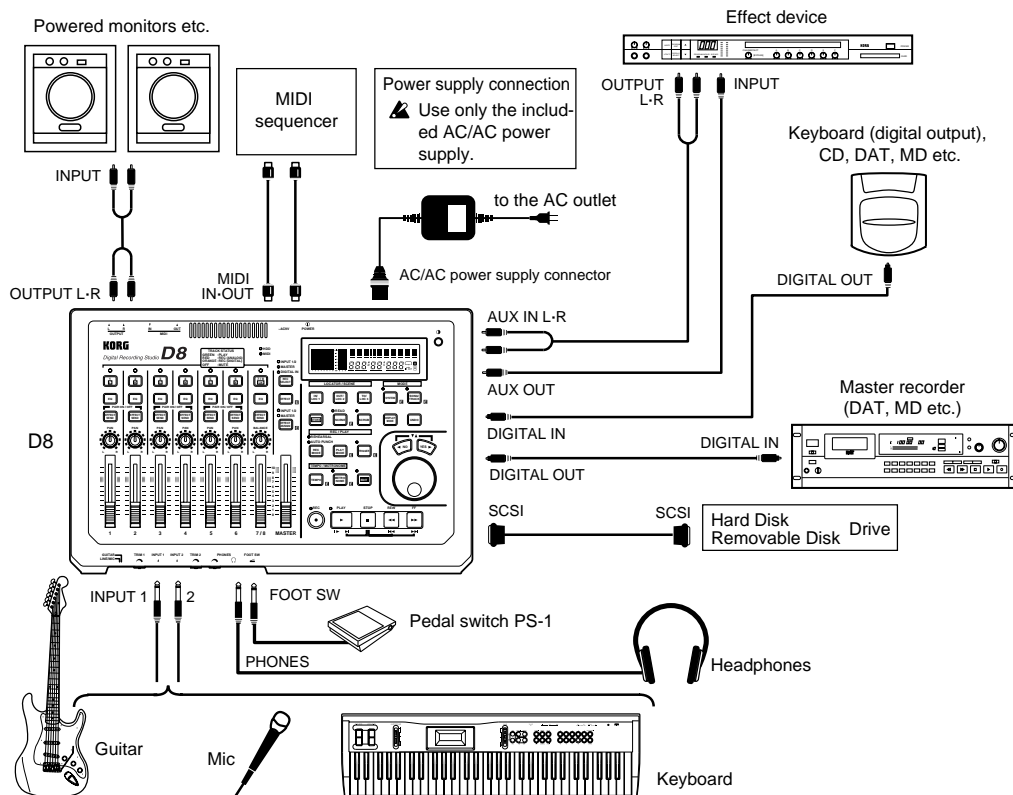

A guitar or bass can be directly connected only to INPUT 1.

If you will be recording only on one track, connect your instrument to INPUT 1. INPUT 2 is used only when simultaneously recording two tracks.

disk, or cause malfunctions such as damage to the hard disk or internal mechanism.

■ Turning the power on

- 1 Turn on the power of the connected devices. Set the volume of all devices to the minimum position, and turn on the power switches starting with the first device in the signal chain. If external drives are connected, refer to p.40.

- 2 Turn down the D8's master fader. Set the volume controls of all connected devices to the minimum position.

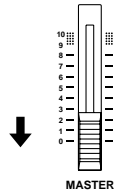

- 3 Turn on the power of your input devices and master recorder (DAT etc.).
- 4 Press the [POWER] switch of the D8 to turn on the power.

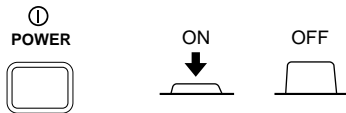

The display will show an opening message for a brief time, and then the song which was last selected when the power was turned off will appear.

- 5 Turn on the power of your powered monitor speakers, and raise the volume of the connected equipment to an appropriate level.

■ Turning the power off

Before turning the power off, make sure that all song recording or playback has been completed.

The audio that you record to the D8 will be saved automatically. However, if you edit effect settings or adjust the mixer, these settings will be lost unless they are saved. For the saving procedures, refer to p.13, for saving effect settings, and to p.29 for saving mixer settings (scenes).

- 1 Lower the volume of each connected device to the minimum position and turn the power off starting with the last device in the signal chain. If external drives are connected, refer to p.40.
- 2 If you wish to keep any edits you have made to the effects or to the mixer settings, store them.
- 3 Turn off the power of your amplification system.
- 4 Press the [POWER] switch to turn off the power of the D8.
- 5 Turn off the power of the audio input devices etc.

3. Listening to the demo songs

When shipped from the factory, the D8 contains pre-recorded demo songs. Playback to the demo songs to experience the dynamic and clear sound of the D8.

- 1 Move the D8's [CHANNEL] faders 1-7/8 to the unity gain position (the "||||" symbol in the fader calibrations), and set the [MASTER] fader to 0.

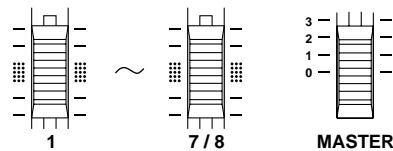

- 2 Select the song that you wish to playback.

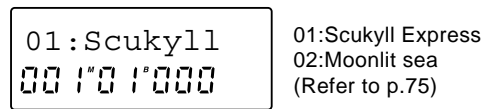

- ◇ To select the next song, hold down the [STOP] key and press the [FF] key. If there is no subsequent song, the display will indicate "NoDATA".
- ◇ To select the previous song, if you are at the beginning of the song ("001^M01^B000" etc.) hold down the [STOP] key and press the [REW] key. If you are located elsewhere than the beginning of the song, move to the beginning of that song. Then hold down the [STOP] key and press the [REW] key to move to the previous numbered song.

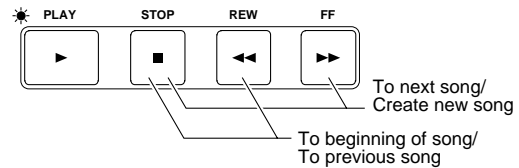

- 3 Make sure that the indicators above the [TRACK STATUS] keys of tracks 1-7/8 are lit green. If they are off or lit with a different color, press that [TRACK STATUS] key as many times as necessary to make each indicator light green.

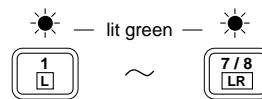

- 4 Press the [PLAY] key to begin playback.
- 5 Gradually move the [MASTER] fader upward to adjust the volume to an appropriate level.

As the song plays back, you can move the [CHANNEL] faders and [PAN] knobs, and adjust the EQ (refer to p.27, p.28) and effect send amount (refer to p.23), or change the effect program (refer to p.13) to see how the sound of the song is altered.

- 6 When the demo song finishes playing, press the [STOP] key to stop playback.

STEP2

Creating and selecting songs

To record a new song, you must first create a new song. This section explains how to create and name a song, and how to select songs in EDIT SONG/TRACK **P1**.

1. Creating a new song

- 1 After selecting the last-numbered song, hold down the [STOP] key and press the [FF] key. The display will indicate "NoDATA".

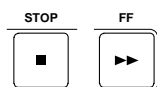
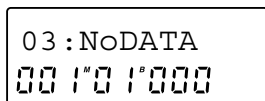

- 2 Use one of the following procedures to create a song.

- Change the song name from "NoDATA". In our example here, we will create a song by changing the song name. Refer to "2. Naming a song".
- Record audio data on a track. The display will indicate "NEWSONG" as the song name.
- Specify the tempo or time signature. A tempo map will be created in the tempo track, and the display will indicate "NEWSONG" as the song name.

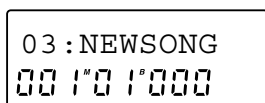

2. Naming a song

In order to distinguish your new song from other songs, it is recommended that you give it a name.

- 1 Press the [EDIT] key (the indicator will light), and then press the [SONG/TRACK] key to access the "Edit Song" display. If this display does not appear, press the [SONG/TRACK] key until the "Edit Song" appears.

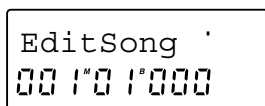

- 2 Press the [▶] key, and then press the [SONG/TRACK] key several times to get the "Renam" display.

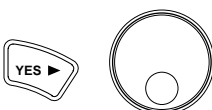
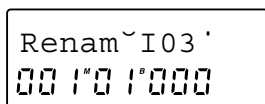

- 3 Press the [▶] key several times to move the cursor to the location where you wish to change the name, and use the [VALUE] dial to input alphabetical characters or symbols to specified the desired name.

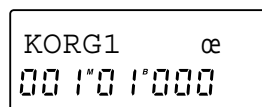

- 4 When you finish inputting the name, press the [EDIT] key (the indicator will go off) to exit the EDIT SONG/TRACK page. The name will be finalized when you exit this page.



Selecting another song

There are two ways to select songs. One way is to hold down the [STOP] key and press the [FF] key to select the next song number, or to hold down the [STOP] key and press the [REW] key to select the previous song number (refer to "Listening to the demo songs", step 2). The other way is to select the song in EDIT SONG/TRACK **P1**.

- 1 After pressing the [EDIT] key, press the [SONG/TRACK] key several times to get a song name display such as "I04:KORG1". (EDIT SONG/TRACK **P1**)

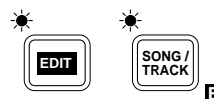
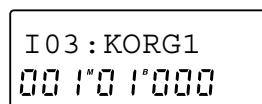

- 2 Rotate the [VALUE] dial to select the song number.
- 3 If you have connected an external drive such as a hard disk drive or removable disk drive and wish to select a song from it, press the [◀] key and then rotate the [VALUE] dial to select the connected drive.

STEP 3

Recording

This section explains the various methods of recording that are available on the D8. Use the recording method that is appropriate for your needs.

1. Recording (analog recording)

Normally you will record rhythm instruments such as drums first, and then listen to these instruments playback as you record bass, guitar and vocals.

As basic recording procedures, we will explain how to record a single track, and how to record two tracks simultaneously.

■ Connecting the input device and adjusting the level

- 1 Turn down the [MASTER] fader of the D8, and connect your instrument to the INPUT 1 jack. If you are recording a single track, you must use the INPUT 1 jack for connections. The INPUT 2 jack is active only when two tracks are being recorded simultaneously.

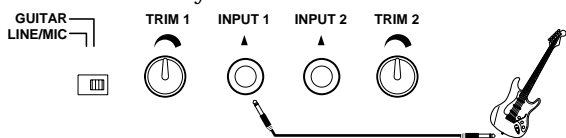

- ◇ If you wish to record two tracks simultaneously, make connections to the INPUT 1 and INPUT 2 jacks. If you are using an electric guitar or bass, connect it to the INPUT 1 jack (in preference to the INPUT 2 jack). If you are recording in stereo, connect the left channel output of the instrument to the INPUT 1 jack, and the right channel output to the INPUT 2 jack.

- 2 Use the [GUITAR-LINE/MIC] switch to select the appropriate input impedance for the instrument connected to INPUT 1 jack.

GUITAR: Select this position when inputting an instrument that has a high output impedance, such as guitar or bass.

MIC/LINE: Select this position when inputting a mic or a line instrument (keyboard, mixer etc.).

- ⚠ The [GUITAR-LINE/MIC] switch is only for the INPUT 1 jack. If you wish to connect a guitar/bass to the INPUT 2 jack, route it through a compact effect unit etc.

- 3 Press the [REC SELECT] key several times to select **INPUT 1/2** (indicator lit).

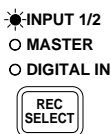

- 4 Press the channel 1 [TRACK STATUS] key several times to select **REC (ANALOG)** (indicator blinking red) to choose it as the recording track.



- ◇ If you are recording two tracks simultaneously, press the [TRACK STATUS] keys for two adjacent odd/even tracks (1-2, 3-4, 5-6, 7/8) to select **REC**

(**ANALOG**) (indicator lit red), to choose them as the recording tracks.

- 5 Set the [CHANNEL] fader to the unity gain position (the “█” symbol in the fader calibrations).

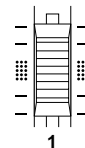

- 6 Raise the volume of the instrument connected to the INPUT 1 jack as high as possible, and while watching channel level 1 in the display, rotate the [TRIM 1] knob toward the right to adjust the recording level.

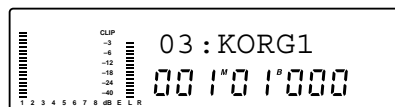

- ◇ If you are recording two tracks simultaneously, set the [CHANNEL] faders of both tracks you wish to record to the unity gain position, and use the [TRIM 1]/[TRIM 2] knobs to adjust the recording level.

- ⚠ Adjust the settings so that the input level is as high as possible without causing the “CLIP” indicator to light.

■ Starting and stopping recording

- 7 Record from the beginning of the track. Make sure that the location counter reads “001^M01^B000”. If a different time is selected, hold down the [STOP] key and press the [REW] key to return the current time to the beginning of the song.

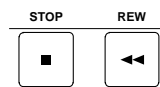

- 8 Press the [REC] key (the [REC] and [PLAY] indicators will blink) to enter record ready mode.



- 9 Press the [PLAY] key and recording will begin (the [REC] and [PLAY] indicators will light). Begin playing your instrument.

- 10 When you finish playing, press the [STOP] key to stop recording. (The [PLAY] and [REC] indicator will go off.)

■ Listening to the recorded performance (Playback)

Now let's listen to the performance that was recorded.

- 11 Hold down the [STOP] key and press the [REW] key to return to the beginning of the song.

- 12 Press the [TRACK STATUS] key for the track(s) that you recorded to select **PLAY** (indicator lit green), to select playback.



- 13 Press the [PLAY] key to begin playback (indicator is lit).

- When playback ends, press the [STOP] key to stop playback (the [PLAY] indicator is off).

2. Recording (digital recording)

Here's how to record digitally from an instrument which has a digital output or from an external digital device such as a CD or DAT player. Since the digital input of the D8 provides a sampling rate converter, 48 kHz and 32 kHz sources will be converted to 44.1 kHz as they are recorded.

As an example, we will record in stereo to tracks 3 and 4. When recording two tracks simultaneously, you will use an odd/even pair of adjacent tracks (1-2, 3-4, 5-6, 7/8).

- During digital recording, the effect will be off, and it will not be possible to use effects on any other track.

Connecting the input device and adjusting the level

- Turn down the [MASTER] fader or the D8, and connect the digital output of your keyboard, CD or DAT to the D8's DIGITAL IN connector.

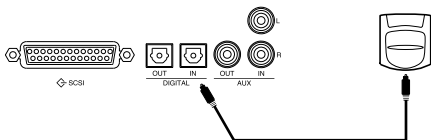

- Press the [REC SELECT] key to select **DIGITAL IN** (indicator lit).

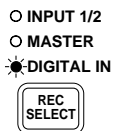

- Press the [TRACK STATUS] keys of channels 3 and 4 to select **REC (DIGITAL)** (indicator blinking orange), to choose tracks 3 and 4 for recording.

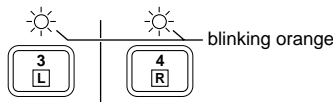

- Watch the channel level meters in the display, and raise or lower the [CHANNEL] faders of channels 3 and 4 to adjust the recording level of tracks 3 and 4.

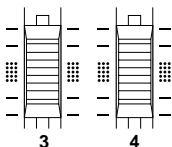

- Adjust the settings so that the input level is as high as possible without causing the "CLIP" indicator to light.

Starting and stopping recording

- Refer to "1. Recording (analog recording), Starting and stopping recording", and record your performance.

Listening to the recorded performance (Playback)

back)

- Refer to "1. Recording (analog recording), Listening to the recorded performance (Playback)", and listen to the playback.

3. Using EQ to modify the tone as you record

Here's how the built-in 2-band equalizer (EQ) can be applied to the input sound to modify the tone, so that the modified tone can be recorded.

Connecting the input device and adjusting the level

- Referring to the previous section "1. Analog recording" or "2. Digital recording", connect the device that you wish to record, and adjust the level.

- During analog recording, if the input level adjusted by [TRIM 1] and [TRIM 2] is inappropriate, the input sound may distort, or there may be unwanted noise. When the Channel Level Meter Select (refer to p.47) is set to **Post**, the channel level meters will indicate the volume level between the EQ and the [CHANNEL] faders. This means that if you apply EQ or set the faders to a position other than unity gain (or if you set the effect [EFFECT ASSIGN] to INPUT 1/2), it will not be possible to check just the input level.

- Press the [SYSTEM] key several times to make the display read "ChMtr", and rotate the [VALUE] dial to select **Pre**. Rotate the [TRIM 1] and [TRIM 2] knobs to adjust the input level as high as possible without causing the "CLIP" indicator of the channel level meters to light. After making adjustments, rotate the [VALUE] dial to return the "ChMtr" setting to **Post**.

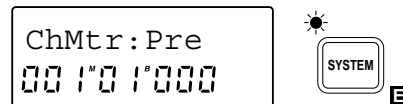

Adjusting the EQ

- Press the [EQ] key of the channel whose tone you wish to adjust, to make the display read "LEQ*" or "HEQ*" (* is the channel number). Then rotate the [VALUE] dial to adjust the EQ.

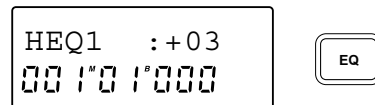

Starting and stopping recording

- Refer to "1. Recording (analog recording) Starting and stopping recording" to record.

Checking the recorded material (Playback)

- When you finish recording, refer to "1. Recording (analog recording) Listening to the recorded performance (Playback)" and playback your performance.

- If the Input Monitor (refer to p.47) is set to **AUTO**, the EQ and fader will affect only the input sound for tracks whose [TRACK STATUS] is set to **REC**, and will not affect the playback sound. By playing

back with the [TRACK STATUS] left at **REC**, you will be able to audition the sound just as it was actually recorded.
If you set the [TRACK STATUS] to **PLAY** and playback without changing the EQ settings the EQ will be applied double, so remember to set the EQ value back to 0.

4. Applying an effect to the input sound as you record

You can apply the internal effect of the D8 to the instrument connected to the INPUT 1/2 jack, and record the sound that has been processed by the effect.

■ Connecting the input device and adjusting the level

- 1 Refer to “■ Connecting the input device and adjusting the level” (p.11, p.12), to connect the input device and adjust the level.
- It is not possible to use the effect when recording digitally.

■ Selecting the location at which the effect will be inserted

- 2 Press the [EFFECT ASSIGN] key several times to select **INPUT 1/2** (indicator lit).



With a setting of **INPUT 1/2**, the internal effect will be inserted between the input and the EQ of the mixer channel whose [TRACK STATUS] is set to **REC**.

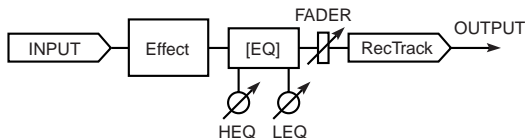

- 3 Adjust the following effect settings while listening to the input sound of the instrument or other source.
- Adjust the [TRIM] knob so that the effect (“E”) level meter does not light all the way to **CLIP**.

■ Selecting the effect program

- 4 Press the [EFFECT] key several times to access the display page for selecting an effect program, as shown below.



- 5 Rotate the [VALUE] dial to select an effect program.

■ Editing the effect

- 6 Each effect program consists of up to four effects.

(Refer to p.61) After pressing the [EDIT] key, press the [EFFECT] key several times to select the effect that you wish to edit.

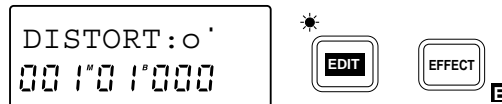

- 7 Rotate the [VALUE] dial to specify whether the effect you selected in step 6 will be used “o” (on) or not “-” (off).
- 8 Press the [▶] key to select the effect parameter that you wish to edit. Pressing the [▶] key will move to the next parameter, and pressing the [◀] key will move to the previous parameter. (Refer to p.72)

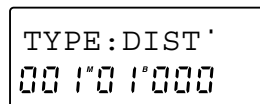

- 9 Rotate the [VALUE] dial to modify the value.

■ Saving the effect program

If you wish to use the edited effect program in this song, or to use it in more than one song as a general-purpose effect, you must save the effect program in the user bank.

- An edited effect which has not been saved will be lost if you perform one of the following actions.
- Select another effect program
 - Select another song
 - Turn off the power

- 10 Press the [EFFECT] key several times to make the display read “Ren→***” (* is the effect program name).

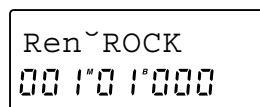

- 11 Press the [▶] key several times to move the cursor to the location where you wish to modify the name, and rotate the [VALUE] dial to enter alphabetical characters or symbols to assign the desired name.

~ is a special symbol. Once this display is modified, it cannot be selected newly.

- 12 Press the [EFFECT] key to access the “Write→U**” display. (U indicates the user bank area, and ** is the effect number.)

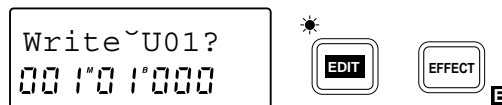

- 13 Rotate the [VALUE] dial to select the save destination in which the effect program will be saved.
- 14 Hold down the [▶] key for approximately one second to save the effect program and its name. When the data has been saved, the display will indicate “Completed”.

⚠ When you execute the Save operation, the effect program that previously occupied that memory will be overwritten and lost.

■ Starting and stopping recording

15 Press the [REC] key, and then press the [PLAY] key to begin recording. Press the [STOP] key to stop recording. (Refer to ■ “Starting and stopping recording”, p.11)

■ Listening to the recorded performance (Playback)

16 Move the current time to a location earlier than the point at which you began recording. Then set the [TRACK STATUS] of the recorded track to **PLAY**, and press the [PLAY] key to begin playback. Press the [STOP] key to stop playback. (Refer to “■ Listening to the recorded performance (Playback)”, p.11)

5. Applying an effect to the input sound and recording only the input sound

Here’s how you can apply the D8’s internal effect to the sound of an instrument or other sound source connected to the INPUT 1 jack or INPUT 2 jack. In this section, only the input sound is recorded. Use this method when you wish to try a variety of effects during playback and decide on the final sound later.

■ Connecting the input device and adjusting the level

1 Refer to “■ Connecting the input device and adjusting the level” (p.11, p.12), to connect the input device and adjust the level.

⚠ It is not possible to use the effect when recording digitally.

■ Selecting the location at which the effect will be inserted

2 Press the [EFFECT ASSIGN] key several times to select **MASTER** (Send Type) (indicator lit). With the setting **MASTER** (Send Type), the send bus will be output to the internal effect, which will be output to the master bus.

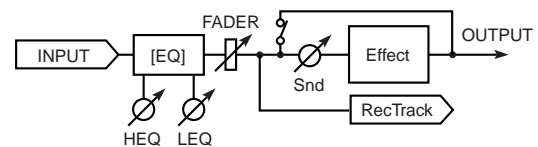
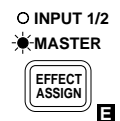

3 Adjust the following effect settings while listening to the input sound of the instrument or other source.

■ Sending the input sound to the effect

4 Press the [EFFECT SEND] key several times for the input channel where you wish to apply the effect,

to access the “Snd*” display (* is the channel number).

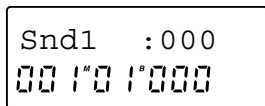

- 5 Rotate the [VALUE] dial to adjust the amount of the input sound that will be sent to the effect.

Be careful that the effect (“E”) level meter does not light all the way to **CLIP**.

■ Selecting the effect program

- 6 Select the effect program as explained in “4. Applying an effect to the input sound as you record, ■ Selecting the effect program”.

■ Adjusting the return level from the effect and the return balance

- 7 Press the [EDIT] key, and then press the [EFFECT ASSIGN] key several times to access the “EffRet” (effect return level) display.

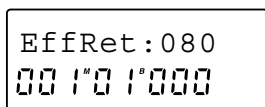

- 8 Rotate the [VALUE] dial to adjust the return level from the effect.

- 9 Press the [EFFECT ASSIGN] key to access the “EffBal” (effect return balance) display.

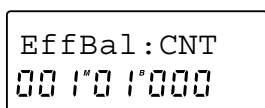

- 10 Rotate the [VALUE] dial to adjust the return balance from the effect.

■ Saving the effect program

- 11 Refer to “4. Applying an effect to the input sound as you record, ■ Editing the effect, ■ Saving the effect program”.

■ Starting and stopping recording

- 12 After pressing the [REC] key, press the [PLAY] key to begin recording, and press the [STOP] key to stop recording. (Refer to p.11, “■ Starting and stopping recording”)

■ Checking the recorded material (Playback)

- 13 Move the current time to a point earlier than where you began recording. Then set the [TRACK STATUS] to **PLAY** for the track that you recorded, press the [PLAY] key to playback, and press the [STOP] key to stop. (Refer to p.11, “■ Listening to the recorded performance (Playback)”)

6. Applying the dedicated delay to the input sound

In addition to the effect that was discussed in “4. Applying an effect to the input sound as you record” and “5. Applying an effect to the input sound and recording only the input sound”, the D8 provides a “monitor delay” that can be applied only to the input sound. When you are recording vocals or guitar, applying this delay will give the sound a sense of spaciousness. This delay will not be recorded. Since the monitor delay is not part of the internal effect, it lets you use the internal effect in other ways.

■ Connecting the input device and adjusting the level

- 1 Refer to “1. Recording (analog recording), ■ Connecting the input device and adjusting the level” to connect the input device and adjust the level.

It is not possible to use the effect or the monitor delay when recording digitally.

■ Turning the monitor delay on/off

- 2 Press the [EFFECT ASSIGN] key several times to select **INPUT 1/2** (indicator lit).



- 3 Press [EFFECT] several times to access the “MoniDly” display.

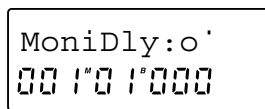

- 4 Rotate the [VALUE] dial to turn the monitor delay on (o).

When [EFFECT ASSIGN] is set to **INPUT 1/2** and [REC SELECT] is set to **INPUT 1/2**, turning the monitor delay on will only apply to tracks whose [TRACK STATUS] is **REC (ANALOG)**, and the monitor delay will apply to the sound that is input from the INPUT 1/2 jacks.

■ Editing the monitor delay

- 5 Press the [▶] key to select the monitor display parameter that you wish to edit. Press the [▶] key to move to the next parameter, or press the [◀] key to move to the previous parameter (refer to p.74).

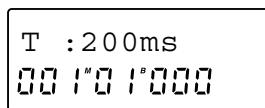

- 6 Rotate the [VALUE] dial to set the value.

7. Listening to recorded tracks while you record another track (Overdubbing)

The process of recording additional tracks while you listen to previously recorded tracks is called “overdubbing”.

As an example, we will explain how you can playback the sound that was recorded on track 1, and perform analog recording on track 2.

■ Select the playback/recording tracks

- 1 Press the track 1 [TRACK STATUS] key several times to select **PLAY** (indicator lit green), to enable (the previously recorded) track 1 for playback.

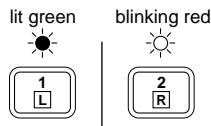

- 2 Press the track 2 [TRACK STATUS] key to select **REC (ANALOG)** (indicator blinking red), to enable it as the recording track.
- 3 Either turn down [CHANNEL] faders 3–7/8, or press their [TRACK STATUS] keys several times to select **MUTE** (indicator off), to mute these tracks so that they will not sound during playback.

■ Connecting the input device for the recording track and adjusting the level

- 4 As shown in “■ Connecting the input device and adjusting the level” (p.11, p.12), connect an instrument etc. to the INPUT 1 jack, and set the input level.
- 5 Raise or lower the [CHANNEL] fader of the playback track to a volume that will be comfortable for playing along with.

■ Starting and stopping recording

- 6 Press the [REC] key, and then press the [PLAY] key to begin recording. Press the [STOP] key to stop recording. (Refer to “■ Starting and stopping recording”, p.11)

■ Listening to the recorded performance (Playback)

- 7 Move the current time to a location earlier than the point at which you began recording. Then set the [TRACK STATUS] of the recorded track to **PLAY**, and press the [PLAY] key to begin playback. Press the [STOP] key to stop playback. (Refer to “■ Listening to the recorded performance (Playback)”, p.11)

8. Manually re-recording part of the performance (Manual Punch In/Out)

If you made a mistake during the performance that you recorded, or if you were not able to play the entire song as you had intended, there is no need to re-record the entire song — you can re-record just the part that you need.

“Punch In” is the action of switching from song playback to record, and “Punch Out” is the action of switching back from recording to playback.

“Manual Punch In/Out” is when you perform the Punch In and Punch Out manually. On the D8, you can Punch In during playback either by pressing the [REC] key or by pressing a foot switch <sold separately>. You can Punch Out by pressing either the [REC] key or the [PLAY] key, or by pressing a foot switch.

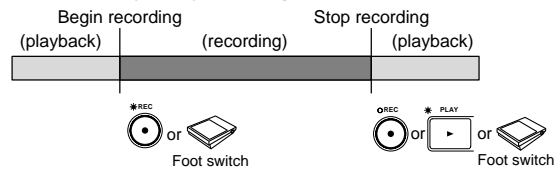

■ Connecting the input device and adjusting the level

- 1 As explained in “■ Connecting the input device and adjusting the level” (p.12), connect the input device and adjust the level. At this time, make adjustments so that there is no difference between the volume of the instrument that is being input and the volume of the track.

■ Select the input monitor

- 2 Press the [SYSTEM] key several times (indicator lit) to access the “Mon” display. Then rotate the [VALUE] dial to select **Auto**.



■ Starting and stopping recording

- 3 Move the current time location to a point earlier than the location that you wish to re-record. If you hold down the [STOP] key and press the [REW] key, you will move to the beginning of the song.
- 4 Press the [PLAY] key (indicator lit) to begin playback. The [TRACK STATUS] indicator which was set to **REC** will blink, and you will hear the sound of the track.

For tracks whose [TRACK STATUS] is set to **REC**, the EQ and fader will affect only the input sound, and will not affect the playback sound. After adjusting the input level, do not modify the fader or EQ settings during playback, since this will change the volume and EQ of the input sound.

- 5 When you wish to begin re-recording, press the [REC] key (Manual Punch In). The [TRACK STATUS] indicator will

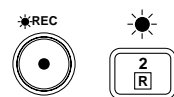

change from blinking to lit, and the D8 will enter record mode. Now you will hear the external input sound. Begin playing, and your playing will be recorded.

- 6 When you wish to stop recording, you can either press the [REC] key once again or press the [PLAY] key to change from recording back to playback. (Manual Punch Out)
The [TRACK STATUS] indicator will blink, the [REC] indicator will go off, and you will hear the track sound once again.
- 7 Press the [STOP] key (the [PLAY] indicator will go off) to stop song playback.

■ Listening to the recorded performance (Playback)

- 8 Move the current time location to a point earlier than where you began re-recording. Then set the [TRACK STATUS] of the recorded track to **PLAY**, and press the [PLAY] key to begin playback. Press the [STOP] key to stop. (Refer to “■ Listening to the recorded performance (Playback)”, p.11)
Also, playing back with [TRACK STATUS] set to **REC** will allow you to hear the sound just as it was recorded, without passing through the fader or EQ.

■ Using a foot switch for Manual Punch In/Out

By pressing a foot switch (sold separately), you can switch between playback and recording while you play an instrument, or from a remote location. This method can also be used when you wish to begin recording immediately from the precise beginning of the song.

- ◇ Connect your foot switch to the FOOT SW jack. Press the [SYSTEM] key several times (indicator lit) to access the “Fsw” display. Then rotate the [VALUE] dial to select **PncI/O**. Now you will be able to press the foot switch instead of pressing the [REC] key in steps 5 and 6 of the above procedure.

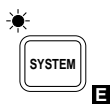
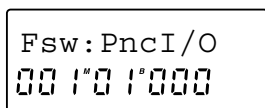

- ◇ If you wish to start recording from the very beginning of the song, press the [REC] key at the beginning of the song (the indicator will blink), and press the foot switch to start recording.

Canceling a recording or editing operation (Undo/Redo)

After you have recorded, or performed an editing operation such as track copy or delete (discussed later in this manual), you have the option of restoring the data to its original state. After you have recorded, performed a track editing operation, or used the Redo function, a “**U**” symbol will appear in the right of the display. When this is displayed, you have the option of using the Undo function to restore the data to its previous state. After the Undo function has been used, a “**R**” symbol will appear and you can use the Redo function to recover the state prior to using Undo.



■ Undo

- ◇ After recording or track editing, or after the Redo function has been used, the display will show a “**U**” symbol. Press the [UNDO] key to execute Undo, and the data will return to its previous state.

■ Redo

- ◇ After executing the Undo function, the display will show a “**R**” symbol. Press the [UNDO] key to execute Redo, and the data will return to the state prior to using Undo.

9. Automatically re-recording part of the performance (Auto Punch In/Out)

“Auto Punch In/Out” is a function which automatically performs Punch In and Punch Out at previously-specified time locations in the song. This allows you to accurately re-record a specific portion of a recording. Auto Punch In/Out is convenient when you wish to concentrate on your playing.

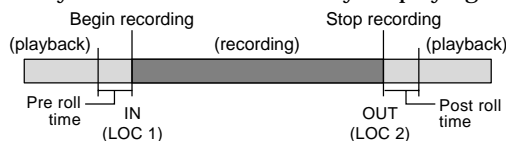

■ Storing the IN and OUT times

Storing the location at which recording will begin as the IN (punch in) time, and the location at which recording will end as the OUT (punch out) time.

- 1 Move the current time location to the point where you wish to begin recording. (Refer to “1. Moving the current time”, p.24)
- 2 Press the [STORE] key to prepare for storing the location. The display will indicate “Store”.

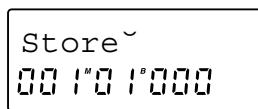

- 3 Press the [IN/LOC 1] key. The display will indicate “Store→In (destination)”, and the IN (punch in) time will be stored. Release the key, and you will return to the previous page.

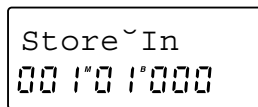

- 4 As described in steps 1–3 above, move the current time location to the point where you wish to stop recording, press the [STORE] key, and then press the [OUT/LOC 2] key to store the time location in OUT (punch out).

- ◇ You can also store the IN (punch in) and OUT (punch out) points while the song plays back. Press the [STORE] key, and then press the [IN/LOC 1] key at the time where you want to begin recording. In the same way, press the [STORE] key and then press the [OUT/LOC 2] key at the time where you want to stop recording.

■ Connecting the input device and adjusting the level

- As explained in “■ Connecting the input device and adjusting the level” (p.11, p.12), connect the input device and adjust the level. At this time, make adjustments so that there is no difference between the volume of the instrument that is being input and the volume of the track.

■ Select the input monitor

- Press the [SYSTEM] key several times (indicator lit) to access the “Mon” display (refer to SYSTEM P3). Then rotate the [VALUE] dial to select **Auto**.



■ Auto Play function and Auto Repeat function

When performing Auto Punch In/Out, it is convenient to use the Auto Play function or the Auto Repeat function in conjunction with Auto Punch In/Out (refer to p.51, p.52).

When the Auto Play function is on, pressing the [REC] key and then pressing the [PLAY] key will automatically move to the pre-roll time and begin playback. Then the IN-OUT area will be recorded, and the post-roll time will playback, and finally playback will stop automatically. In addition, if Auto Repeat is on, the Auto Play function will occur as described above, and then you will move to the pre-roll time without stopping and continue playing back to the post-roll time.

- Pressing the [PLAY MODE] key once will make the display show “^{IN}OUT”, and the Auto Play function will be turned on. Pressing the [PLAY MODE] key once again will make the display show “_{IN}OUT”, and the Auto Repeat function will be on.
- Press the [EDIT] key, then press the [PLAY MODE] key several times to make the display read “Pre-Rol”, and specify the pre-roll time. Rotate the [VALUE] dial to specify the value. Press the [▶] key and rotate the [VALUE] dial to set the unit to either measures (M) or seconds (s).

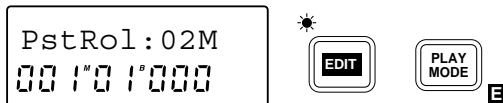

- Press the [PLAY MODE] key to make the display read “PstRol”, and referring to step 8, set the post-roll time. After making the setting, press the [EDIT] key.
- * Subsequent steps 10-18 are for when the Auto Play function is on. If you are not using the Auto Play/Repeat functions together, set the current time to a location earlier than the IN time, and then begin recording or playback.

■ Rehearsing auto punch in/out

Before you actually perform auto punch in/out recording, it is a good idea to rehearse the recording. If you do not need to rehearse, proceed to “■ Auto punch in/out setting”.

- Press the [REC MODE] key several times to select **AUTO PUNCH** + **REHEARSAL** (both indicators lit). When **AUTO PUNCH** + **REHEARSAL** is selected, initiating recording will cause the input monitor etc. to function in the same way as if recording were actually being performed. This allows you to rehearse the recording.

- Press the [REC] key ([REC] and [PLAY] indicator will blink), and then press the [PLAY] key ([REC] and [PLAY] indicator lit) to begin playback. The [TRACK STATUS] indicator that was set to **REC** will blink, and the track playback sound will be heard.

⚠ For tracks whose [TRACK STATUS] is **REC**, the EQ and fader will affect only the input sound, and will not affect the playback sound. After adjusting the input level, do not modify the fader or EQ settings during playback, since this will change the volume and EQ of the input sound.

- When the **IN** time location is reached, the [TRACK STATUS] indicator will change from blinking to lit, the [REC] indicator will begin blinking, and the external input sound will be heard. Begin rehearsing your performance.
- When the **OUT** time location is reached, the [TRACK STATUS] indicator will blink, the [REC] indicator will go dark, and the track playback sound will again be heard. Stop rehearsing your performance.

■ Auto punch in/out setting

- Press the [REC MODE] key several times to select **AUTO PUNCH** (indicator lit).

■ Starting and stopping recording

- Press the [REC] key ([REC] and [PLAY] indicator will blink), and then press the [PLAY] key ([REC] and [PLAY] indicator lit) to begin playback. The [TRACK STATUS] indicator that was set to **REC** will blink, and the track playback sound will be heard.
- When the **IN** time location is reached, the [TRACK STATUS] indicator will change from blinking to lit, and recording will begin. At this time the external input sound will be heard. Play to record your performance.
- When the **OUT** time location is reached, the [TRACK STATUS] indicator will change back to blinking, the [REC] indicator will go off, and recording will end. The track playback sound will once again be heard.

■ Listening to the recorded performance (Playback)

- Move the current time location to a point earlier than where you began re-recording. Then set the [TRACK STATUS] of the recorded track to **PLAY**, and press the [PLAY] key to begin playback. Press the [STOP] key to stop. (Refer to “■ Listening to the recorded performance (Playback)”, p.11) Also, playing back with [TRACK STATUS] set to **REC** will allow you to hear the sound just as it was

recorded, without passing through the fader or EQ.

and 8, rotate the [PAN] knobs of tracks 1–5 to place each track at the desired stereo location.

10. Combining multiple tracks into one or two tracks (Bounce)

The performance of multiple tracks can be combined into one or two tracks, freeing the original tracks for additional recording. This operation is called “track bouncing” or “ping pong recording”. This can be used when you wish to record more than 8 tracks, etc.

As an example, we will show how you can combine the performances of tracks 1–5 to track 6. We will also explain how you can combine tracks 1–5 to tracks 7 and 8 in stereo.

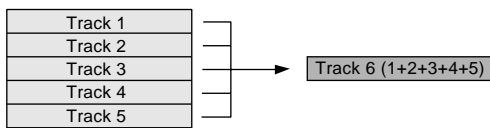

■ Playback track and recording track settings

- 1 Press the [REC SELECT] key several times to select **INPUT 1/2 + MASTER** (both indicators lit). With a setting of **INPUT 1/2 + MASTER**, you can use the master bus as the input for recording.

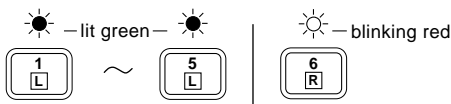
- 2 Press the [TRACK STATUS] keys for tracks 1–5 several times to set each one to **PLAY** (indicator lit green), to select these as playback tracks. Press the track 6 [TRACK STATUS] key several times to select **REC (ANALOG)** (indicator blinking red), to select it as the recording track.

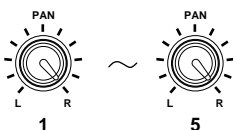

- ◇ If you are combining the other tracks to tracks 7 and 8 in stereo, press the track 7/8 [TRACK STATUS] key several times to select REC (ANALOG) (indicator blinking red).
- 3 Track 6 (the recording track) uses the “R” bus (printed on the [TRACK STATUS] key). Rotate the [PAN] knobs of tracks 1–5 to the far right position (R), so that their sound will be sent to the right channel.
-  When bouncing to a single track, be sure to set the [PAN] knobs of the bounce source tracks to match the indication of either “L” or “R” shown above the [TRACK STATUS] key of the bounce destination track.



- ◇ If you are combining tracks 1–5 in stereo to tracks 7

■ Adjusting the playback level and recording level

- 4 Press the [PLAY] key to begin playback.
- 5 Raise [CHANNEL] faders 1–5 to adjust the playback level of each track. (Refer to p.27)
- 6 Raise the [MASTER] fader to adjust the recording level to track 6.
The master level meter R will show the recording level to track 6.
 - ◇ If you are combining the tracks in stereo to tracks 7 and 8, the [MASTER] fader will adjust the recording level of tracks 7/8, and the master level meters L/R will show the recording level.
- 7 Since [CHANNEL] fader 6 will adjust the input level to INPUT 1, you can record an additional input sound while you bounce the other tracks. In this case, raise [CHANNEL] fader 6 to adjust the input sound. If you are not recording an input sound, either lower the fader.
 - ◇ If you are combining the tracks in stereo to tracks 7 and 8, [CHANNEL] fader 7/8 will adjust the input level.
- 8 For tracks 7/8 (which are not being recorded), either turn down [CHANNEL] fader 7/8 or press the [TRACK STATUS] key several times to select **MUTE** (indicator off).
 - ◇ If you are combining the tracks in stereo to tracks 7 and 8, track 6 will not be recorded. Either turn down [CHANNEL] fader 6 or select **MUTE**.

■ Applying EQ and effects while you record

- 9 Apply EQ to tracks 1–5 as desired while you record. (Refer to p.28)
 - 10 As desired, apply effects to tracks 1–5 and record them. For details on applying effects refer to “3. Applying effects to the playback sound” (p.21) or “2. Applying the internal effect during mixdown” (p.28)
-  When [EFFECT ASSIGN] is set to **MASTER (Send Type)**, the signal sent to the effect will be monaural, so there will be cases in which a stereo effect cannot be obtained even if a stereo input type effect is selected.

■ Starting and stopping recording

- 11 Press the [REC] key, and then press the [PLAY] key to begin recording. To stop recording, press the [STOP] key. (Refer to “■ Starting and stopping recording”, p.11)

■ Listening to the recorded performance (Playback)

- 12 Press the [TRACK STATUS] key to set tracks 1–5 to **MUTE** (indicator off), and set track 6 to **PLAY** (indicator lit green). Then raise [CHANNEL] fader 6 to adjust the playback level.
 - ◇ If you have combined tracks in stereo to tracks 7/8, set the [TRACK STATUS] of tracks 7/8 to **PLAY**, set all others to **MUTE**, and raise the [CHANNEL] fader 7/8 to adjust the playback level.
- 13 Move the current time location to a point earlier than where you began recording, and press the [PLAY] key to begin playback. Press the [STOP] key to stop playback. (Refer to “■ Listening to the recorded performance (Playback)”, p.11)

11. Listening to the metronome while you record

The D8 contains a wide variety of metronome patterns for each time signature. (Refer to “Metronome pattern list”) If you have an idea for a song, you can record immediately using the built-in metronome without having to connect a rhythm machine etc.

- ▲ The sound of the metronome will not be recorded. The metronome sound will be output together with the master audio output from the OUTPUT L-R jacks.

■ Turning the metronome on/off

- 1 Press the [METRONOME] key to turn the metronome ON (indicator lit). When you record or playback, the metronome will sound. (Refer to “Sounding the metronome during playback and recording”)



■ Adjusting the metronome volume

- 2 Press the [EDIT] key (the metronome will sound, and the indicator will light), and then press the [METRONOME] key to access the “MetVol” display. If the display reads “MetMod”, press the [METRONOME] key once again.

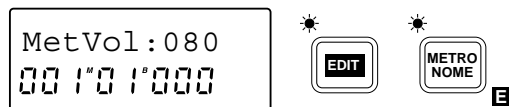

- ◇ Also, instead of pressing the [EDIT] key, you can press the [TEMPO] key several times to make the display read “MetVol” and adjust the metronome volume.

- 3 Rotate the [VALUE] dial to adjust an appropriate volume.

■ Sounding the metronome during playback and recording

- 4 Press the [METRONOME] key once again, to access the “MetMod” display.

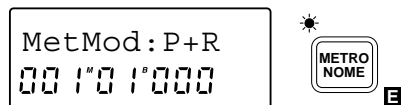

- 5 Rotate the [VALUE] dial to select **P+R** (Play+Recording). With this setting, the metronome will sound during playback and during recording. With a setting of **Rec**, the metronome will sound only during recording.

■ Setting the tempo and time signature

- 6 Press the [TEMPO] key (press the [EDIT] key to make the indicator go off) to access the display such as “0:120 | 4/4” which shows the tempo and time signature. (The metronome will sound.)

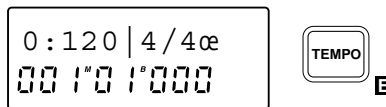

- 7 Rotate the [VALUE] dial to select **0** at the left edge. **0** is the basic tempo that is located at the beginning of the song.
- 8 Press the [▶] key to move the cursor to the tempo value, and rotate the [VALUE] dial to set the tempo. In the same way, press the [▶] key to move the cursor to the time signature, and rotate the [VALUE] dial to set the time signature.
 - ◇ You can press the [METRONOME] key to turn the metronome sound on/off.

■ Selecting the metronome pattern

- 9 Press the [▶] key, and then rotate the [VALUE] dial to select the metronome pattern. (Refer to “Metronome pattern list”)

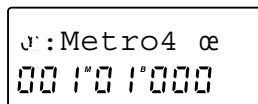

- ◇ You can change the time signature, tempo or metronome pattern during the song. (Refer to “Tempo map settings”, p.36)

■ Connecting the input device and adjusting the level

- 10 As explained in “Connecting the input device and adjusting the level” (p.11, p.12), connect the input device and adjust the level.

■ Starting and stopping recording

- 11 Press the [REC] key and a count will begin. Press the [PLAY] key to begin recording, and the selected metronome sound will be heard. Play along with the metronome sound. (Refer to “Starting and stopping recording”, p.11)

■ Listening to the recorded performance (Playback)

- 12 Move the current time location to a point earlier than where you began recording. Then set the [TRACK STATUS] of the recorded track to **PLAY**, and press the [PLAY] key to playback. Press the [STOP] key to stop. (Refer to “Listening to the recorded performance (Playback)”, p.11)

12. Trigger recording

You can use the input sound as a trigger that will start recording. The D8 will begin recording at the moment that sound is input.

■ Connecting the input device and adjusting the level

- 1 As explained in “■ Connecting the input device and adjusting the level” (p.11, p.12), specify the track to be recorded.

■ Preparations for trigger recording

- 2 Press the [TRIGGER] key to turn the Trigger function on (indicator lit).



- 3 Move to the time location where you wish to begin recording.
- 4 Press the [REC] key to enter record ready mode (indicator blinking).

■ Begin trigger recording

- 5 Begin playing. When the input exceeds the threshold level, recording will start.

⚠ If the Pre Trigger Time has been set to a value other than 000 mS, recording will begin at the specified time earlier than when triggering occurred, and any previously recorded sound during that interval will be erased (refer to p.53).

- 6 When you finish your performance, press the [STOP] key to stop recording.

■ Listening to the recorded performance (Playback)

- 7 Move the current time location to a point earlier than where you began recording. Then set the [TRACK STATUS] of the recorded track to **PLAY**, and press the [PLAY] key to playback. Press the [STOP] key to stop. (Refer to “■ Listening to the recorded performance (Playback)”, p.11)

■ Adjusting the threshold level

If the location where recording begins is not appropriate, you can change the settings of EDIT TRIGGER P1 (refer to p.53) to adjust the input level which will start recording.

STEP4

Playback

This section explains the variety of playback methods provided by the D8.

1. Playback

Here we will explain the basic method of playback. Refer also to the later section “Adjusting and registering mixer settings”.

■ Selecting the playback tracks

- 1 Press the [TRACK STATUS] keys for tracks which contain recorded material, to select **PLAY** (indicator lit green). 

■ Move the current time location to the beginning of the song

- 2 Hold down the [STOP] key and press the [REW] key. If you wish to move to another location in the song, refer to “Moving the current time”.

■ Starting and ending playback

- 3 Press the [PLAY] key to begin playback (indicator lit).
 - 4 Press the [STOP] key to stop playback (the [PLAY] indicator will go off).
- ◇ You can start/stop playback by pressing a foot switch <sold separately> (refer to p.47).

2. Playing a specified area of a song once or repeatedly

By using the “Auto Play function” which plays the IN-OUT area of the song once, or the “Auto Repeat function” which repeatedly plays back the IN-OUT area, you can playback a specified area. It is convenient to use these functions in conjunction with Auto Punch In/Out recording.

- 1 Press the [TRACK STATUS] key several times for each track that you wish to playback, to select **PLAY** (indicator lit green).
- 2 Store the IN and OUT locations of the desired area for playback. (Refer to “Locate points (LOC1, LOC2, LOC3)”, p.25)
- 3 If you wish to playback the IN-OUT area once, press the [PLAY MODE] key several times to make the “IN-OUT” symbol appear in the display. 

If you wish to repeatedly playback the IN-OUT area, press the [PLAY MODE] key several times to make the “IN-OUT” symbol appear in the display.

- 4 When “IN-OUT” is displayed, pressing the [PLAY] key will cause the IN-OUT area to playback, and then stop automatically. When “IN-OUT” is displayed, pressing the [PLAY] key will cause the IN-OUT area to playback repeatedly. Playback will stop when you press the [STOP] key.

3. Applying an effect to the playback sound

■ Selecting the tracks for playback

- 1 Press the [TRACK STATUS] key to select **PLAY** (indicator lit green).

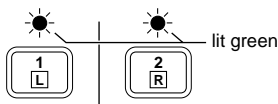

■ Specifying the location at which you wish to insert the effect

- 2 Press the [EFFECT ASSIGN] key several times to select **MASTER (Send Type)** (indicator lit). When **MASTER (Send Type)** is selected, the sound from the Send bus will be sent to the internal effect, and then output to the master bus.

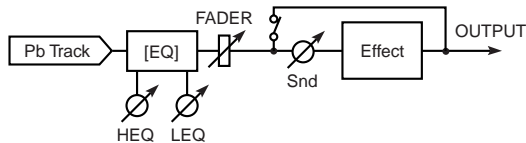

- 3 Press the [PLAY] key to begin playback.

■ Sending the playback sound to the effect

- 4 Press the [EFFECT SEND] key several times for each track to which you wish to apply the effect to access the “Snd*” display (* is the channel number).

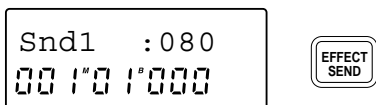

- 5 Rotate the [VALUE] dial to adjust the amount that will be sent to the effect.

- ⚠ Be careful not to make the effect (“E”) level meter light all the way to **CLIP**.

■ Selecting an effect program

■ Adjusting the return level and return balance from the effect

■ Editing an effect

■ Saving an effect program

- 6 As explained in “■ Selecting the effect program” – “■ Saving the effect program” (p.13, p.15), save the desired settings for the effect program.

- ⚠ When [EFFECT ASSIGN] is set to **MASTER (Send Type)**, the signal sent to the effect will be monoaural, so there will be cases in which a stereo effect cannot be obtained even if a stereo input type effect is selected.

4. Applying an external effect to the playback sound

- 1 Connect the INPUT jack of an external effect device to the D8's AUX OUT jack, and the OUTPUT jacks of the external effect device to the D8's AUX IN jacks. If the external effect has stereo output, connect its OUT L/R jacks to the D8's AUX IN L/R jacks.

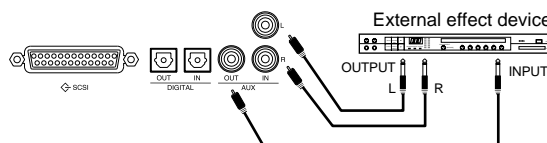

- 2 Press the [EFFECT ASSIGN] key several times to select **MASTER (Send Type)** (indicator lit).

- ⚠ When **INPUT 1/2** or **MASTER (Global Type)** is selected, the input from the AUX IN jacks is ignored.

- 3 Press the [PLAY] key to begin playback.

■ Sending the playback sound to the external effect

- 4 Press the [EFFECT SEND] key several times for each playback track where you wish to apply the external effect, to access the “Aux*” display (* is the channel number).

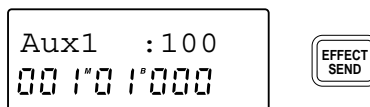

- 5 Rotate the [VALUE] dial to adjust the amount that will be sent to the external effect.

- ⚠ Be careful that the input of the external effect does not clip.

■ Adjusting the input level and input balance from the external effect

- 6 Press the [EDIT] key, and then press the [EFFECT ASSIGN] key several times to access the “AuxRet” display (external input level).

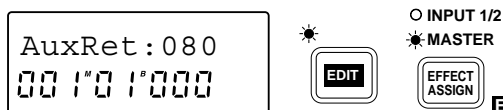

- 7 Rotate the [VALUE] dial to adjust the return level from the external effect.

- 8 Press the [EFFECT ASSIGN] key to access the “AuxBal” display (external input balance).

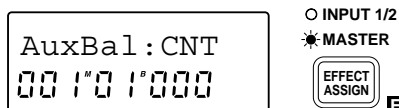

- 9 Rotate the [VALUE] dial to adjust the return balance from the effect.

5. Program playback of songs

You can enable two or more songs to playback in a specified order. This can be used to playback a medley of songs, or when you wish to record consecutive mixdowns of songs to DAT or MD. Program Play can be performed even across multiple drives. As an example, we will explain how to playback songs in the order of song number I (internal drive) **01**→**I02**→**A** (SCSI ID 0) **05**.

- 1 Press the [EDIT] key, and then press the [PLAY MODE] key several times to access the "P**" display (** is the sequence of playback).

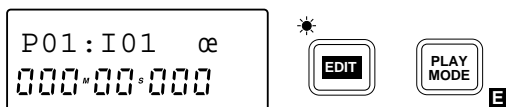

- 2 Rotate the [VALUE] dial to select the first step in the playback sequence; **P01**.
- 3 Press the [▶] key, and then rotate the [VALUE] dial to select the drive from which the song will be played back. In this example, select the internal drive **I**.
- 4 Press the [▶] key, and then rotate the [VALUE] dial to select the song which will be played back as the first song. In this example, select **01**.
- 5 Press and hold the [▶] key for approximately 1 second to finalize the first song for playback. When this is finalized, the "?" will disappear.
- 6 Rotate the [VALUE] dial to select the second song for playback. Referring to steps 3-5, set **P02** to song **I02**, and set **P03** to song **A05**.
- 7 Press the [PLAY] key, and the songs will playback in the specified sequence, starting with **I01**.

⚠ Program playback is available only when you are in this page. Also, the specified sequence of songs will be canceled when you leave this page.

6. Switching scenes during playback

A set of mixer settings that have been stored is called a "scene", and scenes can be switched as time elapses during playback. (Refer to p.29)

STEP 5

Moving and storing time locations

This section explains how to move between time locations in a song. It also explains how you can store a specific time location for instant recall.

1. Moving the current time

■ Using the location counter to move

- 1 Simultaneously press the [◀] and [▶] keys to move the cursor below the location counter.

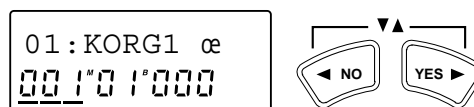

- 2 Use the [◀] or [▶] keys to move the cursor to the unit of time that you wish to change (measure^M, beat^B, 1/96th beat, Mark etc.)*. For details on Marks, refer to p.26.
- 3 Rotate the dial to move the time location. Rotating the dial toward the right will increase the time, and rotating it toward the left will decrease the time.

* You can change the units of time that appear in the display. Four methods of display can be selected. (Refer to "5. DISPLAY MODE", p.51)

■ Using the [STOP], [REW] and [FF] keys to move

Moving backward

- ◇ Press the [REW] key to move toward the beginning of the song. If you hold down the key, you will move continuously. You can also move during playback.

Moving forward

- ◇ Press the [FF] key to move toward the end of the song. If you hold down the key, you will move continuously. You can also move during playback.

Moving to the beginning of the song/Moving to the beginning of the previous song

- ◇ If the current time is in the middle of the song, you can hold down the [STOP] key and press the [REW] key to move to the beginning of the song.

If the current time is at the beginning of the song, you can hold down the [STOP] key and press the [REW] key to select the song of the previous number, and move to its beginning.

Moving to the beginning of the next song/Creating a new song

- ◇ If you hold down the [STOP] key and press the [FF] key, you will select the song of the following number, and move to its beginning. If the following number does not contain a song, a new song will be created for that number. (Refer to p.10)

2. Finding a precise time location

If you wish to find the exact time location at which a sound begins, or when setting locate points or storing marks, you can use the Scrub function or the Play From/Play To functions to find and select time locations more accurately.

■ The Scrub function

On the D8 you can perform Scrubbing just as on an open reel tape recorder. By rotating the [VALUE] dial you can playback the song to accurately find a desired moment in time. This is called the “Scrub” function.

- 1 Set the [TRACK STATUS] to **PLAY** (indicator lit green) for the track that you wish to scrub.
- 2 Press the [SCRUB] key to turn on the Scrub function (indicator lit). 
- 3 Rotate the [VALUE] dial to find the precise location while you listen to the sound. The track will playback linked with the movement of the [VALUE] dial.

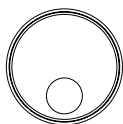

At this time, the level meter will show the pre-fader volume level of each track. When the dial is not moving, the volume level at that time will be displayed.

■ Play From/Play To/Slow Play functions

- 1 Set [TRACK STATUS] to **PLAY** (indicator lit green) for the track that you wish to scrub.
- 2 Press the [SCRUB] key to turn on the Scrub function (indicator lit).
- 3 Press the [PLAY] key, and playback will occur from the current time for two seconds, and will then stop. Then you will automatically return to the location at which playback began (Play From).

Hold down the [STOP] key and press the [PLAY] key, and the sound will playback from approximately two seconds before the current time, and will then stop (Play To).

Press the [FF] key, and the sound will playback from the current time at half-speed, and will stop and automatically return to the playback start location when you press the [STOP] key (Slow Play).

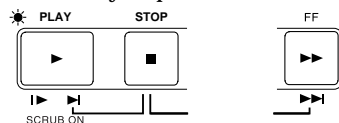

- ◇ It is convenient to use the Scrub function or Slow Play to find the precise time, and then to use the Play From/Play To functions to verify that time location.

3. Locate points (LOC1, LOC2, LOC3)

You can store a specific time location, and then move instantly to that location at any time. For each song, you can store three “Locate” points, and also one hundred “Mark” points. In addition to being used to move instantly to a desired time, Locate points are also used as the in/out times for Auto Punch In/Out recording, and to specify the in/out/to times for track editing operations. (Refer to p.31)

■ Storing a Locate point

Here’s how to use the Locate function to store the current time. A time that has been stored in this way is called a “Locate point”.

- 1 Move the current time to the location that you wish to store. (Refer to “1. Moving the current time”, p.24)
- 2 Press the [STORE] key to prepare to store the time. The display will indicate “Store”.

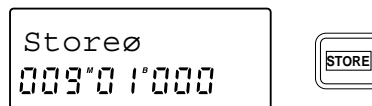

- 3 Press the key [IN/LOC 1], [OUT/LOC 2] or [TO/LOC 3] for which you wish to store the current time. The display will indicate “Store→*** (store destination In, Out, To)”, and the current time will be stored to the key. Release the key, and the previous page will reappear.



Storing during playback or recording

While you are playing or recording a song, you can use the above steps 2 and following to store a locate point. The time location at the moment that you press the [IN/LOC 1], [OUT/LOC 2] or [TO/LOC 3] key will be stored.

■ Moving to a Locate point

- ◇ When you press a [IN/LOC 1], [OUT/LOC 2] or [TO/LOC 3] key that you have previously stored, you will move to the stored time.



4. Mark points

You can store a desired time location and move instantly to that time. Up to one hundred Mark points can be stored in each song.

■ Storing a Mark point

Here's how to use the Mark function to store the current time. A time location that has been stored in this way is called a "Mark point".

- 1 Move the current time to the desired location.
- 2 Press the [STORE] key twice to prepare for storing. The display will indicate "Mark".

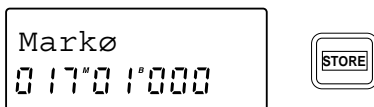

- 3 Press any one of the [IN/LOC 1], [OUT/LOC 2] or [TO/LOC 3] keys. The display will indicate "Mark→M***" (stored number), and the current time will be stored as a Mark point. Release the key, and the previous page will reappear.



Storing during playback or recording

During playback or recording, you can perform the above steps 2 and following to store a Mark point. The time location at the instant you press the [IN/LOC 1], [OUT/LOC 2] or [TO/LOC 3] key will be stored.

Storing using a foot switch

- 1 Press the [SYSTEM] key several times to access the "Fsw" display, and then rotate the [VALUE] dial to select **Mark**.
- 2 A Mark point will be stored at the instant you press the foot switch. You can store Mark points during playback or during recording.

■ Moving to a Mark point

- 1 Simultaneously press the [◀] and [▶] keys to move the cursor below the location counter.
- 2 Press the [▶] key several times so that the cursor is displayed below the entire location counter.

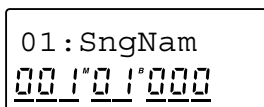

- 3 Rotate the [VALUE] dial to select the Mark points that have been stored, and move the current time.

■ Deleting a Mark point

- 1 Press the [EDIT] key, and then press the [SYSTEM] key several times to access the "Mark" display.

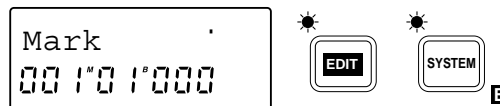

- 2 Press the [▶] key to access the "Del" display, and rotate the [VALUE] dial to select the Mark that you wish to delete. If you select **All**, all Mark points will be deleted.

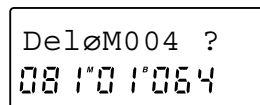

- 3 Press and hold the [▶] key for approximately one second to execute the operation. When the Mark has been deleted, the display will indicate "Completed". Press the [▶] key to restore the previous display.

STEP 6

Adjusting and storing mixer settings

This section explains how you can adjust the volume, tone and pan etc. of the input/recording/playback for each channel, to create the desired overall balance of sound. This process is known as “mixdown”. Mixer settings can also be registered as a “scene”. Scenes can be selected as time passes during playback, or recalled as general-purpose settings.

1. Pairing settings

You can group the settings of adjacent odd/even mixer channels (1-2, 3-4, 5-6), so that changes made to the values of one channel will be reflected by both channels. This is referred to as “pairing”. This is convenient when you are mixing tracks that were recorded in stereo.

Pairing applies to the settings of the [TRACK STATUS] keys, high EQ “HEQ”, low EQ “LEQ”, effect send “Snd”, Aux send “Aux”, the [PAN] knobs and the [CHANNEL] faders.

Of these, you can specify for each setting other than the [TRACK STATUS] keys and the [CHANNEL] faders whether or not the setting will be paired when pairing is turned on.

■ Pairing on/off

- 1 To turn pairing on, simultaneously press the [EFFECT SEND] keys for the desired pair of adjacent odd/even channels (1-2, 3-4, 5-6).



When pairing is on, parameters for which pairing is enabled can be operated as follows.

[TRACK STATUS] keys, “HEQ”, “LEQ”, “Snd” and “Aux” can be set from either odd or even channel.

[CHANNEL] faders and [PAN] knobs (pan will function as the left/right balance adjustment when paired) are operated from the odd-numbered channel (1, 3, 5). Adjustments made to the even-numbered channel will be ignored.

When pairing is on, adjusting the EQ etc. will cause the display to appear as follows.

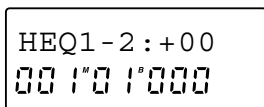

- 2 To turn pairing off, simultaneously press the [EFFECT SEND] keys of the adjacent odd/even channels.

■ Enabling parameters for pairing

For the [PAN] knobs, “Snd”, “Aux” and “EQ”, you can specify whether or not pairing will be enabled for each parameter. This setting is common to the entire song.

- 1 Press the [EDIT] key, and then press the [SYSTEM] key several times (the indicator will light) to access the “ChPairSw” display.

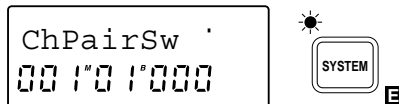

- 2 Press the [▶] key to move the cursor, and press the [SYSTEM] key to select the item for which you wish to enable/disable pairing.

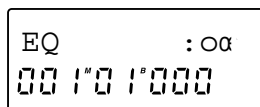

- 3 Rotate the [VALUE] dial to enable (o) or disable (-) pairing.

2. Adjusting the volume of each channel

You can adjust the input/recording/playback volume of each channel. The available range extends from OFF to unity gain (0dB)* and an additional +12 dB of gain. Normally you will leave the faders set at unity gain, and rather than raising the fader for low-volume channels, it is best to make adjustments by lowering the other faders.

* Unity gain refers to the state at which the audio signal does not change, and is the optimal level for the sound.

- ◇ To adjust the volume, raise or lower the [CHANNEL] fader of the corresponding channel. When pairing is on, use the odd-numbered channel to make adjustments.



This parameter can be stored in a scene.

- ▲ When the input monitor (refer to p.47) is set to **AUTO**, the faders of tracks whose [TRACK STATUS] is set to **REC** will affect only the input sound, and will not affect the playback sound (refer to p.58).

3. Adjusting the stereo location

You can adjust the stereo location of the sound of each channel. Normally, vocals and bass etc. are placed in the middle, guitar at either left or right, and piano at the opposite side from the guitar.

- ❖ Rotate the [PAN] knob or [BALANCE] knob to adjust the stereo location of each channel. Rotating the [PAN] knobs of channels 1-6 toward the left will move the sound to the left, and rotating them toward the right will move the sound to the right. The [BALANCE] knob of channels 7/8 adjusts the left/right balance. When pairing is on, the [PAN] knobs will adjust the left/right balance, and only the [PAN] knobs of the odd-numbered channels are used.

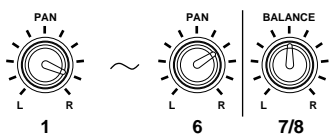

This parameter can be stored in a scene.

4. Using the EQ to adjust the tone

You can use the equalizer to adjust the tonal character of each channel. If you adjust the tone of the input signal as you record it, the sound will be recorded that way.

This can be used to cut the high frequency range which sometimes contains obtrusive hiss noise, or to cut/boost the low range or high range to adjust the tonality.

Normally, you will use EQ to give the sound more clarity and definition. However if EQ settings are excessively high, such as when the maximum amount of boost is used, the overall mix will be unbalanced, and the sound can be fatiguing. It is recommended that EQ be used in the “cut” direction as well, and that you use no more boost/cut than necessary.

■ Adjusting the High EQ

The high EQ lets you cut/boost the 10 kHz frequency range over a range of -15-+15 dB.

- 1 Press the [EQ] key of the channel whose tone you wish to adjust, to access the “HEQ*” display (* is the channel number). “HEQ” and “LEQ” will alternate each time you press the key.

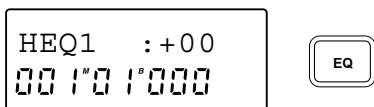

- 2 Rotate the [VALUE] dial to adjust the EQ gain.

■ Adjusting the Low EQ

The low EQ lets you cut/boost the 100 Hz frequency range over a range of -15-+15 dB.

- 1 Press the [EQ] key of the channel whose tone you wish to adjust, to access the “LEQ*” display (* is the channel number). “HEQ” and “LEQ” will alternate each time you press the key.

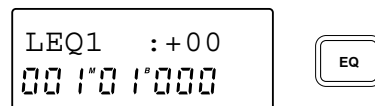

- 2 Rotate the [VALUE] dial to adjust the EQ gain.
- ⚠ When the input monitor (refer to p.47) is set to **AUTO**, the EQ of tracks whose [TRACK STATUS] is set to **REC** will affect only the input sound, and will not affect the playback sound (refer to p.58). Also, after recording with EQ applied, if you leave the EQ settings as they are and playback with [TRACK STATUS] set to **PLAY**, be aware that the EQ will be applied twice (refer to p.58).

5. Adjusting the Effect Send, AUX Send and Track Status

Effect Send (“Snd”) adjusts the amount of sound that is sent from each channel to the internal effect (refer to p.14 and p.23).

AUX Send (“Aux”) adjusts the amount of sound that is sent from each channel to AUX OUT. (Refer to p.23)

Track Status ([TRACK STATUS]) determines whether each track can be recorded or played back, or will be muted.

6. Scene

Mixer settings can be stored as a “scene”, and scenes can be recalled automatically as playback progresses, or recalled whenever desired as general-purpose mixer setups. Up to 20 scenes can be stored in each song.

■ Storing a scene

For each channel, the volume level specified by the [CHANNEL] fader, the stereo location set by the [PAN] knob or [BALANCE] knob, the high EQ “HEQ” and low EQ “LEQ” settings, the effect send level “Snd” and the AUX send level “Aux” can be stored in a scene.

- 1 Move the current time to the location where you wish to store the scene.
- 2 Adjust the mixer settings at that time location.
- 3 Press the [STORE] key to access the “Store” display.

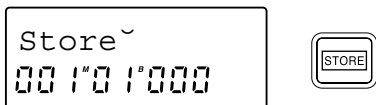

- 4 Press the [SCENE] key to access the “Store→S**” display (** is the scene number into which the settings will be stored), and the mixer settings will be stored as a scene.

Scene numbers will be assigned automatically, beginning from the lowest vacant number.

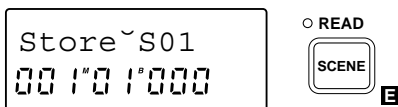

Storing a scene during playback or recording

During playback or recording, you can perform the above steps 3 and following to store a scene. In this case, the time location and mixer settings at the moment you press the [SCENE] key will be stored as the scene.

■ Switching scenes during a song

Scenes that have been stored can switch automatically as playback progresses.

- 1 Refer to “■ Storing a scene”, and register a scene at the desired times in the song.
- 2 Press the [SCENE] key to select Scene Read ON (indicator lit). This setting will alternate on/off each time the key is pressed.



- 3 Move to the location from which you wish to playback, and press the [PLAY] key to begin playback. (Refer to “1. Playback”, p.22)
When the stored time arrives, the scene will change automatically.

■ Recalling a scene

- 1 If the [SCENE] indicator is lit, press the [SCENE] key to turn Scene Read OFF (indicator off).



- 2 After pressing the [EDIT] key, press the [SCENE] key to access the “S**:Fader” display (** is the scene number).

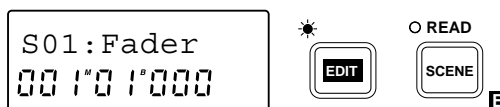

- 3 Rotate the [VALUE] dial to select the scene number. The selected scene will be recalled.

■ Deleting a scene

- 1 Press the [EDIT] key, and then press the [SCENE] key several times to access the “Del→S**” display (** is the scene number).

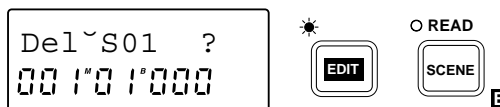

- 2 Rotate the [VALUE] dial to select the scene number (S01–S20) that you wish to delete. If you select All, all scenes will be deleted.
- 3 Press and hold the [▶] key for approximately one second to delete the scene. When the data has been deleted, the display will indicate “Completed”. Press the [▶] key to restore the display.

STEP 7

Mixdown

A song that you have completed by recording tracks and mixing can be recorded on an external two-channel recorder such as a cassette tape recorder, DAT recorder or MD recorder. This process is referred to as "mixdown".

1. Recording a master tape (Mixdown)

■ Listening to the completed song

- 1 Use the [CHANNEL] faders to adjust the volume level of each channel.
- 2 Use the [PAN] knobs and [BALANCE] knobs to adjust the stereo location of each track.
- 3 Press the [EQ] key for each track and use the [VALUE] dial to adjust the tone.
- 4 Adjust the effects. For effects which are particularly appropriate during mixdown, refer to "2. Applying the effect during mixdown".

■ Connect an external recording device and record

- 5 If you will be making an analog recording, use RCA phono cables to connect the analog LINE IN jacks of your cassette recorder, DAT recorder or MD recorder etc. to the OUTPUT L-R jacks of the D8.

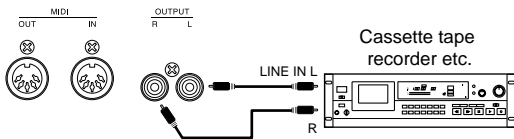

If you will be making a digital recording, use an optical cable to connect the DIGITAL IN connector of your DAT recorder or MD recorder to the DIGITAL OUT connector of the D8.

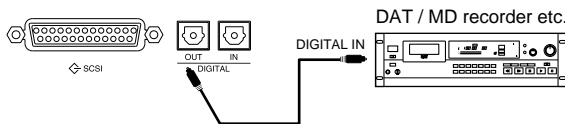

- 6 Playback the D8, and adjust the recording level on your cassette tape recorder, DAT recorder or MD recorder etc. Then return the D8 to the beginning of the song, and record the mixdown on your recorder.

2. Applying an effect during mixdown

During mixdown, you can apply effects such as limiter (an effect which smoothes out the volume of the input signal) or compressor (an effect which compresses the input signal to give the sound more consistency and punch) so the sound that is output and recorded on the external recorder will be consistent in volume.

■ Specifying the location at which the effect will be inserted

- 1 Press the [EFFECT ASSIGN] key several times to select **MASTER (Global Type)** (indicator blinking).

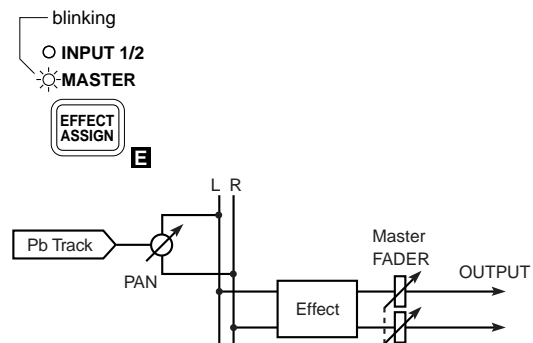

- 2 Playback the song while you adjust the effect settings described below.

■ Selecting an effect program

- 3 As described in "■ Selecting the effect program" (p.13), select an effect program such as "DY1: LIMIT" (TOTAL LIMITER)", etc.

■ Editing the effect

■ Saving the effect program

- 4 As described in "■ Editing the effect" - "■ Saving the effect program" (p.13), adjust the desired settings for the effect program.

STEP 8

Track editing

This section explains the editing operations (copy, insert blank, delete, exchange etc.) that can be performed on tracks.



1. Storing IN, OUT and TO times

In order to edit track data, you must store the time locations at which editing will be performed. As explained in "3. Locate points (LOC1, LOC2, LOC3)" (p.25), LOC1 functions as the IN time, LOC2 as the OUT time, and LOC3 as the TO time.

- 1 Change the current time location to the point that you wish to store as the IN time. (Refer to "1. Moving the current time", p.24)

The IN time will function as follows for each editing operation.

- Copy Track:** the beginning of the source data that will be copied
- Insert Track:** the location at which the blank will be inserted
- Erase Track:** the location at which erasure will begin
- Delete Track:** the location at which deletion will begin
- Swap Track:** the location at which the exchange will begin

- 2 Press the [STORE] key to access the "Store" display, and then press the [IN/LOC 1] key to store the IN time.
- 3 Change the current time location to the point that you wish to store as the OUT time.

The OUT time will function as follows for each editing operation.

- Copy Track:** the end of the source data that will be copied
- Insert Track:** the location at which the inserted blank will end
- Erase Track:** the location at which erasure will end
- Delete Track:** the location at which deletion will end
- Swap Track:** the location at which the exchange will end

- 4 Press the [STORE] key to access the "Store" display, and then press the [OUT/LOC 2] key to store the OUT time.
- 5 Change the current time location to the point that you wish to store as the TO time.

The TO time needs to be stored only if you are using the Copy Track operation, and will be the time at which the data will be placed in the copy destination track.

- 6 Press the [STORE] key to access the "Store" display, and press the [TO/LOC 3] key to store the TO time.



2. Copying track data (Track Copy)

This operation copies a portion (IN-OUT) of a recorded track to another location (TO). You can copy data from a single track or from multiple tracks simultaneously. You can also copy the data more than one time. By using the clipboard, you can copy data to another song.

For example, you could use this to repeatedly copy a phrase of several measures, such as a drum pattern, or record a favorite phrase in one track, and use it by copying it to other tracks or songs.

■ Copying the IN - OUT area of track 1 to the TO location of another track in the same song multiple times

As an example, we will explain how to copy the IN-OUT area of track 1 to the TO location of track 2 three times.

- 1 As described in "1. Storing IN, OUT and TO locations", store the IN, OUT and TO locations.
- 2 Press the [EDIT] key, and then press the [SONG/TRACK] key several times to access the "Edit-Track" display.

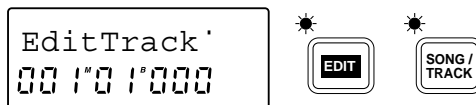

- 3 Press the [▶] key, and then press the [SONG/TRACK] key several times to access the "Cpy" display.

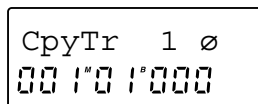

- 4 Rotate the [VALUE] dial to set the source track (the track from which the data will be copied) to 1.
- 5 Press the [▶] key, and then rotate the [VALUE] dial to set the destination track (the track to which the data will be copied) to 2.

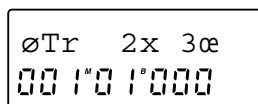

- 6 Press the [▶] key, and then rotate the [VALUE] dial to set the number of copies to 3.
- 7 Make sure that the correct settings have been made. If it is all right to execute the copy operation, press and hold the [▶] key for approximately one second. When the copy is completed, the display will indicate "Completed". Press the [▶] key to restore the previous display.

- 8 Move to the TO location, and playback to check that the copy was performed correctly. If the data was copied to the wrong location, press the [UNDO] key to return the data to the previous condition, and then perform the copy operation once again.

Example: Copying the IN-OUT area of track 1 to the TO location of track 2 three times in the same song

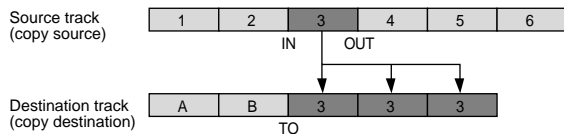

■ Copying the IN-OUT area of track 1 to the TO location of another song track once

As an example, we will explain how to copy the IN-OUT area of track 1 to the TO location of track 1 of song 2 once.

- 1 As described in “1. Storing IN, OUT and TO locations”, store the IN and OUT locations in the song 1 track.
- 2 Press the [EDIT] key, and then press the [SONG/TRACK] key several times to access the “Edit-Track” display.
- 3 Press the [▶] key, and then press the [SONG/TRACK] key several times to access the “Cpy” display.
- 4 Rotate the [VALUE] dial to set the source track (the track from which the data will be copied) to 1.
- 5 Press the [▶] key, and then rotate the [VALUE] dial to set the destination track (the track to which the data will be copied) to TrCLP (clipboard).

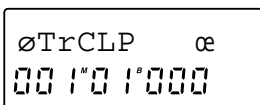

- 6 Press the [▶] key, and the display will indicate “?”. Make sure that the setting is correct. If you are sure that you wish to copy the data to the clipboard, press and hold the [▶] key for approximately one second. When the data has been copied, the display will indicate “Completed”.
- 7 Hold down the [STOP] key and press the [FF] key to recall song 2.
- 8 As described in “1. Storing IN, OUT and TO locations”, store the TO location.
- 9 Press the [EDIT] key, and then press the [SONG/TRACK] key several times to access the “Edit-Track” display.
- 10 Press the [▶] key, and then press the [SONG/TRACK] key several times to access the “Cpy” display.

- 11 Rotate the [VALUE] dial to set the source track (the track from which data will be copied) to TrCLP1.

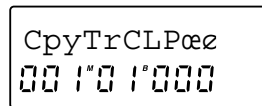

- 12 Press the [▶] key, and then rotate the [VALUE] dial to set the destination track (the track to which the data will be copied) to 1.

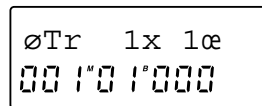

- 13 Press the [▶] key, and then rotate the [VALUE] dial to set the number of copies to 1.

- 14 Make sure that you have made the correct settings. If you are sure that you wish to execute the copy operation, press and hold the [▶] key for approximately one second. When the copy is completed, the display will indicate “Completed”. Press the [▶] key to restore the previous display.

- 15 Move to the TO location, and playback to check that the copy was performed correctly. If the data was copied to the wrong location, press the [UNDO] key to return the data to the previous condition, and then perform the copy operation once again.

Example: Copying the IN-OUT area of song 1 track 1 to the TO location of song 2 track 1 once

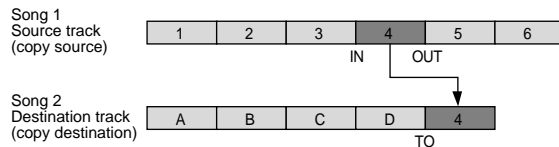

3. Inserting a blank space into the track data (Insert Track)

This operation inserts a blank space into the specified area (IN-OUT) of a recorded track. When the blank is inserted, the original data will be moved toward the end of the song to make room for the blank. A blank can be inserted into a single track, or into multiple tracks at once. If you wish to add phrases to the middle of previously recorded data, use this operation to insert a blank space of the appropriate length, and then record onto that area.

■ Inserting a blank space into the IN-OUT area of a track

As an example, here's how to insert a blank space into the IN-OUT area of track 1.

- As described in "1. Storing IN, OUT and TO locations", store the IN and OUT locations.
- Press the [EDIT] key, and then press the [SONG/TRACK] key several times to access the "Edit-Track" display.

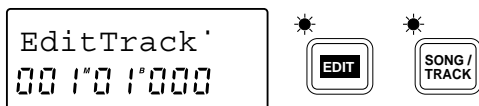

- Press the [▶] key, and then press the [SONG/TRACK] key several times to access the "Ins" display.

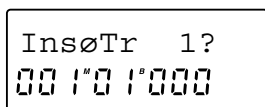

- Rotate the [VALUE] dial to set the destination track (the track into which the blank space will be inserted) to 1.
- Make sure that you have made the correct settings. If you are sure that you wish to execute the Insert Blank Space operation, press and hold the [▶] key for approximately one second. When the blank space has been inserted, the display will indicate "Completed".
- Move to the IN location, and playback to check that the blank space was inserted correctly. If it was inserted into the wrong location, press the [UNDO] key to return the data to the previous condition, and then perform the Insert Blank Space operation once again.

Example: Inserting a blank into the IN-OUT area of track 1

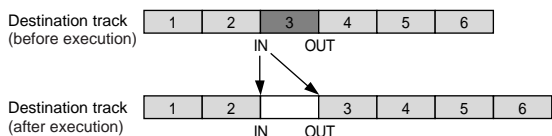

4. Erasing data from a track (Erase Track)

This operation erases data from a specified area (IN-OUT) of a recorded track. Single tracks or multiple tracks can be erased simultaneously. The erased area will be blank, and even if recorded data exists following the erased area, it will not be moved forward.

■ Erasing data from the IN-OUT area of a track

As an example, we will show how to erase the IN-OUT area of track 1.

- As described in "1. Storing IN, OUT and TO locations", store the IN and OUT locations.

- Press the [EDIT] key, and then press the [SONG/TRACK] key several times to access the "Edit-Track" display.

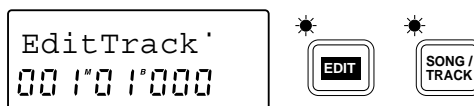

- Press the [▶] key, and then press the [SONG/TRACK] key several times to access the "Ers" display.

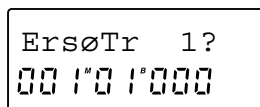

- Rotate the [VALUE] dial to set the destination track (the track from which data will be erased) to 1.
- Make sure that you have made the correct settings. If you are sure that you wish to execute the Erase Track operation, press and hold the [▶] key for approximately one second. When the data has been erased, the display will indicate "Completed". Press the [▶] key to restore the previous display.
- Move to the IN location, and playback to check that the data was erased correctly. If the wrong data was erased, press the [UNDO] key to return the data to the previous condition, and then perform the Erase Track operation once again.

Example: Erasing the data from the IN-OUT area of track 1

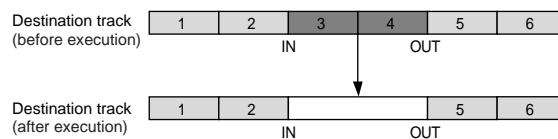

5. Deleting data from a track (Delete Track)

This operation deletes data from a specified area (IN-OUT) of a recorded track. Data can be deleted from single tracks or multiple tracks simultaneously. If recorded data exists following the deleted area, it will be moved forward to fill the gap left by the deleted IN-OUT area.

■ Deleting data from the IN-OUT area of a track

As an example, we will show how to delete the IN-OUT area of track 1.

- As described in “1. Storing IN, OUT and TO locations”, store the IN and OUT locations.
- Press the [EDIT] key, and then press the [SONG/TRACK] key several times to access the “EditTrack” display.

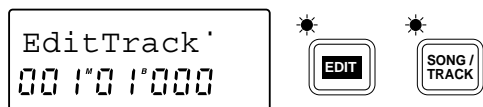

- Press the [▶] key, and then press the [SONG/TRACK] key several times to access the “Del” display.

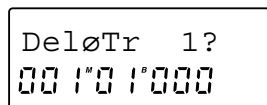

- Rotate the [VALUE] dial to set the destination track (the track from which data will be deleted) to 1.

Make sure that you have made the correct settings. If you are sure that you wish to execute the Delete Track operation, press and hold the [▶] key for approximately one second. When the data has been deleted, the display will indicate “Completed”. Press the [▶] key to restore the previous display.

- Move to the IN location, and playback to check that the data was deleted correctly. If the wrong data was deleted, press the [UNDO] key to return the data to the previous condition, and then perform the Delete Track operation once again.

Example: Deleting the data from the IN-OUT area of track 1

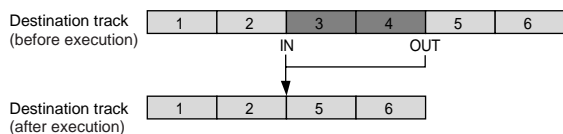

6. Exchanging data between tracks (Swap Track)

This operation exchanges data between tracks in the specified area (IN-OUT). Single tracks or multiple tracks can be swapped simultaneously.

■ Swapping the IN-OUT areas of two tracks

As an example, we will show how to swap the IN-OUT areas of track 1 and track 2.

- As described in “1. Storing IN, OUT and TO locations”, store the IN and OUT locations.
- Press the [EDIT] key, and then press the [SONG/TRACK] key several times to access the “EditTrack” display.

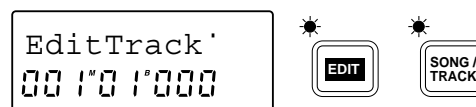

- Press the [▶] key, and then press the [SONG/TRACK] key several times to access the “SwpTr” display.

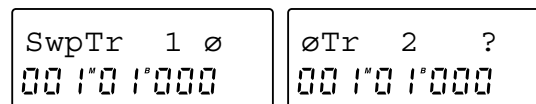

- Rotate the [VALUE] dial to set the source track (one track whose data will be swapped) to 1.
- Rotate the [VALUE] dial to set the destination track (the other track whose data will be swapped) to 2.
- Make sure that you have made the correct settings. If you are sure that you wish to execute the Swap Track operation, press and hold the [▶] key for approximately one second. When the data has been swapped, the display will indicate “Completed”. Press the [▶] key to restore the previous display.
- Move to the IN location, and playback to check that the data was exchanged correctly. If the wrong data was exchanged, press the [UNDO] key to return the data to the previous condition, and then perform the Swap Track operation once again.

Example: Swapping the data of the IN-OUT areas of track 1 and track 2



STEP 9

Song editing

This section explains song-related editing operations (copy, delete, move).



1. Copying a song

This operation copies the currently selected song from the currently selected drive to a specified song number in any drive.

- 1 Select the song that you wish to copy (and the drive which contains that song). (Refer to “Selecting another song”, p.10)
- 2 Press the [EDIT] key, and then press the [SONG/TRACK] key several times to access the “Edit-Song” display.

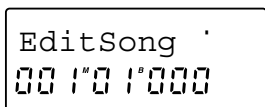

- 3 Press the [▶] key, and then press the [SONG/TRACK] key several times to select “Cpy”.

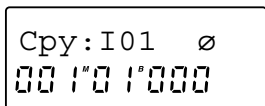

- 4 Rotate the [VALUE] dial to select any song or all songs of the copy source drive: 1-** (** is the last song number).
- 5 Press the [▶] key, and then rotate the [VALUE] dial to select the copy destination drive. If you selected all songs in step 4, the drive type (hard disk “HD” or removable disk “RM”) will be detected and displayed automatically.
- 6 If you selected an individual song in step 4, press the [▶] key, and then rotate the [VALUE] dial to select the song number to which the song will be copied.
- 7 Press the [▶] key to access the “?” display.
- 8 Press and hold the [▶] key for approximately one second. If you selected an individual song in step 4, the selected song will be copied to the specified song number of the specified drive. If you selected all songs in step 4, they will be copied to the drive that was selected in step 5, following any existing songs which already existed in that drive. When the copy has been completed, the display will indicate “Completed”, and the song number that was selected in step 1 will be recalled. Press the [▶] key to restore the previous display.



2. Deleting a song

This operation deletes the currently selected song.

- 1 Select the song that you wish to delete. (Refer to “Selecting another song”, p.10)

It is not possible to use the Undo function to recover a song that has been deleted. When you execute the Delete operation, the song will be lost forever. Before deleting a song, be sure to play it back to verify that the selected song is really the one that you intend to delete.

- 2 Press the [EDIT] key, and then press the [SONG/TRACK] key several times to access the “Edit-Song” display.
- 3 Press the [▶] key, and then press the [SONG/TRACK] key several times to select “Del”. Displayed next to it will be the drive number and the song number, so verify these. (In the example display shown below, I04 indicates song number 4 of the internal drive.)

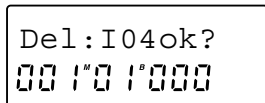

- 4 Press and hold the [▶] key for approximately one second to delete the song. When the song has been deleted, the display will indicate “Completed”, and the song number following the deleted song will be recalled. Press the [▶] key to restore the previous display.



3. Moving a song

This operation moves the currently selected song to a different song number in the same drive.

- 1 Select the song that you wish to move. (Refer to “Selecting another song”, p.10)
- 2 Press the [EDIT] key, and then press the [SONG/TRACK] key several times to access the “Edit-Song” display.
- 3 Press the [▶] key, and then press the [SONG/TRACK] key several times to select “Mov”.

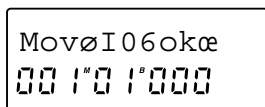

- 4 Rotate the [VALUE] dial to select the song number in the current drive to which the song will be moved.
- 5 Press the [▶] key to access the “?” display.
- 6 Press and hold the [▶] key for approximately one second to move the song. When the song has been moved, the display will indicate “Completed”, and the currently selected song number will be recalled from the number to which it was moved. Press the [▶] key to restore the previous display.



4. Song Recover

This operation restores the currently selected song to the condition in which it was immediately after it was selected. At this time, a copy of the current state of the song will automatically be created in the next song number (refer to p.45).

STEP 10 Tempo settings

The tempo of D8 songs can be set using Tempo Maps, MIDI Clock, or Tap Tempo. In addition to managing the tempo, these settings will also control the tempo when external MIDI devices are synchronized to the D8. This section explains how to adjust these tempo settings.

1. Tempo map settings

A “tempo map” is a tempo change (time signature and tempo) that can be specified for an individual measure. The specified time signature and tempo will take effect at the specified measure. There are ten tempo maps; tempo map 0 is located at the beginning of the song and is the initial tempo of the song, and tempo maps 1-9 can be placed in measures during the song to modify the time signature and tempo.

■ Creating a tempo map

- 1 Press the [TEMPO] key to display the tempo map number, tempo and time signature.

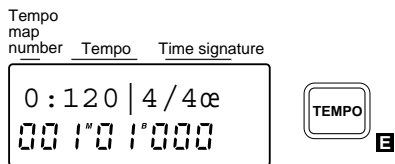

- 2 To set the initial tempo for the song, rotate the [VALUE] dial to select tempo map 0. To modify the time signature and tempo at a measure during the song, select a tempo map number 1-9.
- 3 Press the [▶] key, and then rotate the [VALUE] dial to set the tempo.
- 4 Press the [▶] key, and then rotate the [VALUE] dial to set the time signature.
- 5 Specify the measure at which the tempo and time signature will change. Simultaneously press the [◀] and [▶] keys to move the cursor to the location counter.

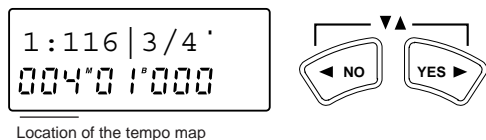

- 6 Press the [◀] or [▶] key, and then rotate the [VALUE] dial to specify the measure.
- 7 Press a key other than [TEMPO] to exit this page, and the song map will automatically be renumbered as appropriate for its measure location, and assigned.

About the metronome patterns

By specifying a different metronome pattern for each tempo map, you can create a rhythm track with a variety of patterns. using just the D8's metronome. (Refer to “■ Selecting the metronome pattern”, p.21)

■ Deleting a tempo map

- 1 Press the [TEMPO] key to display the tempo map number, tempo and time signature.

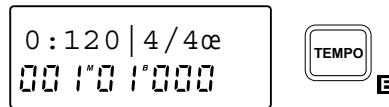

- 2 Rotate the [VALUE] dial to select the number of the tempo map that you wish to delete. The location counter in the lower line will allow you to confirm the location of the tempo map that will be deleted.

⚠ Since the tempo maps are re-numbered automatically so that they will be consecutive, the number of a tempo map may not be the same as when you created it.

- 3 Simultaneously press the [◀] and [▶] keys to move the cursor to the location counter.

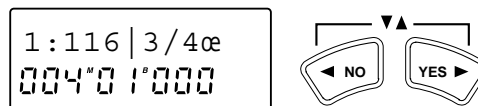

- 4 Rotate the [VALUE] dial to set the measure location to 000.
- 5 When you press a key other than the [TEMPO] key to exit this page, the tempo map whose measure location was set to 000 will be deleted.

2. Recording MIDI Clock data from a sequencer

Tempo data from a song that was created on a MIDI sequencer can be recorded on the D8, so that this data can be used to manage the D8's tempo. This is convenient when you wish to synchronize the song data with D8 song data, or when you wish to modify the D8 song tempo in a continuous fashion.

■ Recording tempo data on the D8

- 1 If the song data contains irregular time signatures, create tempo maps on the D8 to specify the appropriate time signatures.
- 2 Connect the MIDI OUT connector of the MIDI sequencer to the MIDI IN connector of the D8.
- 3 Adjust the settings on the MIDI sequencer so that it will transmit MIDI Clock messages. (For details refer to the owner's manual of your MIDI sequencer.)

- 4 Press the [EDIT] key, and then press the [TEMPO] key several times to make the display read “TempoRec”.

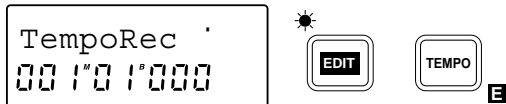

- 5 Press the [▶] key, and then rotate the [VALUE] dial to select **MIDIclk** (MIDI Clock) as the tempo source that will be recorded.

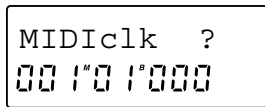

- 6 Press and hold the [▶] key for approximately one second so that the D8's display reads “StartSEQ”. The D8 will wait for MIDI Clock messages to arrive.
 - 7 Start the MIDI sequencer. When the MIDI Start message is received from the MIDI sequencer, the D8's display will indicate “Working”.
 - 8 When the MIDI sequencer stops playback, recording will be completed and the D8 will indicate “Complete”.
-  If MIDI Clock messages are not transmitted correctly from the MIDI sequencer, recording may terminate before the end of the song.

3. Recording tap tempo

While playing back a song, you can record tempo data by pressing (tapping) the [PLAY] key or the foot switch at the beginning of each measure. This allows tempo data to be recorded onto a previously-recorded song. This is convenient when you wish to perform track editing in measure units on a song for which tempo was not specified, or when you wish to connect and synchronize an external MIDI device.

- 1 From the beginning of the song, record the audio source whose tempo you wish to record. In order to record accurately from the beginning of the song, it is convenient to use Trigger Recording. (Refer to “Trigger recording”, p.22)
 - 2 If the data contains irregular time signatures, create tempo maps on the D8 to specify the appropriate time signatures.
-  If you fail to do this, the data will be detected as an incorrect tempo.
- 3 If you wish to use a foot switch to input the tap tempo, or if you wish to use both a foot switch and the [PLAY] key to input the tap tempo, connect the foot switch (PS-1, PS-2 etc.) to the D8's FOOT SW jack.

- 4 Press the [EDIT] key, and then press the [TEMPO] key several times to make the display read “TempoRec”.

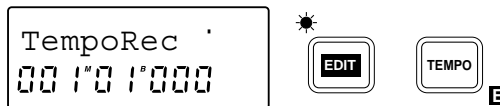

- 5 Press the [▶] key, and then rotate the [VALUE] dial to select **MeasTap** (record taps at the beginning of each measure) as the tempo source for recording.

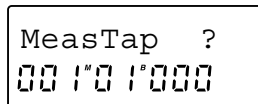

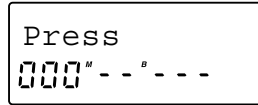
- 6 Press and hold the [▶] key for approximately one second. The D8's display will alternately show “Press” and “Play/Fsw”, and it will wait for taps to be entered.
- 
- 7 Press the [PLAY] key or the foot switch (which will always be automatically set to Tap Marker when tap tempo is being recorded) to begin playback. The display will indicate “Play/Fsw”, and the first tap will be input.



- 8 At the beginning of each measure, press the [PLAY] key or the foot switch (both will be valid) to enter the taps. For example if you wish to tap four measures, you would tap until the beginning of the fifth measure.
- 9 After inputting the last tap, press the [STOP] key to finish. If the song tempo is basically constant, you need not enter taps all the way to the end. In this case, the tempo of the measure that was last tapped will be automatically copied until the end of the song.

4. Selecting the tempo source

- 1 Press the [EDIT] key, and then press the [TEMPO] key several times to make the display read “TmpSrc”.

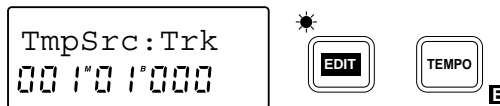

- 2 Press the [▶] key, and then rotate the [VALUE] dial to select the tempo source that you wish to use. Select **Map** if you wish to use tempo maps, or select **Trk** if you wish to use MIDI Clock data or tap tempo data that was recorded. After MIDI Clock data or tap tempo data is recorded, this will automatically be set to **Trk**. Also, if MIDI Clock or Tap Tempo data has not been recorded, it will not be possible to select **Trk**.

STEP 11 Synchronization and control with a MIDI sequencer

This section explains how a MIDI sequencer can be synchronized to the D8, and how recording and playback on the D8 can be controlled from a MIDI sequencer.

“Synchronization” refers to a condition in which a D8 and a MIDI sequencer or rhythm machine etc. can be operated at the same timing. The device that is outputting the synchronization clock is called the “master”, and the device that is receiving the synchronization clock and synchronizing to it is called the “slave”. The D8 can be used as the master. It is also possible to control recording or playback on the D8 by transmitting MMC messages from a MIDI sequencer etc.

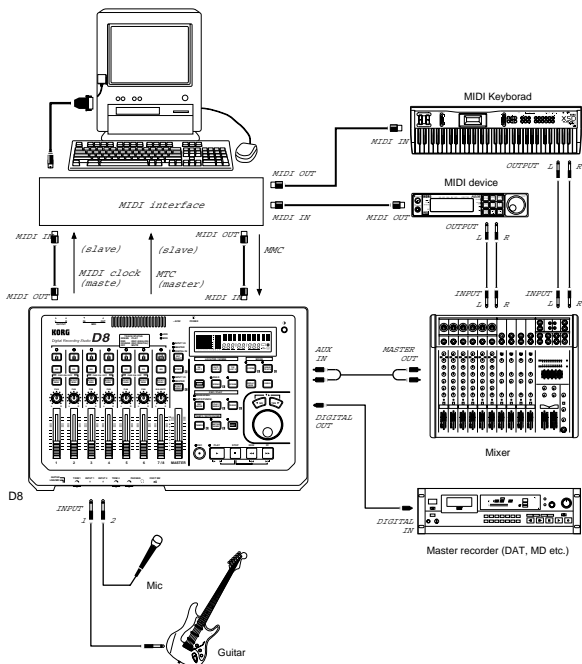

1. Using MIDI Clock to synchronize a MIDI sequencer to the D8

Here's how the D8 can be used as the master, so that a slave MIDI sequencer will synchronize to the MIDI Clock messages transmitted from the D8.

- 1 Use a MIDI cable to connect the D8's MIDI OUT connector to the MIDI IN connector of the MIDI sequencer.
- 2 Press the [EDIT] key, and then press the [SYSTEM] key several times to make the display read "MIDI/ Sync".

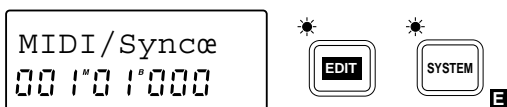

- 3 Press the [▶] key, and then press the [SYSTEM] key several times to make the display read "Gen".

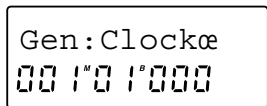

- 4 Rotate the [VALUE] dial to select **Clock**.
- 5 Adjust the settings on the MIDI sequencer so that MIDI Clock messages from an external device will be received. (For details refer to the owner's manual for your MIDI sequencer.)
- 6 Start the MIDI sequencer (it will be in playback-ready mode).
- 7 Press the [PLAY] key of the D8 to begin playback, and the MIDI sequencer will start playback at the tempo specified by the D8.

2. Using MTC to synchronize a MIDI sequencer to the D8

Here's how the D8 can be used as the master, so that the slave MIDI sequencer will synchronize to the MTC (MIDI Time Code) messages transmitted from the D8.

You will need to use a MIDI sequencer that supports MTC. If your MIDI sequencer does not support MTC, you must use MIDI Clock for synchronization.

- 1 Use a MIDI cable to connect the D8's MIDI OUT connector to the MIDI IN connector of the MIDI sequencer.
- 2 Press the [EDIT] key, and then press the [SYSTEM] key several times to make the display read "MIDI/ Sync".

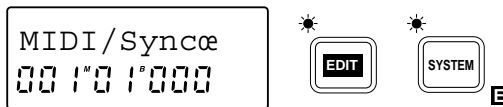

- 3 Press the [▶] key, and then press the [SYSTEM] key several times to make the display read "Gen".

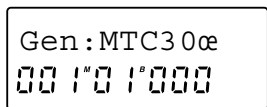

- 4 Rotate the [VALUE] dial to select **MTC30**.
- 5 Adjust the settings on the MIDI sequencer so that MTC messages from an external device will be received. (For details refer to the owner's manual for your MIDI sequencer.)
- 6 Start the MIDI sequencer (it will be in playback-ready mode).
- 7 Press the [PLAY] key of the D8 to begin playback, and the MIDI sequencer will start.

3. Using MMC to control the D8 from a MIDI sequencer

MMC (MIDI Machine Control) messages transmitted from a MIDI sequencer can control stop, playback, fast-forward, rewind, rewind and locate operations on the D8.

▲ To do this, your MIDI sequencer must support MMC. If your MIDI sequencer does not support MMC, this type of control will not be available.

- 1 Use a MIDI cable to connect the D8's MIDI IN connector to the MIDI OUT connector of the MIDI sequencer.
- 2 Make settings on the MIDI sequencer so that it will transmit MMC to control an external device. (Refer to the owner's manual for your MIDI sequencer.)
- 3 Press the [EDIT] key, and then press the [SYSTEM] key several times to make the display read "MIDI/Sync".



- 4 Press the [▶] key, and then press the [SYSTEM] key several times to make the display read "RcvMMC".

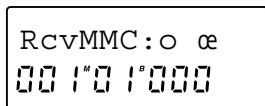

- 5 Rotate the [VALUE] dial to select 0 (On).
- 6 Press the [◀] key to move the cursor to "RvcMMC", and press the [SYSTEM] key to make the display read "DevID".

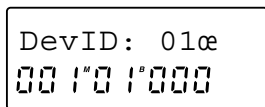

- 7 Rotate the [VALUE] dial to set the Device ID of the D8 to the same setting as the MMC Device ID of your MIDI sequencer.
- 8 When you stop, playback, fast-forward, rewind, record or locate on your MIDI sequencer, the D8 will be controlled accordingly. (For details refer to the owner's manual for your MIDI sequencer.)
 - ◇ In this setup, MTC (or MIDI Clock) messages can be transmitted from the D8 to synchronize the MIDI sequencer, so that stop, playback, fast-forward, rewind, record and locate operations on the MIDI sequencer will cause the D8 to synchronize with the MIDI sequencer. (Refer to "2. Using MTC to synchronize a MIDI sequencer to the D8" and "1. Using MIDI Clock to synchronize a MIDI sequencer to the D8".)

STEP 12 Using external drives

This section explains how an external drive such as a hard disk or removable disk can be connected and initialized, and how you can backup/restore songs using a removable disk drive.

1. Connecting an external drive

Up to 7 external drives such as hard disks or removable disks* can be connected to the D8. The maximum capacity of each external drive is 4 Gbytes. Use a D-sub 25 pin SCSI cable to make connections.

* In this manual, the term "removable disk drive" is used to refer collectively to all types of drives from which the disk can be removed.

- 1 Turn off the power of the D8 and of the external drive.

▲ You must turn off the power of the D8 and of the drive before connecting or disconnecting SCSI cables or changing the SCSI ID number of a drive.

- 2 Set the SCSI ID (0-6) of the external drive. Select as low a SCSI ID number as possible. If more than one external drive is connected, adjust the settings so that the numbers do not overlap. (For details on setting the SCSI ID of an external drive, refer to the owner's manual for the external drive.)

▲ If two or more drives are set to the same ID number, malfunctions and/or loss of data can occur.

- 3 Connect the D8's SCSI connector to the SCSI connector of the external drive.

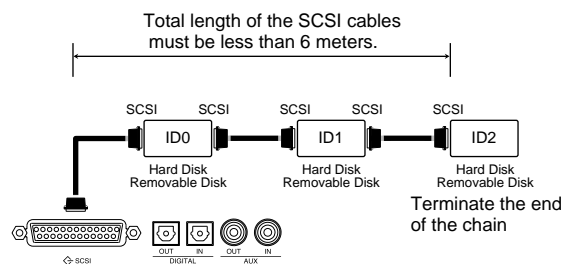

▲ Be sure to attach (or switch on) the terminator for the last drive in the chain. If more than one external drive is connected, make sure that the total length of the cable does not exceed 6 meters. (For details on connections, refer to the owner's manual for your external drive.)

2. Turning the power on/off when an external drive is connected

Turning the power on

- Turn on the power of the external drive(s), and then turn on the power of the D8.

Turning the power off

- When turning the power off, first turn off the power of the D8, and then turn off the power of the external drives.

However if the currently selected song is on a removable disk drive, turning off the power of the D8 when the disk is still in the drive will make it impossible to remove the disk even if you press the eject key of the removable disk drive. As necessary, remove the disk as follows before you turn off the power.

If the currently selected song is not on a removable disk drive, you can press the eject key of the removable disk drive to remove the disk.

- Press and hold the [◀] and [▶] keys to get the “Eject→*?” display which asks whether you wish to eject a disk (* is the SCSI ID A–G of the drive).

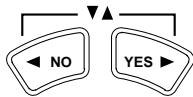
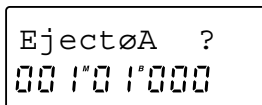

- If you wish to eject the disk, press and hold the [▶] key for approximately one second. The disk will be ejected, and the display will read “Next/PwOff”, telling you that you may either insert the next disk or turn off the power.

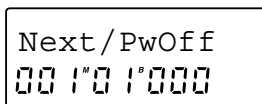

- Turn off the power as described above (⇄).

3. Initializing and formatting a drive

Here’s how you can initialize or format a connected external drive. Select Initialize when you have purchased a drive or when you wish to completely erase the contents of the drive. Select Format when you wish to use a disk that was previously used by another device, or when a Disk Error display begins to appear frequently during playback etc.

When you initialize or format, all data that had been saved on that disk will be lost. Before you initialize or format, check to make sure that you actually want to do this.

- Press the [EDIT] key, and then press the [SYSTEM] key several times to make the display read “DiskUtil”.

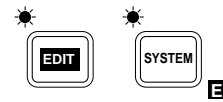
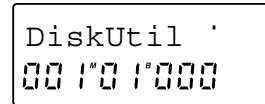

- Press the [▶] key, and then press the [SYSTEM] key several times to make the display read “Initial”.

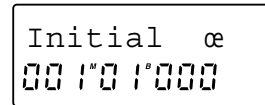

- Press the [▶] key, and then rotate the [VALUE] dial to select the drive number (SCSI ID A–G) that you wish to initialize or format. When you select a drive number, the drive type “HD” (hard disk) or “RM” (removable disk) will appear beside the drive number.

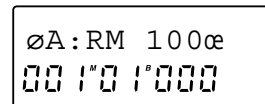

- If you are sure that you wish to initialize or format the disk, press and hold the [▶] key for approximately one second. While the operation is being executed, the display will indicate “Working”. When the operation is finished, the display will indicate “Completed”. Press the [▶] key to restore the previous display.

4. Exchanging disks on a removable disk drive

Exchanging disks on the currently selected removable disk drive

If the currently selected song is on a removable disk drive, use the following procedure to exchange disks.

- Press and hold the [◀] and [▶] keys to get the “Eject→*?” display which asks whether you wish to eject a disk (* is the SCSI ID A–G of the drive).

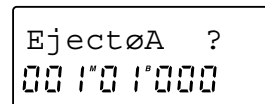

- Press and hold the [▶] key for approximately one second. The disk will be ejected, and the display will read “Next/PwOff”, telling you that you may either insert the next disk or turn off the power.

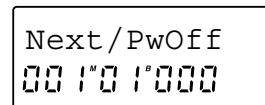

- 3 Insert another disk into the removable disk drive. If you insert an uninitialized disk, the display will read "Init→*?" (* is the SCSI ID A-G of the drive), asking whether you wish to initialize the disk. If you wish to initialize, press and hold the [▶] key for approximately one second to initialize the disk. (Refer to "3. Initializing and formatting a drive")

■ Exchanging disks on a removable disk drive which is not currently selected

If the currently selected song is on a drive other than the removable disk drive, use the following procedure to exchange disks.

- ◇ Press the Eject key of the external removable disk drive to remove the disk, and insert a different disk. (For the location of the Eject key, refer to the owner's manual for your removable disk drive.)

If the disk is unformatted, refer to "3. Initializing and formatting an external drive".

5. Saving a song on a removable disk drive (Backup)

There are two ways in which a song can be saved on an external disk: Song Copy and Backup. Song Copy and Backup differ in the following ways.

Song Copy	Backup
The song can be selected and played	The song cannot be selected (you must Restore before the song can be selected)
The save destination song number can be specified	The song is always overwritten, and the song number cannot be specified
Song data extending over multiple disks cannot be saved	Song data extending over multiple disks can be saved
A hard disk drive or removable disk drive can be used	A removable disk drive or DAT can be used

If you wish to save a song by copying it to an external hard disk drive or removable disk drive, refer to "Copying a song" (p.35).

This section will explain how to backup a song to a removable disk drive. For the procedure of backing up to a DAT recorder, refer to "1. Saving a song to a DAT recorder (Backup)" (p.43).

- ⚠ Korg will accept no responsibility for any loss of data which may result from failure to backup/restore correctly.

■ Backing up a song to a removable disk drive

- 1 Press the [EDIT] key, and then press the [SONG TRACK] key several times to display the song name (EDIT SONG/TRACK P1).

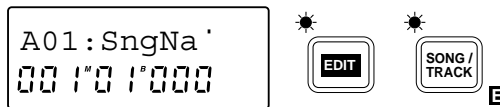

- 2 Press the [◀] key, and then rotate the [VALUE] dial to select the drive which contains the song that you wish to backup. If you are backing up an individual song, press the [▶] key and then rotate the [VALUE] dial to select the song number as well.

- 3 Press the [SYSTEM] key several times to make the display read "DiskUtil".

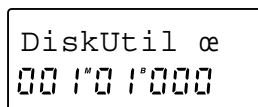

- 4 Press the [▶] key, and then press the [SYSTEM] key several times to make the display read "Backup".

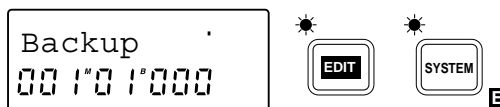

- 5 Press the [▶] key. The drive and song number that you selected in step 2 will be displayed. If you wish to backup all songs in the currently selected drive, rotate the [VALUE] dial to select 1-** (All). If you wish to backup an individual song, leave this setting unchanged.

- 6 Press the [▶] key, and then rotate the [VALUE] dial to specify the backup destination drive (A-G).

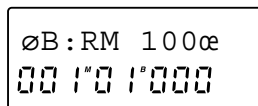

- 7 Press the [▶] key, and the display will indicate the number of disks that you will need. Prepare the appropriate number of disks of the same capacity as the disk that is currently in the drive.

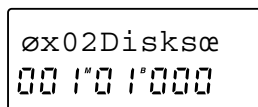

- 8 Press the [▶] key, and the contents of the backup will be displayed. Press the [▶] key. The display will indicate "Over Wrtok?", asking you to confirm that you wish to overwrite the backup destination disk. If you wish to execute the backup operation, press and hold the [▶] key for approximately one second.

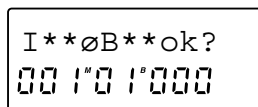

- If the backup extends across multiple disks, the first disk will be ejected when it is full, and the display will indicate "InsNextDsk", asking you to insert the second disk. Remove the first disk and insert the second, and the operation will continue.

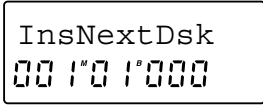

- When backup is completed, the display will indicate "Completed". Press the [▶] key to restore the previous display.



6. Loading a song that was backed up on a removable disk drive (Restore)

"Restore" refers to the process of loading a song that was backed up on a removable disk drive or a DAT recorder. Here we will explain how to restore from a removable disk drive.

■ Loading a song that was backed up on a removable disk drive (Restore)

- Press the [EDIT] key, and then press the [SYSTEM] key several times to make the display read "DiskUtil".

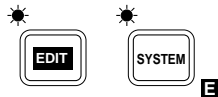
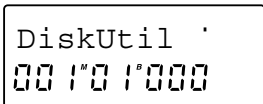

- Press the [▶] key, and then press the [SYSTEM] key several times to make the display read "Restore".

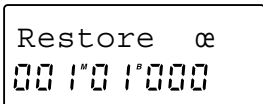

- Press the [▶] key, and then rotate the [VALUE] dial to select the drive (I, A-G) from which the song will be restored. When you select a drive, the type and capacity of that drive will be shown.

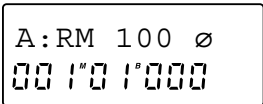

- Press the [▶] key, and then rotate the [VALUE] dial to select the song that you wish to restore. Select a number 01-50 to restore an individual song from the drive that was specified in step 3, or select 1-** (All) to restore all songs from that drive.

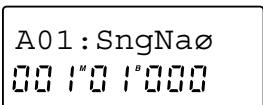

- Press the [▶] key. At this time, the display will be different, depending on the selection you made in step 4 (restoring an individual song or all songs).

If you are restoring only one song, rotate the [VALUE] dial to select the restore destination drive (A-G). Then press the [▶] key, and rotate the [VALUE] dial to select the restore destination song number.

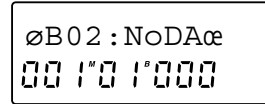

If you are restoring all songs, rotate the [VALUE] dial to select the restore destination drive (A-G). The capacity of that drive will be shown beside the drive designation.

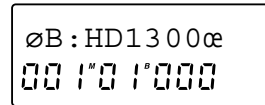

- Press the [▶] key, and the display will indicate "?", asking you to confirm the operation. When you execute the restore operation for a single song, the song will be loaded into the specified number, and any songs which follow the restore destination number will be renumbered upward.

When you execute the restore operation for all songs, the data will overwrite the specified drive.

- Be aware that if all songs are restored, all data of the restore destination will be lost.

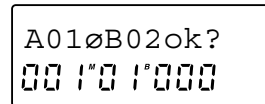

- If you are sure you wish to execute the restore operation, press and hold the [▶] key for approximately one second.

- If the restore operation extends across multiple disks, the first disk will be ejected when it has been restored, and the display will indicate "InsNextDsk", prompting you to insert the second disk. Remove the first disk and insert the second disk, and the operation will continue.

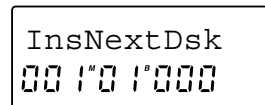

- When restoring all songs, the display will indicate "OvWrtEff?" before the operation ends.

If you want the user effects that were saved in the restore source (RM/DAT) to overwrite the user effects that are currently being used, press and hold the [▶] key for approximately one second. If you want to continue using the current effect data (i.e., without overwriting it), press and hold the [◀] key for approximately one second.

- When restore is completed, the display will indicate "Completed". Press the [▶] key to restore the previous display.

STEP 13

Saving to and loading from DAT

This section explains how song data can be backed up to a DAT recorder, and then restored from the DAT recorder.

- ⚠ Korg will take no responsibility for any loss of data which may result from the inability to backup/restore correctly.
- ⚠ Backup to a DAT recorder is limited to the amount of data that will fit on a single 120 minute tape.
- ⚠ It is not possible to backup to a digital audio device other than a DAT recorder (e.g., MD recorder, DCC recorder or ADAT).
- ⚠ Be sure that the audio equipment connected to the DAT recorder has been turned down to the minimum volume, so that the sound from the DAT recorder is not output from speakers or headphones. If you playback the DAT with the volume raised, your speakers or hearing may be damaged.

1. Saving a song to a DAT recorder (Backup)

Here will explain how to backup a song from the D8 to a DAT recorder.

- 1 Connect the DIGITAL OUT connector of the D8 to the DIGITAL IN connector of your DAT recorder. Adjust the settings on your DAT recorder so that the input from its DIGITAL IN will be recorded. (For details on DAT settings, refer to the owner's manual for your DAT recorder.)

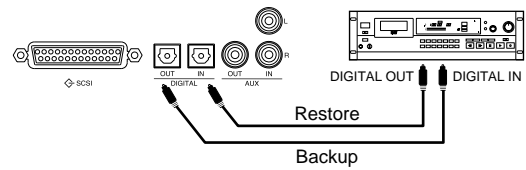

- 2 Press the [EDIT] key, and then press the [SONG TRACK] key several times to display the song name.

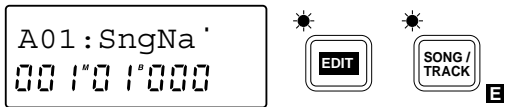

- 3 Press the [◀] key, and then rotate the [VALUE] dial to select the drive which contains the song that you wish to backup. If you wish to backup a single song, press the [▶] key and then rotate the [VALUE] dial to select the song number as well.

- 4 Press the [SYSTEM] key several times to make the display read "DiskUtil".

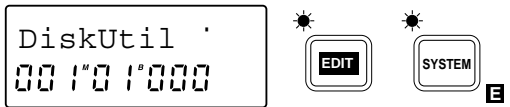

- 5 Press the [▶] key, and then press the [SYSTEM] key several times to make the display read "Backup".

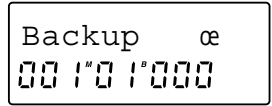

- 6 Press the [▶] key. The drive and song number that you selected in step 3 will be displayed. If you wish to backup all songs of the currently selected drive, rotate the [VALUE] dial to select 1-** (All). If you wish to backup an individual song, leave the selection as it is.

- 7 Press the [▶] key, and then rotate the [VALUE] dial to select the DAT "H" as the backup destination drive. The display will indicate the required length of tape, so use a tape of greater length than this.

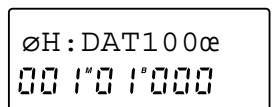

- 8 Press the [▶] key, and the contents of the backup will be displayed.



- 9 Press the [▶] key, and the display will alternately indicate "RecDAT" and "RecStart_?", prompting you to begin recording on the DAT recorder. Start recording from the beginning of the DAT tape.

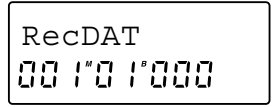

- 10 After you have started recording on the DAT recorder, press and hold the [▶] key for approximately one second to begin the backup.

- 11 When the backup is completed, the display will alternately indicate "Completed" and "StopDAT". Stop the DAT recorder.

2. Loading a backed-up song from a DAT recorder (Restore)

Here's how to restore a song that was backed-up on a DAT recorder. If you backed up 1-** (All), all songs will be restored. If you backed up an individual song, that song will be restored.

■ Loading a backed-up song from a DAT recorder (Restore)

- 1 Connect the DIGITAL IN connector of the D8 to the DIGITAL OUT connector of your DAT recorder.
- 2 Press the [EDIT] key, and then press the [SYSTEM] key several times to make the display read "DiskUtil".

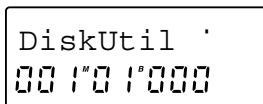

DiskUtil
00 1'0 1'000

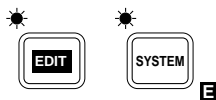

- 3 Press the [▶] key, and then press the [SYSTEM] key several times to make the display read "Restore".



Restore α
00 1'0 1'000

- 4 Press the [▶] key, and then rotate the [VALUE] dial to select DAT "H" as the drive from which the data will be restored.

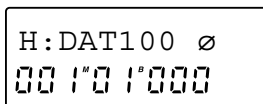

H:DAT100 ø
00 1'0 1'000

- 5 Press the [▶] key to make the display read "PlayDAT". Then playback the DAT recorder.
- 6 As playback continues, the D8 will indicate "StopDAT", so stop the DAT recorder.
- 7 You can press the [▶] key to verify the song names that are on the DAT tape. If you performed the backup using 1-** (All), you can rotate the [VALUE] dial to see the other song names.
- 8 If you wish to continue the Restore operation, press the [▶] key. The display will differ, depending on whether you restore a single song or all songs.

To restore a single song, rotate the [VALUE] dial to select the restore destination drive A-G. Then press the [▶] key, and rotate the [VALUE] dial to select the restore destination song number.

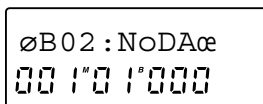

øB02:NøDAα
00 1'0 1'000

To restore all songs, rotate the [VALUE] dial to select the restore destination drive A-G. The capacity of that drive will be displayed beside the selection.

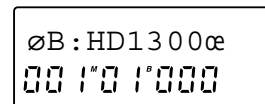

øB:HD1300α
00 1'0 1'000

If you wish to restore from another DAT tape, press the [◀] key and continue the procedure from step 4.

- 9 Press the [▶] key, and the display will read "?", asking for your confirmation.

If you execute the Restore operation for a single song, the song will be loaded into the specified number, and songs following that number will be renumbered upward by one.

If you execute the Restore operation for all songs, the display will read "OverWrtok?", asking whether it is OK to overwrite the restore destination drive. If you execute the operation, the data will be overwritten to the specified drive.

- Be aware that All Song Restore will cause all data of the restore destination drive to be lost.

- 10 If you are sure that you wish to execute the Restore operation, press and hold the [▶] for approximately one second. The display will read "PlayDAT", requesting you to playback the DAT recorder.

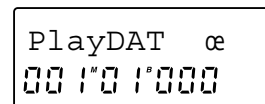

PlayDAT α
00 1'0 1'000

- 11 Start playback from the beginning of the DAT tape, and the process of restoring the data will begin.
- 12 When restoring all songs, the display will indicate "OvWrtEff?" before the operation ends. If you want the user effects that were saved in the restore source (RM/DAT) to overwrite the user effects that are currently being used, press and hold the [▶] key for approximately one second. If you want to continue using the current effect data (i.e., without overwriting it), press and hold the [◀] key for approximately one second.
- 13 When the backup is completed, the display will alternately indicate "Completed" and "StopDAT". Stop the DAT recorder. Press the [▶] key to restore the previous display.

Chapter 3 Reference

This chapter explains the parameters that appear in the display when you press the various keys of the D8, and the function of each key and fader.

The numbers shown in the following diagram correspond to the references numbered below.

For example, if you wish to learn about the parameters that are displayed when you press the [SONG/TRACK] key which is marked “1, 2” you can refer to “1. SONG/TRACK” for information on the parameter functions. Notice that there is an **E** at the lower right of the [SONG/TRACK] key. By first pressing the [EDIT] key and then pressing a key that carries this indication, you can enter EDIT mode. These parameter functions are explained in “2. EDIT SONG/TRACK”. If the displayed functions occupy two or more pages, you can press that key to select pages. Parameter functions are explained in the “PX XXXXXXXX” item.

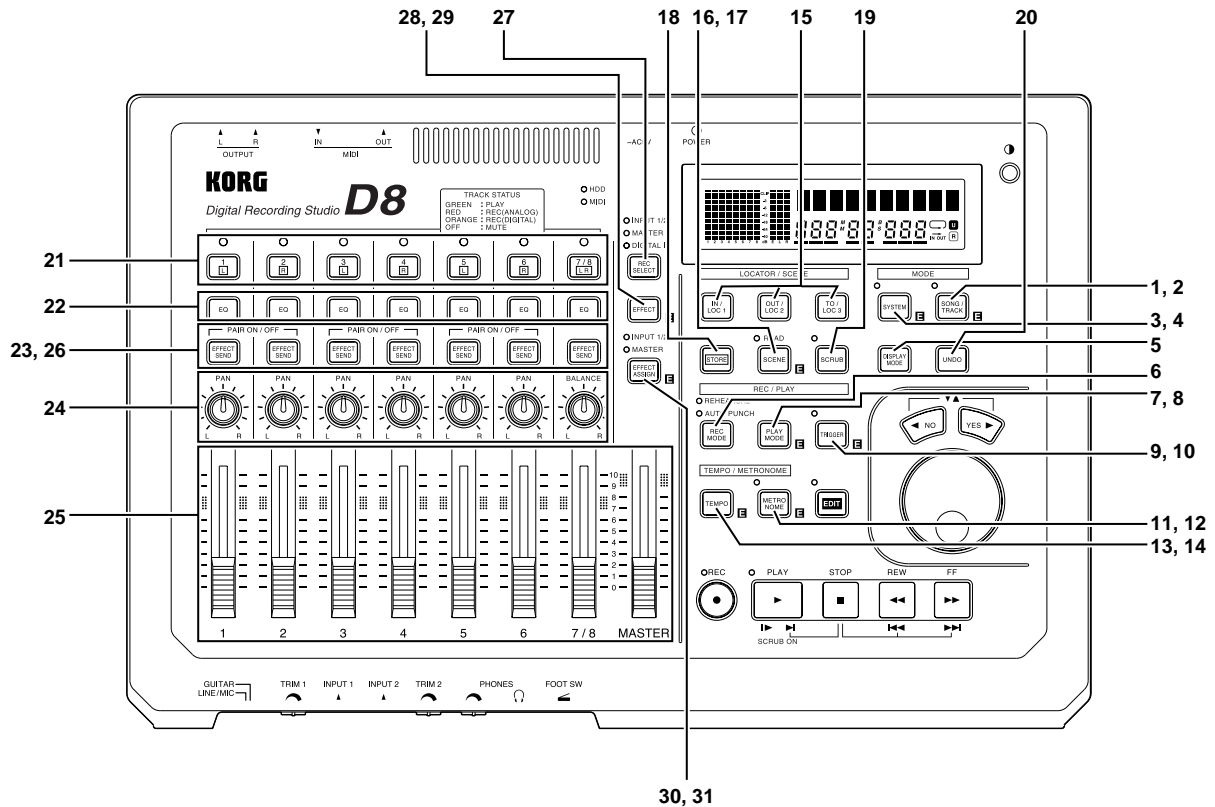

1. SONG/TRACK..... 44	6. REC MODE.....51	20. UNDO..... 57
P1 Song number/name display... 44	7. PLAY MODE..... 51	21. TRACK STATUS..... 58
2. EDIT SONG/TRACK..... 44	8. EDIT PLAY MODE..... 52	22. EQ..... 58
P1 Drive/song select 44	P1 Pre roll time setting 52	P1 High EQ gain adjustment 58
P2 Edit song 44	P2 Post roll time setting 52	P2 Low EQ gain adjustment 58
P3 Edit Track..... 46	P3 Program play 52	23. EFFECT SEND..... 58
3. SYSTEM..... 47	9. TRIGGER..... 52	P1 Effect send level (Snd)
P1 Channel level meter display	10. EDIT TRIGGER..... 53	adjustment 58
selection 47	P1 Threshold level adjustment 53	P2 External output (Aux) level
P2 Effect level meter display	P2 Pre trigger time setting 53	setting 59
selection 47	11. TEMPO 53	24. PAN/BALANCE..... 59
P3 Input monitor selection 47	P1 Tempo map settings..... 53	25. FADER..... 59
P4 Foot switch operating mode	12. EDIT TEMPO 54	26. PAIR On/Off..... 60
selection 47	P1 Tempo source setting 54	27. REC SELECT..... 60
P5 Foot switch polarity setting 47	P2 Tempo recording 54	28. EFFECT..... 61
4. EDIT SYSTEM 48	13. METRONOME 54	P1 Effect select 61
P1 Deleting a mark 48	14. EDIT METRONOME 55	P2 Editing and saving an effect... 63
P2 MIDI/SYNC settings 48	P1 Metronome volume setting..... 55	29. EDIT EFFECT 63
P3 Channel pair enable setting 48	P2 Metronome mode setting..... 55	P1 Monitor delay settings 62
P4 INPUT 1/2 assign..... 48	15. IN/LOC1, OUT/LOC2, TO/LOC3..... 55	30. EFFECT ASSIGN..... 64
P5 Drive information/song	16. SCENE..... 56	P1 Effect return level setting..... 64
backup/ restore/initialize/	17. EDIT SCENE 56	P2 Effect return balance setting... 64
format..... 49	P1 Scene parameter list..... 56	P3 External input (AUX IN) level
^Drive information..... 49	P2 Deleting a scene..... 56	setting 64
^Song backup..... 49	18. STORE..... 57	P4 External input (AUX IN) balance
^Song restore 50	P1 Storing IN/LOC 1, OUT/LOC 2,	setting 64
^Initialize/format..... 50	TO/LOC 3 or a Scene 57	
5. DISPLAY MODE..... 51	P2 Storing a Mark 57	
P1 Counter display selection..... 51	19. SCRUB..... 57	

1. SONG/TRACK

P1 Song number/name display

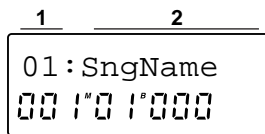

P1-1 Song number display(01...50)

This indicates the number of the song in the currently selected drive. A drive can contain up to 50 songs (memory permitting). The only songs that can be selected are those which already exist, and 01 (New empty song).

For details on selecting a song, refer to "Selecting another song" (p.9).

P1-2 Song name display(7 characters displayed: 16 characters during recording or playback)

This indicates the name (up to 7 characters) of the currently selected song.

When you begin playback or recording, the display will scroll to show the entire song name (up to 16 characters).

◇ To change the song name, use Edit Song/Track P2.

2. EDIT SONG/TRACK

P1 Drive/song select

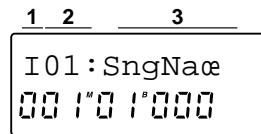

P1-1 Drive number select.....[I, A...G]

Selects the drive that you wish to use.

I: Internal IDE (internal drive), A: SCSI ID 0, B: SCSI ID 1, C: SCSI ID 2, D: SCSI ID 3, E: SCSI ID 4, F: SCSI ID 5, G: SCSI ID 6

P1-2 Song number select [01...50]

Selects the song from within the drive that was selected in P1-1. The only songs which can be selected are those which already exist, and 01 (New empty song).

P1-3 Song name display..... (16 characters displayed)

The entire name (up to sixteen characters) of the song selected in P1-2 is displayed. In P1-2 you can press the [▶] key to scroll the name.

P2 Edit song

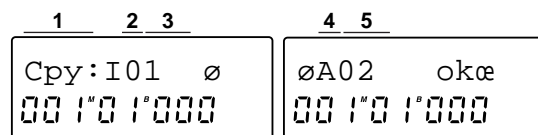
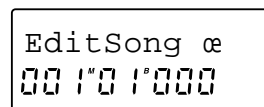

P2-1 Select a song edit operation..... [Cpy, Renam, Del, Mov, Recov]

Select the type of editing that you wish to perform. When "EditSong" is displayed, press the [▶] key, and then press the [SONG/TRACK] to make your selection.

Cpy (Copy Song [Current Song→Dest Drive, Dest Song]):

This operation copies the contents of the currently selected song or of all songs in the drive to the specified drive.

When copying a single song, the data will be copied to the specified song number of the destination drive. The destination song number and subsequent numbers will be incremented by one.

When copying all songs, the data will be copied after the last song which exists in the destination drive.

Renam (Rename Song [→Dest Drive, Dest Song, Dest Song Name 16 characters]):
This operation changes the name of the specified song in the specified drive. (Refer to "2. Naming a song", p.9)

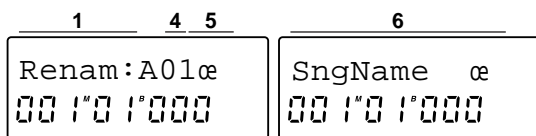

Del (Delete Song [→Current Song]):
This operation deletes the currently-selected song. If there are songs following the deleted song, their song numbers will be moved forward accordingly. Following the delete operation, the next song will be selected.

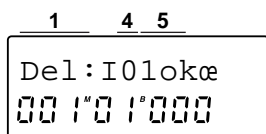

Mov (Move Song [Current Song→Current Drive: Dest Song]):
This operation moves the currently selected song to the specified song number within the same drive. Songs before and after the move destination number will have their numbers moved forward or backward as appropriate.

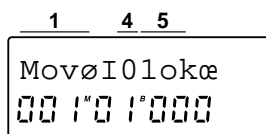

Recov (Recover Song [Current Song→Current Drive: Current Song+1, Original→Current Song])
This operation restores the current song to the state in which it was when first selected. At this time, the current state of the song will be copied to the next song number. The copy destination number and subsequent numbers will be incremented by one. If 50 songs already exist, you will be asked whether it is OK to overwrite the data. Press the [▶] key to overwrite.

P2-2 Source drive number display (only for Copy Song)
.....[I, A...G]

When **Cpy** (Copy Song) is selected in P2-1, this indicates the currently selected drive.
I: Internal IDE (internal drive), A: SCSI ID 0, B: SCSI ID 1, C: SCSI ID 2, D: SCSI ID 3, E: SCSI ID 4, F: SCSI ID 5, G: SCSI ID 6

P2-3 Source song number select (only for Copy Song)
.....[01...50, 1-**]

Selects the copy source song. Select one or all existing songs from the currently selected drive.
01...50: Copy 1 song.
1-** (**: number of last song): All songs in the drive will be copied.

P2-4 Destination drive number select (Copy Song, Rename Song)/display (Delete Song, Move Song, Recover Song).....[I, A...G]

If **Cpy** (Copy Song) or **Renam** (Rename Song) was selected for P2-1, you can select the editing destination drive number.

I: Internal IDE (internal drive), A: SCSI ID 0, B: SCSI ID 1, C: SCSI ID 2, D: SCSI ID 3, E: SCSI ID 4, F: SCSI ID 5, G: SCSI ID 6

If you selected **Del** (Delete Song), **Mov** (Move Song) or **Recov** (Recover Song) in P2-1, the currently selected drive will automatically be displayed.

P2-5 Destination song number select (Copy Song, Rename Song, Move Song)/display (Delete Song, Recover Song)..... [(01...50)]

If you selected **Mov** (Move Song) in P2-1, you can select an existing song in the destination drive.

If you selected **Cpy** (Copy Song) or **Renam** (Rename Song) in P2-1, you can select either an existing song in the destination drive or a New song. However when **Cpy** is selected, if you have selected all songs as the source song setting of P2-3, the numbers shown in the display will be the number which follows the last song in the destination drive, and the last number that is to be copied.

⚠ A maximum of 50 songs can be created in one drive. This means that the number of Source Songs and the number indicated as the last song must total no more than 50. If this number would exceed 50, an error message will appear and the copy operation will not be executed.

The following display shows an example in which songs 1-35 of the internal drive are being copied to SCSI drive B, and the copy destination already contains songs 1-5. In this case, the display indicates that the data will be copied to songs 6-40.

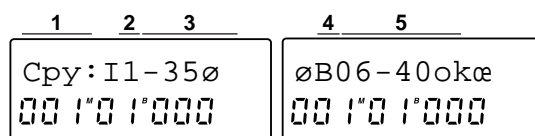

If you selected **Del** (Delete Song) or **Recov** (Recover Song) in P2-1, the currently selected song number will automatically be displayed.

P2-6 Specify the song name (only for Recover Song).
[(blank), A...Z, a...z, 0...9, @, !, ", #, \$, %, ', (,), *, +, -, ., /, :, ;, <, =, >, ?, [, \,], ^, _ {, |, }]

If **Renam** (Rename Song) was selected in P2-1, you can specify the song name. Up to 16 characters can be input.

P3 Edit Track

The area that will be affected by the editing operation can be specified in "15. IN/LOC1, OUT/LOC2, TO/LOC3". (Refer to p.55)

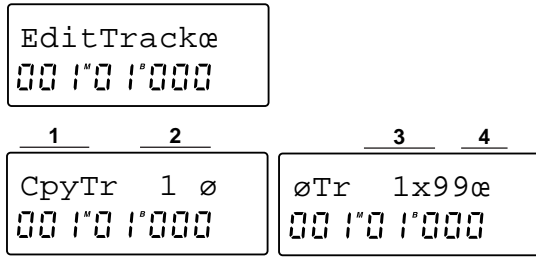

P3-1 Select the type of track editing [CpyTr, Ins, Ers, Del, SwpTr]

Selects the track editing operation that you wish to execute. From the "Edit Track" display, press the [▶] key, and then press the [SONG/TRACK] key to make your selection.

CpyTr (Copy Track [SourceTrack→DestTrack, Times]): This operation will copy the Source track data specified by the IN-OUT settings to the TO location of the Destination track, for the specified number of times.

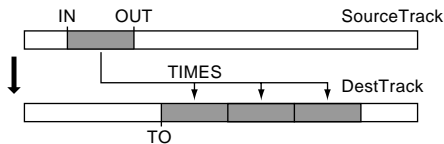

Ins (Blank Insert Track [→DestTrack]):

This operation will insert a blank space into the IN-OUT area of the destination track. Data following the IN location will be pushed forward by the IN-OUT length.

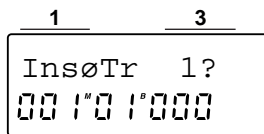
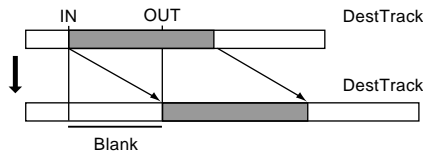

Ers (Erase Track [→DestTrack]):

This operation erases the IN-OUT area of the destination track. The IN-OUT area will be blank.

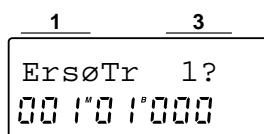
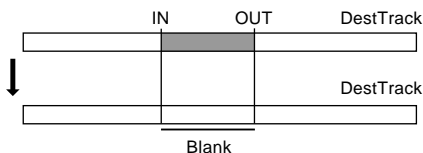

Del (Delete Track [→DestTrack]):

This operation deletes the IN-OUT area of the destination track. Data following the OUT location will be pulled backward by the IN-OUT length.

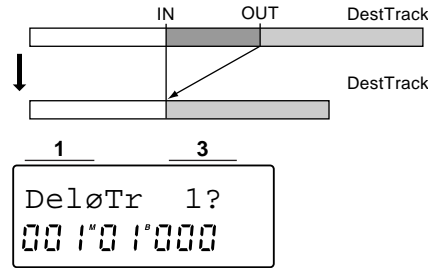

SwpTr (SwapTrack←→DestTrack):

This operation exchanges the data in the IN-OUT areas of the source track and destination track.

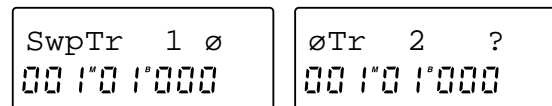
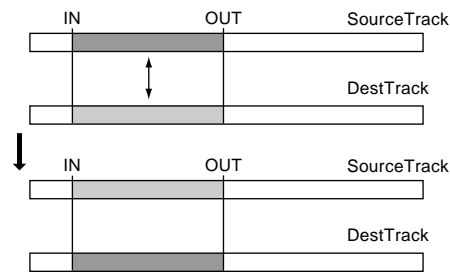

P3-2 Source track select (Copy Track and Swap Track) [1, 2, 3, 4, 5, 6, 7, 8, 1-2, 3-4, 5-6, 7-8, 1-4, 5-8, 1-8, CLP* (Copy Track only)]:

This will appear when **CpyTr** or **Swp** is selected in P3-1. Select the source track for editing.

CLP* (* indicates the number of tracks which the clipboard contains) will appear only when **CpyTr** is selected (refer to P3-3).

P3-3 Destination track select.....[1, 2, 3, 4, 5, 6, 7, 8, 1-2, 3-4, 5-6, 7-8, 1-4, 5-8, 1-8, CLP (Copy Track only)]:

Selects the editing destination track.

CLP (Clip Board) will appear only when **CpyTr** is selected. This is useful when you wish to copy data to the tracks of another song, or to make frequent copies of some particular data. To copy data to the clipboard, select the desired copy source track(s) (1-1-8) in P3-2, and select **CLP** in P3-3. To copy data from the clipboard to the track(s), select **CLP** in P3-2, and select the copy destination track(s) (1-1-8) in P3-3.

The data in the clipboard will be lost the next time you copy data to the clipboard, or when the power is turned off.

⚠ If the number of tracks being copied does not match the number of destination tracks, the copy cannot be performed. (Examples: 3→5-6 or 1-8→4, etc.)

P3-4 Specify the number of copies (Copy Track only)[1...99]

Specifies the number of times that the data in the IN-OUT area of the source track will be copied to the TO location of the destination track.

3. SYSTEM

P1 Channel level meter display selection

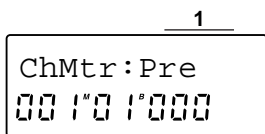

P1-1 Channel level meter display selection..[Pre, Post]

Selects the location at which the channel level meter will display the volume level. These are the levels for channels 1-8.

Pre: The volume level before the EQ and fader of each channel will be displayed.

When inputting external audio sources, this lets you check the [TRIM] settings. During playback this lets you check whether or not each track contains audio.

Post: The volume level after the EQ and fader of each channel will be displayed.

This lets you view the volume level that is being output during playback, or the recording level for each track during recording.

P2 Effect level meter display selection

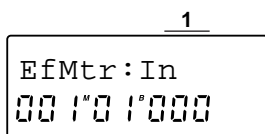

P2-1 Effect level meter display selection.....[In, Out]

Selects the location at which the channel level meter will display the volume level.

In: The input volume level to the effect will be shown. This lets you check the input level to the effect.

Out: The output volume level from the effect will be shown.

This lets you check the output level from the effect.

If the input is stereo or if multiple outputs are used, the louder of the L/R levels will be displayed.

P3 Input monitor selection

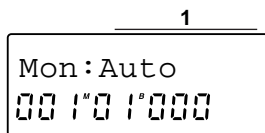

P3-1 Input monitor selection [Auto, Source]

Specifies how the input monitor sound will be output.

Auto: For channels whose [TRACK STATUS] is **REC**, the track playback will be heard during playback, and the external input will be heard during recording (rehearsal) and when stopped.

However if [REC SELECT] is set to **MASTER**, you will always hear the playback tracks.

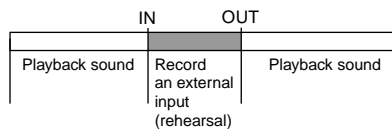

Source: For channels whose [TRACK STATUS] is **REC**, the external input will always be heard.

P4 Foot switch operating mode selection

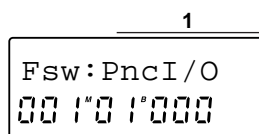

P4-1 Foot switch operating mode selection [PncI/O, PlyStp, Mark]

Selects the function of the foot switch.

PncI/O (Punch In/Out): The foot switch will start and stop manual punch in/out recording.

Set [TRACK STATUS] to **REC** for the track that you wish to record, and then begin playback. The moment you press the foot switch, recording will begin. Recording will end when you press the foot switch again.

PlyStp (Play/Stop): The foot switch will start and stop playback. Pressing the foot switch will start playback, and pressing it again will stop playback.

Mark: Stores a mark.

A mark will be stored when you press the foot switch.

⚠ When Tap Recording (refer to EDIT TEMPO P2) has begun, the foot switch will function as the tap marker regardless of the SYSTEM P4 setting.

P5 Foot switch polarity setting

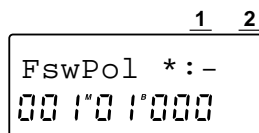

P5-1 Foot switch polarity indicator(*, (Off))

P5-2 Foot switch polarity setting [-, +]

This sets the polarity of the foot switch.

Adjust the setting so that the "*" appears when you press the foot switch.

4. EDIT SYSTEM

P1 Deleting a mark

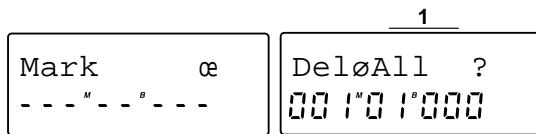

P1-1 Select the mark to be deleted.....[All, 001...100]

Selects the mark that you wish to delete. After making your selection, hold down the [▶] key for approximately 1 second to delete the selected mark.

All: All marks will be deleted.

001...100: The mark of the specified number will be deleted.

P2 MIDI/SYNC settings

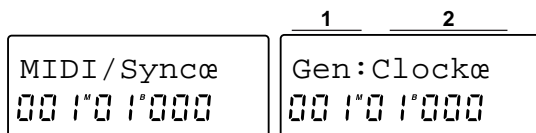

P2-1 Synchronization signal selection..... [Gen, RcvMMC, DevID]

Selects the type of synchronization parameter. When "MIDI/Sync" is displayed, press the [▶] key and then press the [SYSTEM] key to make the selection.

Gen (Sync Generate from MIDI): Synchronization messages will be transmitted from MIDI OUT. In P2-2 you can select the type of messages that will be transmitted.

RcvMMC (Receive MMC): Select this when you wish to receive MMC (MIDI Machine Control) messages from MIDI IN. In P2-3 you can switch reception on/off, and in P2-4 you can specify the Device ID.

DevID (Device ID): Specify the Device ID that will be used for MMC. In P2-4 you can specify the Device ID which will be used when receiving MMC from an external device.

P2-2 Sync Generate settings[Clock, MTC30, Off]

This setting can be changed if you selected **Gen** in P2-1.

Clock: MIDI Clock messages will be transmitted from MIDI OUT.

MTC30: MTC30NDF (MIDI Time Code 30 non-drop format) messages will be transmitted from MIDI OUT.

Off: Synchronization messages will not be transmitted from MIDI OUT.

P2-3 MMC reception on/off[0, -]

This setting can be changed if you selected **RcvMMC** in P2-1.

0 (On): MMC will be received from MIDI IN. Set the Device ID in P2-4.

- (Off): MMC will not be received from MIDI IN.

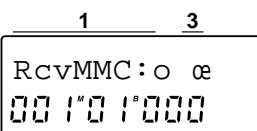

P2-4 Device ID setting[01...32]

If you selected **DevID** in P2-1, this parameter specifies the Device ID that will be used when receiving MMC from an external device.

If you selected **RcvMMC** in P2-1 and selected **0** (On) in P2-3, MMC messages will be received from an external device if the Device ID settings of the two devices match.

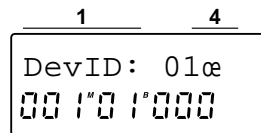

P3 Channel pair enable setting

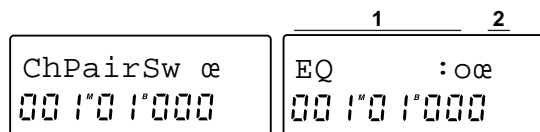

P3-1 Pair enable selection.....[Pan, Snd/Aux, EQ]

P3-2 Pair enable on/off[0, -]

For pan, effect send/aux send and EQ, you can specify whether or not to enable pairing when the Pairing setting is On. (Refer to "26. PAIR On/Off", p.60) With a setting of **0** (On), pairing will be valid. When "ChPair Sw" is displayed, press the [▶] key, and then press the [SYSTEM] key to access the function that was selected in P3-1, and turn it on/off in P3-2. The selected setting will be common to channels 1-6. It is not possible to adjust settings independently for each channel.

Pairing for [Channel] faders and [TRACK STATUS] subject to pairing will be enabled automatically when Pairing is ON.

P4 INPUT 1/2 assign

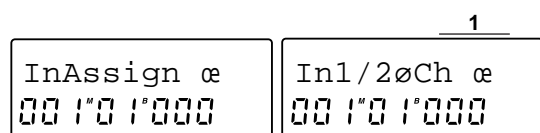

P4-1 INPUT 1/2 assign.....[Ch, Mst]

Specifies the input destination of the audio signals from the INPUT 1/2 jacks.

Ch (Channel): They will be input to mixer channels. Normally you will use this setting.

Mst (Master): They will be input to the master bus. Use this setting when you are cascading the output from another mixer, or when you wish to combine an external sound source with the playback of the eight tracks during mixdown, etc.

P5 Drive information/song backup/ restore/ initialize/format

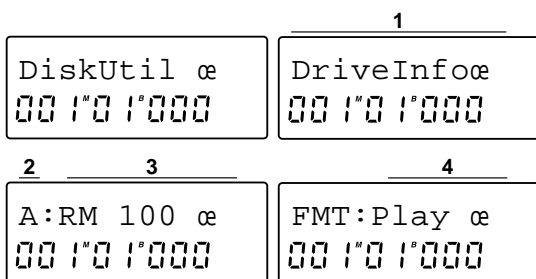

P5-1 Disk utility menu..... [DriveInfo, Backup, Restore, Initial, Format]

DriveInfo: Displays format information for the specified drive.
Backup: Backs up (saves) a song to external media.
Restore: Restores (recall) a song from external media.
Initial: Initializes the specified drive.
Format: Physically formats the specified drive.

Drive information

This is displayed when you select DriveInfo in P5-1.

P5-2 Destination drive select.....[I, A...G]

Selects the drive whose format you wish to check.
I: Internal IDE (internal drive), **A:** SCSI ID 0, **B:** SCSI ID 1, **C:** SCSI ID 2, **D:** SCSI ID 3, **E:** SCSI ID 4, **F:** SCSI ID 5, **G:** SCSI ID 6

P5-3 Destination drive display [HD...RM]

This indicates the type of drive.
HD: Hard Disk, **RM:** Removable Disk

P5-4 Drive format display [Play, Bkup]

This indicates whether the format of the drive selected in P5-2 is for creating songs (**Play**) or for backup (**Bkup**).

Song backup

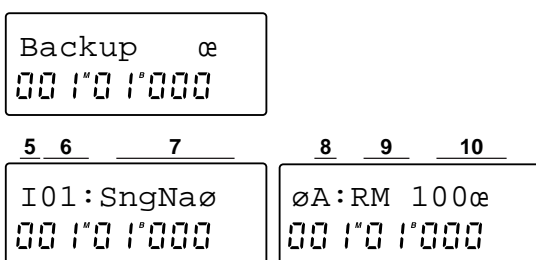

This will be displayed when you select **Backup** in P5-1. This operation will backup (save) one song or all songs from the currently selected drive.

As backup media, you can use either a removable disk of up to 4 Gbytes, or a DAT tape of up to 120 minutes. In the case of a removable disk, you can perform a backup that extends across two or more disks of the same capacity (i.e., multi-volume backups are supported).

In the case of a DAT tape, only one tape can be used for backup.

Be aware that when a backup is performed, the data will be written onto the backup destination drive or DAT, all data which previously existed on the backup destination will be lost.

It is not possible to backup to a hard disk. If you wish to save a song on a different hard disk, use the Song Copy operation. (Refer to "2. EDIT SONG/TRACKP2", p.44)

P5-5 Source disk number display [I, A...G]

This indicates the currently selected drive number.
I: Internal IDE (internal drive), **A:** SCSI ID 0, **B:** SCSI ID 1, **C:** SCSI ID 2, **D:** SCSI ID 3, **E:** SCSI ID 4, **F:** SCSI ID 5, **G:** SCSI ID 6

P5-6 Source song number select..... [01...50, **]

01...50: The specified single song in the currently selected drive will be backed up.
**** (All):** All songs in the currently selected drive will be backed up.

P5-7 Source song name display..... (song name/All)

This displays the name of the song that will be backed up.
 If 01-50 was selected in P5-6, the name of that song will be displayed. If ** was selected, the display will indicate "All".

P5-8 Destination drive/DAT select [A...G, H]

Selects the backup destination removable disk drive or DAT.
A: SCSI ID 0, **B:** SCSI ID 1, **C:** SCSI ID 2, **D:** SCSI ID 3, **E:** SCSI ID 4, **F:** SCSI ID 5, **G:** SCSI ID 6, **H:** DAT

The operation cannot be executed if the hard disk drive is selected.

P5-9 Destination drive/DAT type display..... (RM, DAT)

P5-10 Destination drive/DAT capacity display..... (disk capacity/tape length)

When P5-9 is RM, this shows the formatted capacity (bytes). When DAT is selected, this shows the length (minutes) of the tape that will be required for backup.

P5-11 Destination drive required number of media display [0...99 (only for RM)]

This will be displayed when a removable disk is selected in P5-8.

When backing up to a removable disk, this indicates the number of disks that will be required for the backup. Prepare the appropriate number of disks equal to the capacity of the disk that is currently inserted in the destination drive.

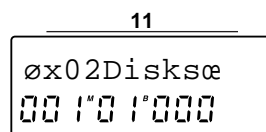

Song restore

This will be displayed if you select **Restore** in P4-1.

This operation restores (recalls) the song that was backed up.

You can select either a removable disk (or disks) or a DAT (multiple volumes are not supported).

If a backup of all songs was performed to a removable disk, you can choose whether to restore all songs or only a specified song.

If a backup of all songs was performed to DAT, it is only possible to restore all songs.

 Be aware that when you perform a Restore of all songs, the data will be written to the restore destination drive, and all data that was previously in the restore destination drive will be lost.

12	13	14
Restore æ 00 1'0 1'000	A:RM 100 ø 00 1'0 1'000	
15	16	17 18 19
A01:SngN ø 00 1'0 1'000	øB02:NoDA 00 1'0 1'000	

P5-12 Source drive/DAT select..... [A...G, H]

Selects the restore source: a removable disk drive or DAT.

 Since Restore can be done only from a **RM** (removable disk) or **DAT**, this operation cannot be executed when a hard disk is selected.

A: SCSI ID 0, B: SCSI ID 1, C: SCSI ID 2, D: SCSI ID 3, E: SCSI ID 4, F: SCSI ID 5, G: SCSI ID 6, H: DAT

P5-13 Source drive/DAT type display..... (RM, DAT)

P5-14 Source drive capacity display..... (disk capacity/no display)

When P5-13 is **RM** this will indicate the formatted capacity (bytes). For **DAT**, nothing will be displayed.

P5-15 Source song number select..... [01...50, All]

Selects the song(s) which will be restored from the source drive or DAT.

When **01...50** is selected, the selected song will be restored.

When **All** is selected, all songs will be restored.

If only one song was backed up, only 01 can be selected.

When restoring an "all song" backup from DAT, All is the only valid selection. If you select an individual song number, your selection will be ignored.

P5-16 Source song name display (four characters displayed)

P5-17 Destination drive select..... [I...G]

Selects the restore destination drive.

I: Internal IDE (internal drive), A: SCSI ID 0, B: SCSI ID 1, C: SCSI ID 2, D: SCSI ID 3, E: SCSI ID 4, F: SCSI ID 5, G: SCSI ID 6

P5-18 Destination song number select [01...50]

When restoring an individual song (i.e., if **01...50** was selected in P5-15), you can select the song number into which the data will be restored.

The data will be restored into the number that you specify, and songs following this restore destination number will be renumbered upward.

P5-19 Destination song name display (four characters displayed)

This will be displayed only when restoring an individual song (i.e., if **01...50** was selected in P5-15).

20	21
øB:HD1300æ 00 1'0 1'000	

P5-20 Destination drive type display..... (HD, RM)

The formatted capacity (bytes) of the disk will be displayed only when performing an "all song restore" (**All** is selected in P5-19).

HD: Hard Disk, **RM:** Removable Disk

P5-21 Destination drive capacity display.. (disk capacity)

Initialize/format

22	23
Initial æ 00 1'0 1'000	A:RM 100 æ 00 1'0 1'000

This will be displayed if you select **Initial** or **Format** in P5-1.

Perform this operation for a newly-purchased drive. You must perform this operation on a drive which was previously used by another device before that drive can be used with the D8, or on a drive which frequently produces Disk Error indications during playback, etc.

P5-22 Destination drive select..... [I, A...G]

Selects the drive that you wish to initialize or format.

I: Internal IDE (internal drive), A: SCSI ID 0, B: SCSI ID 1, C: SCSI ID 2, D: SCSI ID 3, E: SCSI ID 4, F: SCSI ID 5, G: SCSI ID 6

P5-23 Destination drive type display..... (HD, RM)

This indicates the type of drive.

HD: Hard Disk, **RM:** Removable Disk

5. DISPLAY MODE

P1 Counter display selection

P1 Location counter display selection
[MBT, MSM, MSF, FreeTime]

Selects the way in which the location counter will be displayed.
The display will change each time you press the [DISPLAY MODE] key.

MBT (Measure/Beat/Tick [1/96th of a beat]/Mark*):
The location will be displayed in units of a measure from the beginning of the song.
The tempo and time signature for display are specified by TEMPO P1.

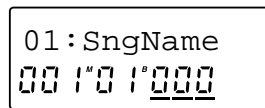

MSM (Minutes/Seconds/Milliseconds/Mark*): The absolute time from the beginning of the song will be displayed.

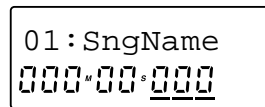

MSF (Minutes/Seconds/Frames [1/30th of a second]/Mark*): The absolute time from the beginning of the song will be displayed. (For MTC synchronization)

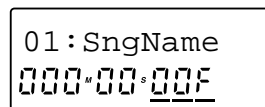

FreeTime (Minutes/Seconds): The remaining time available for recording in the currently selected drive will be displayed. Normally, this indicates the available time for monaural recording (one track). If you set two [TRACK STATUS] indicators to REC, the available time for stereo recording or simultaneous two-track recording will be displayed.

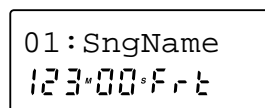

* "Mark" is when the cursor is displayed under the entire location counter. At this time, you can rotate the [VALUE] dial to move to a mark point that you have registered. (Refer to "Moving to a Mark point" p.24)

The counter display will change as follows only during **program playback** (refer to "EDIT PLAY MODE P3").

- Remaining song time
(Minutes/Seconds Millisecond [1/1000th of a second])
- Elapsed song time
(Minutes/Seconds Millisecond [1/1000th of a second])
- Total remaining playback time
(Minutes/Seconds Millisecond [1/1000th of a second])
- Total elapsed playback time
(Minutes/Seconds Millisecond [1/1000th of a second])

6. REC MODE

Recording method select.....
[Off, AutoPunch+RehearsalOn, AutoPunchOn, RehearsalOn]

Selects the recording method. The setting will alternate each time you press the [REC MODE] key.

Off (indicator off): Normal recording.



AutoPunch+Rehearsal (both indicators lit): Rehearsal for Auto Punch In/Out recording will occur in the IN (LOC1)-OUT (LOC2) area for tracks whose [TRACK STATUS] is **REC**.



AutoPunch (indicator lit): Auto Punch In/Out recording will occur in the IN (LOC1)-OUT (LOC2) area for tracks whose [TRACK STATUS] is **REC**.



Rehearsal (indicator lit): Rehearsal* for recording will occur for tracks whose [TRACK STATUS] is **REC**.



* When **AutoPunch+Rehearsal** or **Rehearsal** are selected, when you begin recording, the input monitor system (refer to SYSTEM P2) will operate in the same way as when recording, allowing you to rehearse the recording. Sound will not actually be recorded.

7. PLAY MODE

Playback method select.....
[Off, AutoPlayOn, AutoRepeatOn]

Selects the playback method. The setting will alternate each time you press the [PLAY MODE] key.

Off: Normal playback.

AutoPlayOn: Playback will occur between IN (LOC1) and OUT (LOC2)*, and will automatically stop at the OUT location. You can also stop playback by pressing the [STOP] key.



AutoRepeatOn: Playback will occur repeatedly between IN (LOC1) and OUT (LOC2)*. You can also stop playback by pressing the [STOP] key.



* If you perform Auto Punch In/Out when **AutoPlayOn** or **AutoRepeatOn** is selected, a "pre roll time" will be added before the IN location, and a "post roll time" will be added after the OUT location. (Refer to EDIT PLAY MODE P1, P2.)
For details on setting the IN and OUT locations, refer to "Storing a Locate point" (p.23).

8. EDIT PLAY MODE

P1 Pre roll time setting

Here you can specify the pre roll time that is added to the IN time of Auto Play On and Auto Repeat On when Auto Punch In/Out is performed.

When Auto Play On or Auto Repeat On is used in conjunction with Auto Punch In/Out, you will be able to listen for the pre roll time before punch in occurs, allowing you to prepare to start recording.

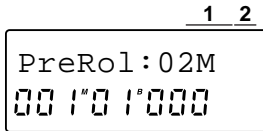

P1-1 Pre roll time numerical setting [00...10]

P1-2 Pre roll time unit select..... [M, s]

Specifies the pre roll time in either measures or seconds.

In P1-1 you can specify a numerical value (00-10), and in P1-2 you can select either **M** (measure) or **s** (second) units. When you change the pre roll time unit, the post roll time unit will change automatically. When **M** is selected, the maximum pre roll time is 10 measures. When **s** is selected, the maximum is 10 seconds.

⚡ When the power is turned on, the pre roll time and post roll time are automatically set to 02M.

P2 Post roll time setting

Here you can specify the post roll time that will be added to the OUT time for Auto Play On and Auto Repeat On when Auto Punch In/Out is performed.

When Auto Play On or Auto Repeat On is used in conjunction with Auto Punch In/Out, you will be able to listen for the post roll time after punch out occurs, allowing you to verify the connection following the recording.

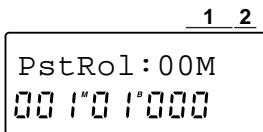

P2-1 Post roll time numerical setting.....[00...10]

P2-2 Post roll time unit select [M, s]

Specifies the post roll time in either measures or seconds.

In P2-1 you can specify a numerical value (00-10), and in P2-2 you can select either **M** (measure) or **s** (second) units. When you change the post roll time unit, the pre roll time unit will change automatically. When **M** is selected, the maximum post roll time is 10 measures. When **s** is selected, the maximum is 10 seconds.

⚡ When the power is turned on, the pre roll time and post roll time are automatically set to 02M.

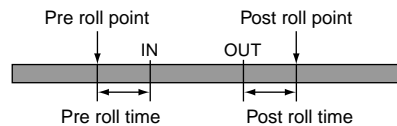

P3 Program play

Up to 50 songs can be played back in a specified order. Program Play will function only while you are in this page.

When the audio data of each song reaches silence, playback will proceed to the next song.

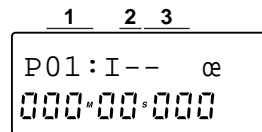

P3-1 Program playback order select..... [01...50]

Selects the order (step) of program song playback. The specified song will playback for each step, from low to high numbered steps. Steps for which no song is specified in P3-3 or steps for which the drive specified in P3-2 and P3-3 was not found will be skipped.

P3-2 Playback drive select..... [I, A...G]

I: Internal IDE (internal drive), A: SCSI ID 0, B: SCSI ID 1, C: SCSI ID 2, D: SCSI ID 3, E: SCSI ID 4, F: SCSI ID 5, G: SCSI ID 6

P3-3 Playback song number select [01...50]

Selects the drive and song number that will playback.

⚡ When you exit this page, the selected order of songs will be reset.

⚡ The location counter display is different only during Program Play. (Refer to "5. Display MODE", p.51)

9. TRIGGER

This function allows the beginning of recording to be triggered by the input signal.

Trigger recording on/off [On, Off]

On (indicator lit): When in record ready mode, an input signal that exceeds the threshold level (refer to EDIT TRIGGER P1) will initiate recording.

Off (indicator off): Recording will begin normally.

⚡ Be aware that when this is **On**, recording will not begin until the threshold level is exceeded. Press the [STOP] key to cancel trigger recording, and readjust the threshold level.

10. EDIT TRIGGER

P1 Threshold level adjustment

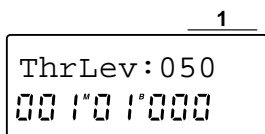

P1-1 Threshold level adjustment [001...100]

When trigger recording is used, this parameter specifies the audio input level that will initiate recording. When in record ready mode, recording will begin when this level is exceeded.

- Since the appropriate level will depend on the source that is being input, try various threshold level settings to find the best setting.

P2 Pre trigger time setting

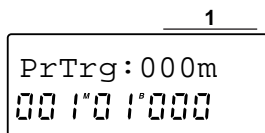

P2-1 Pre trigger time setting [000...700 m (s)]

Specifies the pre trigger time during which the sound will be recorded before the actual trigger time. When trigger recording is used, the initial part of the sound may be lost for sounds with a rapid attack, such as percussion.

By setting the pre trigger time, you can enable the recording to include the low-volume portion that is heard before the trigger threshold level is reached.

Since the appropriate time setting will depend on the source that is being input, try various pre trigger times to find the best setting.

- At the beginning of the song, this will have no effect.
- If you begin recording at the end of a previously recorded track, setting the pre trigger time to other than 000 ms will cause the recording to overlap part of the previously recorded sound, causing the end of that sound to be cut off.

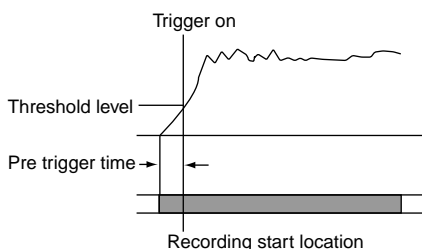

11. TEMPO

P1 Tempo map settings

Specifies the tempo and time signature of the song.

If you wish to listen to the metronome sound while you set the tempo, turn on the metronome (refer to METRONOME) before entering this page.

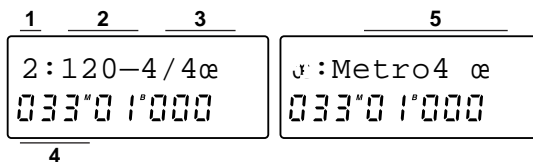

P1-1 Tempo map number select [0...9]

Selects the tempo map number

0: This is the basic tempo map placed at the beginning of the song. It is not possible to specify the location (P1-4) for this.

1...9: These are tempo maps which can be placed elsewhere than the beginning of the song. Select these when you wish to change the tempo or time signature in the middle of a song.

P1-2 Tempo setting [40...240, (Trk)]

Specifies a song tempo of q = 40–240.

This parameter can be set if **Map** has been selected as the tempo source (refer to EDIT TEMPO P1).

If **Trk** has been selected as the tempo source, this page will indicate **Trk**, and it will not be possible to specify the tempo. In this case, playback (recording) will occur at the tempo which was recorded during tempo recording (refer to EDIT TEMPO P2).

- If you modify the tempo after recording, the measures and time signature shown in the location counter will no longer match the audio in the tracks. In order to bring these back into correspondence, use Tap Tempo recording (refer to EDIT TEMPO).

P1-3 Time signature setting [1...8/4, 10/4, 1...8/8, 10/8, 12/8, 16/8, 1...8/16, 10/16, 12/16, 16/16]

Specifies the time signature.

P1-4 Map location setting [000 (Delete Map), 001...999 Meas (set in measure units)]

Specifies the location of the tempo map (i.e., the time at which the setting will begin to change). Simultaneously press the [◀] and [▶] keys to move to the location counter.

This cannot be set if the tempo map number (P1-1) is **0**.

000: Select this when you wish to delete the tempo map. Select **000** for the tempo map that you wish to delete, and it will be deleted when you exit this page.

001...999: Specify the location in the range of measure 1–999.

You can move a tempo map regardless of the location of earlier or later tempo maps.

However when you exit P1, tempo map numbers (P1-1) will be automatically renumbered from low to high, starting from the beginning of the song (i.e., based on the time location within the song).

P1-5 Metronome type select..... [refer to "Metronome type list"]

Selects a metronome type suitable for the time signature that you selected in the Time Signature setting (P1-3).
You can change the rhythm pattern by selecting a metronome type in conjunction with changing the tempo and time signature.

P2 Metronome volume setting

P2-1 Metronome volume setting[001...100]

This sets the volume of the metronome.
The value can be changed either from this page or from EDIT METRONOME P1 (refer to p.55).

.....
12. EDIT TEMPO

P1 Tempo source setting

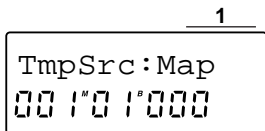

P1-1 Tempo source select [Map, Trk]

Selects the tempo source.
Map: Tempo change will occur according to the tempo map that was created in TEMPO P1.
Trk: Tempo change will occur according to the tempo that was recorded by Tempo Recording (refer to EDIT TEMPO P2).
It is not possible to select **Trk** until you perform tempo recording.
After tempo recording, this will automatically be **Trk**.

P2 Tempo recording

By recording MIDI Clock messages, you can synchronize to the MIDI Clock messages of an external sequencer.
By recording tap tempo, you will be able to use measure units to handle a source of unknown tempo (such as a CD) that has previously been recorded into the D8.
If the time signature changes during the song, you must first use TEMPO P1 to create a tempo map which includes the changes in time signature.
Tempo recording will end automatically when memory becomes full.

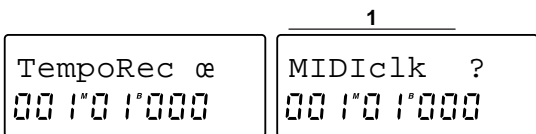

P2-1 Tempo recording source select.....[MIDIClk, MeasTap]

Selects the source for tempo recording.
MIDIClk: MIDI Clock messages from a song recorded on an external sequencer etc. will be recorded to create the tempo track.
MeasTap: Taps at the beginning of each measure will be recorded to create the tempo track. (Refer to p.35)
During tap tempo recording, the foot switch will function as the tap marker, regardless of the SYSTEM P3 setting.
After the tempo track has been created, you can set the tempo source of P1-1 to **Trk** to allow tempo change using the tempo track.

Be aware that if you re-record, the previous tempo track will be erased. Also, since MIDI Clock and Tap are recorded in the same place, only the last-recorded of these two will be valid.

.....
13. METRONOME

Metronome on/off.....[On, Off]

Turns the metronome on/off.
On (indicator lit): The metronome will sound during playback and/or recording (refer to EDIT METRONOME P2), according to the tempo, time signature and metronome type that you specified as the tempo source (refer to EDIT TEMPO P1). The metronome will also sound while you are in TEMPO P1 or EDIT METRONOME P1.
Off (indicator off): The metronome will not sound during playback or recording. Nor will the metronome sound while you are in TEMPO P1 or EDIT METRONOME P1.

The metronome sound is output from OUTPUT L/R and from PHONE. It is not possible to directly record the sound of the metronome.

If you wish to record the sound of the metronome on the D8, use an audio cable to connect the output of the OUTPUT L/R jacks to the INPUT 1/2 jacks, and record as usual. At this time, set the [MASTER] fader to 0.

14. EDIT METRONOME

P1 Metronome volume setting

If the metronome is on (refer to METRONOME), the metronome will sound when you enter this page. You can adjust the volume while listening to the metronome.

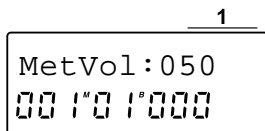

P1-1 Metronome volume setting..... [001...100]

Adjusts the volume of the metronome.

The value can be changed either from this page or from EDIT TEMPO P2. To turn the metronome on/off while you are in this page, press the [EDIT] key and then press the [METRONOME] key to switch it on/off.

P2 Metronome mode setting

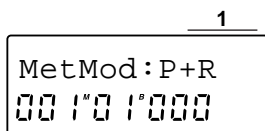

P2-1 Metronome mode setting..... [P+R, Rec, Off]

Specifies when the metronome will be sounded when it is turned on (refer to METRONOME).

P+R (Play+Recording): The metronome will sound during playback and during recording.

Rec (Recording): The metronome will sound during recording.

Off: The metronome will not sound during either playback or recording, regardless of the Metronome On/Off setting.

15. IN/LOC1, OUT/LOC2, TO/LOC3

You can store any desired location in the song to the [IN/LOC1], [OUT/LOC2] and [TO/LOC3] keys, allowing you to move to the specified location (“locate point”) by pressing the appropriate key.

The times that have been stored can also be used for Auto Play/Auto Repeat Playback, as the in/out points for Auto Punch Recording, and as edit points for track editing.

- ◇ To store the current time to a key, press [STORE] and then press the desired [LOC (/IN,OUT,TO)] key.

IN/LOC1

The time location stored to the [IN/LOC1] key will act as follows when the corresponding function is selected.

- Move to locate point 1
- Punch-in time for Auto Punch Recording
- Playback begin time for Auto Play/Auto Repeat Playback
- When performing track editing,
 - starting time for the copy source in Copy Track
 - starting time for the inserted blank in Blank Insert Track
 - starting time for the erased area in Erase Track
 - starting time for the deleted area in Delete Track
 - starting time for the swap source/destination in Swap Track

OUT/LOC2

The time location stored to the [OUT/LOC2] key will act as follows when the corresponding function is selected.

- Move to locate point 2
- Punch-out time for Auto Punch Recording
- Playback end time for Auto Play/Auto Repeat Playback
- When performing track editing,
 - ending time for the copy source in Copy Track
 - ending time for the inserted blank in Blank Insert Track
 - ending time for the erased area in Erase Track
 - ending time for the deleted area in Delete Track
 - ending time for the swap source/destination in Swap Track

TO/LOC3.....

The time location stored to the [TO/LOC3] key will act as follows for when the corresponding function is selected.

- Move to locate point 3
- When performing track editing,
 - location to which data will be copied by Copy Track

16. SCENE

Mixer settings can be stored at a desired location in a song.

A set of mixer settings that has been stored in this way is called a "scene". Up to twenty scenes can be stored in each song.

The following mixer settings are included in a scene: high EQ "HEQ", low EQ "LEQ", effect send "Snd", AUX send "Aux", pan (the [PAN], [BALANCE] knob) and the channel volume level (the [CHANNEL] fader).

- ◇ To store the mixer settings in the current scene, press [STORE] and then press the [SCENE] key. At this time, the display will indicate the scene number that is being stored.

Scene Read on/off [On, Off]

On (indicator lit): Scenes will be read. As playback continues, settings will change at the registered times.

Off (indicator off): Scenes will not be read.

It is possible to store mixer settings without regard to a specific time location, and recall them as general-purpose setups.

- ⚠ If no scenes have been stored, it will not be possible to turn this **On**.

When Scene Read is **On**, the settings of the [PAN] knobs and the [CHANNEL] faders will not match the physical locations of the front panel controls.

Mixer parameter values can be adjusted even when Scene Read is **On**.

When you change this setting from **Off** to **On**, the scene that is stored for that time location will be read. For example if this is switched from **Off** to **On** between the time locations of scene 1 and scene 2, scene 1 will be loaded.

When you change this setting from **On** to **Off**, the parameter values that were in effect at that time will be maintained. Even if a mixer parameter value is modified while this is **On**, the modified value will be maintained.

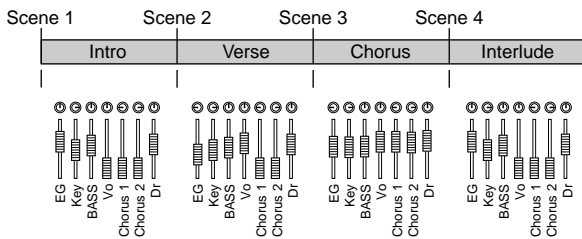

* The faders and pan knobs do not actually move.

17. EDIT SCENE

P1 Scene parameter list

The various mixer settings that were stored in a scene (refer to SCENE) are displayed in the level meter section.

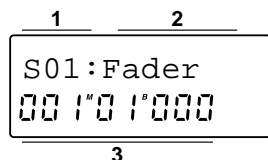

P1-1 Scene number select.....[S01...20, CUR, -1]

Selects the number of the scene whose settings you wish to check.

When Scene Read is On

The scene for the current time location will automatically be selected. Use this to check the current scene.

S01...20: The level meter section will indicate the settings of the scene for the current time location. You will be able to select only the one scene for the current time location.

CUR (Current): The level meter section will indicate the current settings of the mixer section. If you have modified the mixer settings after the scene has changed, this lets you see the actual settings.

- -: This will be displayed when there is no scene for the current time location.

When Scene Read is Off

In this case you can select a scene without regard to the current time location. Use this when you wish to check the setting memory or various scenes.

S01...20: The level meter section will indicate the settings of the selected scene, and that scene will be recalled. The current audio output will be changed according to these settings.

The first-displayed scene number will be the scene number which was the basis for the current settings of the mixer (i.e., the most recently recalled scene).

- -: This will be displayed when no scene has yet been recalled.

If you modify the mixer settings after a scene has been selected, the ":" beside the scene number will change to "*" to indicate that the current values are different than those of the selected scene.

- ⚠ Scene recall will not be performed for mixer channels whose tracks are set to [TRACK STATUS] REC.

P1-2 Scene display parameter select..... [Fader, Pan, Snd, Aux, HiEQ, LoEQ]

Selects the parameter of the scene selected in P1-1 which will be indicated by the level meters.

P1-3 Scene start location display.....

This displays the time location at which the scene selected in P1-1 will be recalled. The location will be shown in the units selected for Location Counter Display Mode (refer to DISPLAY MODE).

If no scene has been stored, the display will indicate "--".

P2 Deleting a scene

This operation deletes one scene or all scenes.

- ◇ In P2-1, select the scene that you wish to delete, and press and hold the [▶] key for approximately 1 second to delete that scene.

Scenes cannot be deleted if Scene Read is ON.

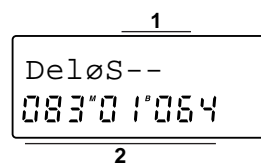

P2-1 Select the scene number for deletion.....[S01...20, All]

Selects the number of the scene that you wish to delete.

S01...20: The selected scene will be deleted.
All: All scenes in the currently selected song will be deleted.

It is not possible to delete an empty scene “- -”.

P2-2 Scene start location display

This displays the location at which the scene will be recalled.

An empty scene is displayed as “- -”.



18. STORE

Use this page when you wish to store a location, mark or scene.

- ◇ Each time you press the [STORE] key, the display will cycle between “Store” → “Mark” → “the page you were in before pressing [STORE]”.

P1 Storing IN/LOC 1, OUT/LOC 2, TO/LOC 3 or a Scene

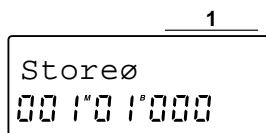

P1-1 IN/LOC 1, OUT/LOC 2, TO/LOC 3, Scene number[In, Out, To/S01...20]

Storing a location to IN/LOC 1, OUT/LOC 2, TO/LOC 3
 Move to the location that you wish to store, and press the [STORE] key to get the “Store” display. Then press the desired key ([IN/LOC 1], [OUT/LOC 2] or [TO/LOC 3]) to store the location.

Storing a scene

Move to the location at which you wish to store the scene, make mixer settings, press the [STORE] key to get the “Store” display, and then press the [SCENE] key to store the scene.

P2 Storing a Mark

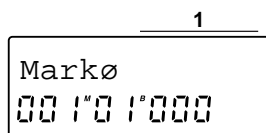

P2-1 Mark number [M001...100]

Storing a mark

Move to the location at which you wish to store a mark, press the [STORE] key twice to get the “Mark” display, and press any key ([IN/LOC 1], [OUT/LOC 2], [TO/LOC 3]) to store the mark.

.....

19. SCRUB

Scrub on/off [On, Off]

Switches the Scrub, Play From and Play To playback functions on/off. You can use these functions when you wish to find the precise location at which a sound begins, etc.

On (indicator lit): Rotating the [VALUE] dial will perform scrub playback. When you press the [PLAY] key, playback will begin from the currently stopped location, and will stop after two seconds of playback. After stopping, the song will automatically return to the location at which playback was started (the Play From function). If you hold down the [STOP] key and press the [PLAY] key, playback will begin from a point 2 seconds earlier than the currently stopped location, and will continue until the location at which you had stopped (the Play To function). Press the [FF] key to begin half-speed playback from the time at which you are currently stopped, and playback will continue until you press the [STOP] key. After stopping, you will automatically return to the location at which playback began (Slow Play function).

During playback, the level meters will indicate the pre-fader volume, regardless of the setting of SYSTEM P1 (refer to p.47). When stopped, the level meters will maintain the volume level of the moment at which playback stopped.

Tracks whose [TRACK STATUS] is **PLAY** or **REC** will playback (REC will change to **PLAY**).

Off (indicator off): Operation will be as normal.

- ⚠ When **On** is selected, the [VALUE] dial will be used for scrub playback, and it will not be possible to use the [VALUE] dial to modify parameter values.

.....

20. UNDO

Undo/Redo[U (Undo), R (Redo), (Off)]

After an operation has been executed, you can **Undo** to restore the condition prior to executing the operation, or **Redo** to go back to the condition prior to Undo.

After you execute recording, an edit track operation (Copy Track, Blank Insert Track, Erase Track, Delete Track, Swap Track), you can use Undo to recover the previous condition.



Undo can be performed when **U** is displayed.

Redo can be performed when **R** is displayed.

- ⚠ Undo/Redo will no longer be available when the power has been turned off or after formatting etc.

21. TRACK STATUS

Track status select
 [PLAY, REC (ANALOG), REC (DIGITAL), Mute]

Selects the status of each track.

- ◇ Each time you press the [TRACK STATUS] key, the function will change and the indicator color will change to show this.

PLAY (indicator lit green): The selected track can be played back.

REC (ANALOG) (indicator blinking/lit red): This can be selected when [REC SELECT] is **INPUT 1/2** or **MASTER**. Audio from the external input jacks INPUT 1/2 or from the master bus can be recorded to the selected track. The indicator will blink during record-ready condition, and will light during recording (or rehearsal).

REC (DIGITAL) (indicator blinking/lit orange): This can be selected when [REC SELECT] is **DIGITAL IN**. The external input from the DIGITAL IN connector can be recorded to the selected track. The indicator will blink during record-ready condition, and will light during recording (or rehearsal).

It is not possible to input from the internal effect or from an external input via the AUX IN jacks.

MUTE (indicator off): The selected track will be muted.

When input monitor (refer to p.47) is set to **AUTO**, setting [TRACK STATUS] to **REC** will cause the EQ and fader to apply only to the input sound, so that the fader and EQ will not affect the playback sound of the track. Be aware that if you inadvertently change the fader or EQ settings during playback etc., the volume or EQ of the input sound will be affected.

However if [REC SELECT] is set to **MASTER**, it will be the same as when [TRACK STATUS] is set to **PLAY**; you will always hear the playback tracks, and faders and EQ will be valid.

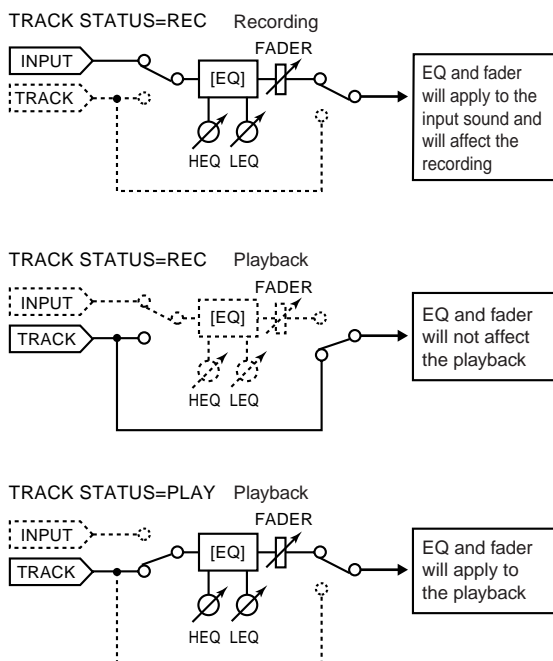

Pairing (refer to PAIR On/Off) is also possible.

22. EQ

P1 High EQ gain adjustment

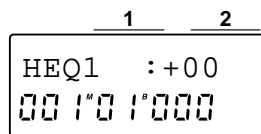

P1-1 Channel number display..... [1, 2, 3, 4, 5, 6, 1-2, 3-4, 5-6, 7-8]

This shows the currently selected channel number. 1-2, 3-4 and 5-6 will appear when Pairing is **On** (refer to PAIR On/Off).

P1-2 HEQ (Fc=10 kHz) gain setting.....[-15...+00...+15]

The boost/cut at the 10 kHz cutoff frequency can be adjusted over a range of -15~+15 dB.

P2 Low EQ gain adjustment

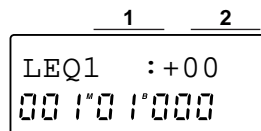

P2-1 Channel number display..... [1, 2, 3, 4, 5, 6, 1-2, 3-4, 5-6, 7-8]

This shows the currently selected channel number. 1-2, 3-4 and 5-6 will appear when Pairing is **On** (refer to PAIR On/Off).

P2-2 LEQ (Fc=100 Hz) gain setting.....[-15...+00...+15]

The boost/cut at the 100 Hz cutoff frequency can be adjusted over a range of -15~+15 dB.

High EQ and Low EQ can be paired (refer to PAIR On/Off), and registered as part of a scene (refer to SCENE).

23. EFFECT SEND

P1 Effect send level (Snd) adjustment

Adjusts the level that is sent from after each channel fader (post fader) to the internal effect.

Adjust this setting when you use the internal effect.

- ⚠ When [REC SELECT] **DIGITAL IN** is selected, the internal effect will be off.

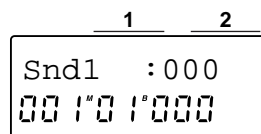

P1-1 Channel number display.....
[1, 2, 3, 4, 5, 6, 1-2, 3-4, 5-6, 7-8]

This shows the currently selected channel number.
1-2, 3-4 and 5-6 will appear when Pairing is **On** (refer to PAIR On/Off).

P1-2 Effect send level settings [000...100, Wet]

Adjusts the send level to the internal effect (refer to EFFECT).

When [EFFECT ASSIGN] is INPUT 1/2

The send bus for all channels will automatically be turned off, and the audio signal from the INPUT 1/2 jacks will be sent to the effect.

When [EFFECT ASSIGN] is MASTER (Send Type)

000-100: Adjust the send level to the master effect.

Wet: All of the audio from the selected channel will be sent to the effect, and the Dry sound will not be sent to the master bus.

When [EFFECT ASSIGN] is MASTER (Global Type)

The send bus of each channel will automatically be turned off, and the sound of the master bus will be sent to the effect.

This setting can be paired (refer to PAIR On/Off) and stored in a scene (refer to SCENE).

P2 External output (Aux) level setting

Adjusts the level that is sent to AUX OUT (external output) from after the channel faders (post fader). Adjust this setting when you are using an external effect device.

 When [REC SELECT] is set to **DIGITAL IN**, and [EFFECT ASSIGN] is set either to **INPUT 1/2** or **MASTER (Global Type)**, it is not possible to use AUX IN (external input).

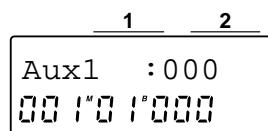

P2-1 Channel number display
[1, 2, 3, 4, 5, 6, 1-2, 3-4, 5-6, 7-8]

This shows the currently selected channel number.
1-2, 3-4 and 5-6 will appear when Pairing is **On** (refer to PAIR On/Off).

P2-2 External output (Aux) send level setting[000...100, Off]

Adjusts the send level to AUX OUT.
This setting can be paired (refer to PAIR On/Off) and stored in a scene (refer to SCENE).

.....
24. PAN/BALANCE

Here you can adjust the pan/balance of the stereo signal sent from each channel to the master bus.

In the case of channels 1-6 for which pairing is **Off** (refer to PAIR On/Off), this will be the pan adjustment to the master bus.

In the case of channels (1-6) for which pairing is **On** and for channels 7/8, this will be the left/right balance adjustment to the master bus.

This setting can be paired (refer to PAIR On/Off) and stored in a scene (refer to SCENE).

.....
25. FADER

Adjusts the volume level.

The recording level is adjusted by the channel faders when recording an external input (when [REC SELECT] is **INPUT 1/2** or **DIGITAL IN**). When recording the master bus during track bouncing etc. ([REC SELECT] is **MASTER**), the recording level is adjusted by the master fader.

[CHANNEL] (1...7/8) faders
(playback/input recording level adjustment)

Adjusts the volume of each track.

For channels whose [TRACK STATUS] is **PLAY**, adjust the playback level.

For channels whose [TRACK STATUS] is **REC**, adjust the input level or recording level of the signals from the INPUT 1/2 jacks or the DIGITAL IN jack.

[MASTER] fader
(master/master recording level adjustment)

Adjusts the volume level of the master bus.

This will determine the output volume of the OUTPUT L/R jacks and the DIGITAL OUT jack.

When [REC SELECT] is **INPUT 1/2** or **DIGITAL IN**, this adjusts the volume level of the master bus.

When [REC SELECT] is **MASTER**, this adjusts the recording level for tracks whose [TRACK STATUS] is set to **REC (ANALOG)**.

26. PAIR On/Off

P1-1 Pairing on/off [On, Off]

Turns pairing on/off for the mixer channels.

Mixer settings of adjacent odd and even numbered channels (1-2, 3-4 and 5-6) can be linked so that changes to the setting of one channel will be simultaneously reflected by the setting of other channel.

The following mixer settings can be pairing. [TRACK STATUS] key, High EQ "HEQ", Low EQ "LEQ", Effect Send "Snd", Aux send "Aux", Balance ([PAN] knobs), and the channel volume level ([CHANNEL] faders).

For each of these parameters except for [TRACK STATUS] and [CHANNEL] fader, you can specify whether or not the parameter will be paired. (Refer to EDIT SYSTEM P3 "Channel pair enable setting".)

- ◇ Pairing can be switched on/off by simultaneously pressing the [EFFECT SEND] keys of the channels that you wish to pair.

"HEQ", "LEQ", "Snd" and "Aux" can be set from either the odd or even numbered channel.

In the case of the [CHANNEL] faders and [BALANCE (PAN)] knobs*, only the odd numbered channel of the pair can be set.

When pairing is **On**, the selected channel number for a setting such as EQ that is included in the pair will be displayed as "-" (e.g., HEQ1-2).

When pairing is **Off**, the selected channel number for settings such as EQ will be displayed normally (e.g., HEQ1).

- * PAN will adjust the pan to the master bus if Pairing is **Off**, or the left/right balance to the master bus if Pairing is **On**.

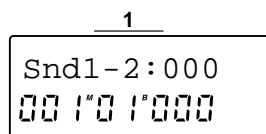

27. REC SELECT

Input/recording source select.....
[INPUT 1/2, INPUT 1/2+MASTER, MASTER, DIGITAL IN]

Selects the source for input and recording.

INPUT 1/2 (indicator lit): Select this when you wish to connect an external device such as a guitar, keyboard or mic to the INPUT 1/2 jacks for normal input or recording.

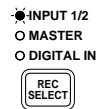

INPUT 1/2+MASTER (both indicators lit): Select this when you wish to record the input from the bus master (bounce), or to record the input from an external device connected to the INPUT 1/2 jacks together with the other tracks.

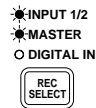

MASTER (indicator lit): Select this when you wish to record the input from the master bus, or when you wish to bounce all the playback sound of all eight tracks.

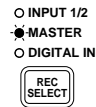

DIGITAL IN (indicator lit): Select this when you wish to record from an external device such as a CD, MD or DAT that is connected to the DIGITAL IN connector. In this case it will not be possible to use the internal effect or an external input from the AUX IN jacks.



28. EFFECT

The D8 contains one multi-effect unit, which provides 130 different effect programs. Of these, 65 are factory presets, and 65 are user area programs (for containing programs which you edit).

Each effect program connects up to 4 types of effect. Such a collection of connected effects is called a "chain".

(Example) The following diagram shows the chain for guitar program no.1 Rock Lead (EG1: ROCK) (refer to the "Effect program list")

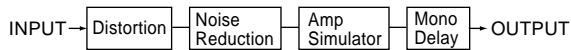

The input and output of an effect program is determined by the effects which make up the chain. Effect types can be broadly divided into three types (refer to "P1-2 Effect name display").

To help you select an appropriate effect, these effect programs are categorized into 11 categories, by the instrument or function for which they are used (refer to "P1-1 Effect category and effect number select").

In addition, you can select one of three locations in which the effect will be placed: **INSERT**, **MASTER (Send Type)** or **MASTER (Global Type)**. (Refer to "EFFECT ASSIGN".)

Separately from the effect program, the D8 provides a monitor delay which lets you apply delay only to the monitor sound. (Refer to "P2 Monitor delay".)

P1 Effect select

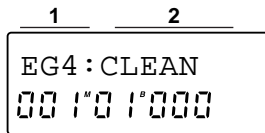

P1-1 Effect program (category number) select..... [RD1...SE9 (Factory Preset), U01...U65 (User Area)]

Selects the effect program.

Following the two character effect category name, the display will show the number within that category, and the effect name (refer to P1-2).

When you edit an effect, the ":" display will change to "*". When you save the effect, this will return to ":". (For editing/saving to the user area, refer to EDIT EFFECT.)

(Example) The screen display shown above

This screen shows a selection of Electric Guitar, number 4, Clean Guitar (mono in/stereo out).

Each effect program of the D8 belongs to one of 11 different categories to distinguish the instrument or function for which they are intended.

Functional categories	Display
Reverb/delay	RD
Modulation	MO
Dynamics	DY
Equalizer	EQ

Instrument categories	Display
Electric guitar	EG
Acoustic guitar	AG
Electric Bass	EB
Vocal	VO
Drums	DR
Keyboard	KB
Special	SE

Functional categories include spatial-type effects and dynamics processing.

These effects are intended mainly for application to the overall mix, such as during mixdown.

When [EFFECT ASSIGN] is set to **MASTER (Global Type)**, selecting EQ will let you use the effect as an overall EQ, or selecting a limiter will let you use the effect as an overall limiter.

The instrument categories provide effects that are suited for their respective instruments. However there may be situations in which interesting results can be obtained by selecting an effect that is intended for a different instrument than what you are actually using, so you need not feel limited by the category.

P1-2 Effect name display..... (C2 ROOM...C2 CnCNL)

The input and output of the effects are structured in one of three ways: "mono-in/stereo-out", "mono-in/mono-out" x 2, or "stereo-in/stereo-out".

For "mono-in/mono-out" x 2 channel and "stereo-in/stereo-out" effects, a "C2" symbol will be displayed at the beginning of the effect name. (Refer to "Effect program list".)

<Mono-in/stereo-out>

These effects are applied to a single channel (or two or more channels that are mixed before the effect input), and output in stereo. If mono output is sufficient, use only one channel of the stereo output.

However, depending on the effect chain, both channels may have the same output even if the effect is stereo out.

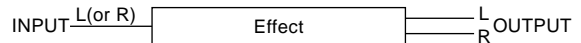

When you select an effect of this type for a stereo source, the signals of both channels will be mixed as shown in the following diagram, and the effect will be applied.

Stereo input to a [Mono-in/stereo-out] type effect

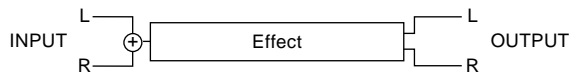

<Mono-in/mono-out> × 2 channels

Use these effects when you wish to apply the same effect simultaneously to two channels.

For example you would select this if you are inputting a piano sound from your keyboard in stereo, and would like to apply a compressor to each channel independently to process the sound that is being recorded.

However, simultaneous two-channel input is accepted only if [EFFECT ASSIGN] is set either to **INPUT 1/2** or **MASTER (Global Type)**.

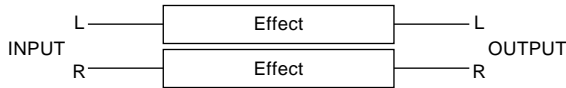

Of course, you are free to input only one of the channels.

If you select this type for a monaural source, the effect will apply only to one channel as shown in the following diagram, and only that single channel will be output.

Mono input to a [Mono-in/mono-out] × 2 channel type effect

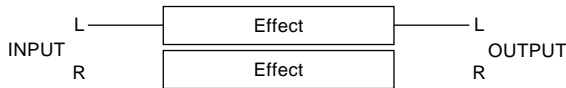

<Stereo-in/stereo-out>

These effects assume that you are using a stereo input source.

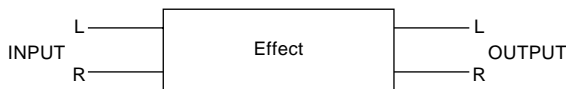

In some cases, inputting a monaural source may fail to produce the desired effect (see the following diagram). An example of this type of effect would be the Center Canceller; the effect will not be produced unless a stereo source is input.

Mono input to a [Stereo-in/stereo-out] type effect

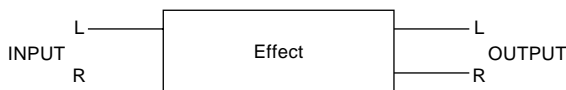

P2 Monitor delay settings

You can apply a delay to only the monitor sound. When recording vocals or guitar, applying delay to the monitor sound will add a sense of spaciousness, making it easier for you to sing or play, and the delay effect will not be applied to the sound that is actually recorded.

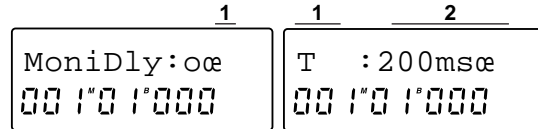

The monitor delay page will appear when [EFFECT ASSIGN] is set to **INPUT 1/2** and [REC SELECT] is set to **INPUT 1/2**.

P2-1 Monitor delay on/off[o (On), - (Off)]

Turns the monitor delay on (o) or off (-).

Monitor delay can be turned on only for tracks whose [TRACK STATUS] is **REC (ANALOG)** when [EFFECT ASSIGN] is set to **INPUT 1/2** and [REC SELECT] is set to **INPUT 1/2**. Monitor delay will be applied only to the sound that is input from the INPUT 1-2 jacks. Monitor delay will not be applied to the playback tracks.

Monitor delay can be turned on as long as the above settings are made, and will still apply even if the entire effect chain is turned off. Also, monitor delay is switched on/off from one location (not for individual channels). When the power is turned off, monitor delay will be OFF the next time the power is turned on.

P2-2 Monitor delay parameter select (refer to "Effect parameter list")

P2-3 Monitor delay parameter settings (refer to "Effect parameter list")

Selects the monitor delay parameters in P2-2, and set their values in P2-3.

The parameters that are set for the monitor delay are saved automatically. However when the power is turned off, they will return to their initial settings.

When the monitor delay page is displayed, you can press the [EDIT] key to access the editing page for the currently selected effect program (refer to "29. EDIT EFFECT"). When you press the [EDIT] key to exit the editing page, you will return to the previous monitor delay page.

29. EDIT EFFECT

P1 Editing and saving an effect

You can edit the effect program that you selected in EFFECT P1. Each program consists of up to four effects.

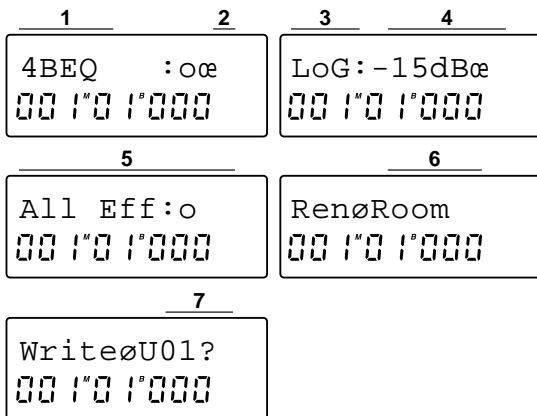

◇ In EDIT EFFECT, repeatedly pressing the [EFFECT] key will cycle the display through the various effects which make up the chain, and will then display All Effects On/Off (P1-5)→Rename (P1-7)→Save (P1-8).

P1-1 Effect select(refer to “Effect program list”)

Selects the various effects which make up the effect program which was selected in EFFECT P1.

P1-2 Effect on/off[0, -]

Switches each effect on (o) or off (-).

P1-3 Effect parameter select.....(refer to “Effect parameter list”)

Selects the effect parameter that you wish to edit.

◇ Press the [▶] key to move to the next parameter, or press the [◀] key to move to the previous parameter. When any parameter is displayed, you can press the [EFFECT] key to move to the P1-1 Effect select page.

P1-4 Effect parameter value

Specifies the value of the effect parameter.

P1-5 Effect program on/off[0, -]

Turn the effect program on (o) or off (-).

The function will depend on the [EFFECT ASSIGN] setting.

[EFFECT ASSIGN]	Effect program OFF	
INPUT 1/2 MASTER (Global Type)	Each effect will be turned off, and the signal will bypass the effects.	
MASTER (Send Type)	“Snd” is 0...100	“EffRet” will be set to 0.
	“Snd” is Wet	Each effect will be turned off, and the signal will bypass the effects.

⚠ Off (-) is valid only within this page. When you move to another page, it will automatically be turned on.

Only the effects which were turned on in P1-2 will be turned off. When you return the setting to on (o), only the effects which were turned on in P1-2 will be turned back on. Also, the Monitor Delay on/off setting will not change.

P1-6 Save destination effect program name..... [(blank), A...Z, a...z, 0...9, @, !, ", #, \$, %, ', (,), *, +, ,, - , , /, : ; , < , = , > , ? , [\] , ^ , _ , { | , }]

Input the name of the effect program that you wish to save.

⚠ If the effect program name contains a œ (a symbol which indicates a stereo input effect), and if you modify this symbol while inputting the name, it will no longer be possible to select it again. If you wish to retain the œ symbol in the name of the effect program to be saved, begin entry following this symbol.

P1-7 Select the user effect number for the save destination

If the editing source is a user effect program U** (** is the number), the same number U** as the writing destination number will be displayed. If the editing source is a preset effect program, number U01 will automatically be displayed as the writing destination number.

Rotate the [VALUE] dial to select the memory number in which the data will be saved, and then press and hold the [▶] key for approximately one second. The display will indicate “Complete” when the data has been saved.

⚠ If you turn the power off or select another effect program, your edits will be lost. If you wish to keep the changes you made, you must save them.

⚠ Since the data will be written over the program which previously occupied the save destination number, that program will be lost.

The user area is used in common by all songs.

30. EFFECT ASSIGN

Effect insert location select[..... INPUT 1/2, MASTER (Send Type), MASTER (Global Type), OFF]

Selects the location at which the internal effect will be inserted.

INPUT 1/2: The internal effect will be inserted between the EQ and the fader of mixer channels whose [TRACK STATUS] is set to **REC (ANALOG)**. (Refer to p.70)

Use this setting when you wish to apply an insertion-type effect during recording.

The “Snd” (refer to “23. EFFECT SEND”) for each channel will automatically be turned off.

MASTER (Send Type): The signals (send bus) which are sent from the “Snd” (refer to EFFECT SEND) of each mixer channel will be sent to the internal effect, and the effect will be inserted as a master effect which outputs to the master bus. (Refer to p.69) Since the signal sent to the effect is monaural, there may be cases in which the desired result will not occur even if a stereo-input type effect is selected.

Use this setting when you wish to apply a master-type effect during playback or recording, or to apply an insertion-type effect to the playback while recording it. The “Snd” (refer to “23. EFFECT SEND”) of each channel is set manually.

MASTER (Global type): The output of the master bus will be sent to the internal effect, and the effect will be inserted as a master effect before the master fader. (Refer to p.70)

Use this setting when you wish to apply an effect such as a stereo compressor etc. to the entire song during mixdown.

The “Snd” (refer to “23. EFFECT SEND”) of each channel is turned off automatically.

OFF: The audio return from the internal effect will be turned off.

The effect return level setting (refer to “EDIT EFFECT ASSIGN P1”) will be ignored.

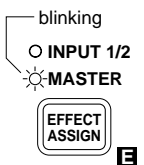
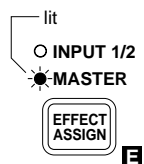

31. EDIT EFFECT ASSIGN

P1 Effect return level setting

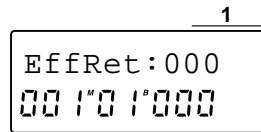

P1-1 Effect return level setting [000...100]

Sets the volume of the signal that is returned from the internal effect.

P2 Effect return balance setting

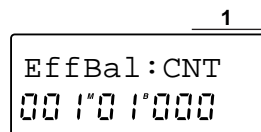

P2-1 Effect return balance setting [L50...CNT...R50]

Sets the left/right balance of the signal that is returned from the internal effect.

P3 External input (AUX IN) level setting

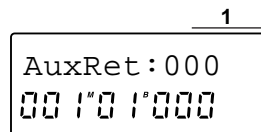

P3-1 External input (AUX IN) level setting [000...100]

Sets the input volume level of the external input (AUX IN).

P4 External input (AUX IN) balance setting

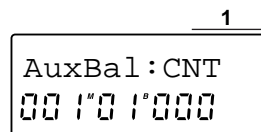

P4-1 External input (AUX IN) balance setting [L50...CNT...R50]

Sets the left/right balance of the signal from the external input (AUX IN).

1. Troubleshooting

■ No sound!

- ↪ Is the power of the D8 and other equipment turned on? (→p.8)
- ↪ Is the [MASTER] fader or [PHONES] knob of the D8 turned down? (→p.2, p.7)
- ↪ Are the channel volume levels of the D8 turned down? If you have used the Scene Read operation, the actual volume levels may not match the fader positions.
- To bring the actual levels into correspondence with the faders, raise and lower the faders.
- ↪ Is the [TRACK STATUS] set to **MUTE**? (→p.58)
- ↪ Are the audio cables connected correctly? (→p.7)
- ↪ Is an audio cable broken?
- ↪ Has the volume of a connected device been lowered? (→p.8)

The input sound cannot be heard, or is too soft

- ↪ Is [TRIM] set appropriately? (→p.10, p.11)
- ↪ Make sure that [TRACK STATUS] is set to **REC.** (→p.10)
- ↪ Make sure that [REC SELECT] matches the input source. (→p.60)
- ↪ If using AUX input, has the “AuxRet” level been set to **0** or near **0**? (→p.64)
- ↪ For playback, has “Monitor” been set to **Auto**? (→p.47)
- ↪ Is the digital input format incorrect?
- Connect an instrument or digital audio device that supports the CP-1201 or S/P DIF formats.

■ Channel faders and EQ do not function!

- ↪ When the [TRACK STATUS] is **REC.**, the EQ and fader will apply only to the input sound, and not to the playback sound.
- If you want the EQ and fader to apply, set the [TRACK STATUS] to **PLAY** for playback.

■ Cannot record!

- ↪ Has the [CHANNEL] fader of the D8 been lowered? (When [REC SELECT] is **INPUT 1/2** or **DIGITAL IN**) (→p.10, p.11)
- ↪ Has the master fader of the D8 been lowered? (When [REC SELECT] is **MASTER**) (→p.17)
- ↪ Make sure that the [TRACK STATUS] of the track you wish to record is set to **REC.** (→p.10, p.11, p.17)
- ↪ Is there insufficient time available for recording on the disk? (→p.51)
- ↪ Has “InAssign” been set appropriately for the source that you are recording? (→p.48)
- ↪ Does [REC SELECT] match the input source? (→p.60)

■ Time available for recording does not match the remaining time!

- ↪ When [DISPLAY MODE] is indicating **FreeTime** (→p.51), the time available for recording that is calculated from the remaining disk capacity may be less than the time that can actually be recorded. This is not a malfunction.
- Normally, **FreeTime** calculates and displays the time that is available for monaural (i.e., single track) record-

ing on the disk drive that is currently being used. To check the time that is available for stereo recording or simultaneous two-track recording, set two [TRACK STATUS] indicators to **REC.**

- When you record over a previously recorded track, the previously recorded data will be saved on disk, meaning that extra disk capacity will be used. If you do not need to keep the previously recorded track, you can save disk capacity by performing the Undo operation before re-recording.
- When you record over a previously recorded track, the disk capacity will be affected as follows. For example, suppose that you recorded a certain track for ten minutes (A-B), and then re-recorded for twelve minutes (A-C) so as to overlay the A-B region. The data initially recorded in the A-B region (approximately 50 MB of data for 10 minutes) will remain even after you record over (overwrite) it, meaning that a total of 22 minutes of capacity (approximately 110 MB) will be occupied. In such cases if you wish to conserve disk capacity, make sure that the HDD access indicator is completely dark, and then turn the power off and back on again. The D8 will automatically erase the previously recorded data (A-B), thus increasing the remaining disk capacity.



- As another example, suppose that you recorded a certain track for ten minutes (A-B), and then re-recorded for five minutes (C-D) on part of that track. In this case, the data that was initially recorded in the A-C region is still usable, so the A-B region that was initially recorded will not be erased even if you turn the power off and back on. In such cases, you can perform the second operation in **[E] DiskBusy** (→p.67) to conserve disk space.

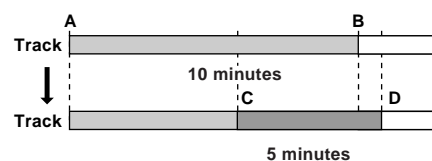

- During recording, disk capacity will be used even if you are not inputting any sound (i.e., silence). You can conserve disk space by using punch-in/out recording only for the necessary areas, or by using the **Erase Track** operation to erase sections which recorded a silence.

■ There is excessive noise or distortion in the input sound or recorded sound!

- ↪ Is [TRIM] set appropriately? If [TRIM] is too high, the sound will be prone to distorting. If it is too low, excessive noise will be heard.
- Set “ChMtr” to **Pre**, and adjust the [TRIM] so that the level meter for each channel goes as high as possible without allowing CLIP to light.
- ↪ Is the distortion occurring at the input or output of the effect?

- For the **input**, set “EfMtr” (→p.47) to **In**, and while watching level meter E, adjust the volume level ([TRIM] and fader) or “Snd” of each channel.
- For the **output**, set “EfMtr” to **Out**, and while watching level meter E, use EDIT EFFECT to try resetting the parameters of the effect (→p.12) or lower the input to the effect (referring to the above paragraph on “Input”).
 - ↵ Is the distortion occurring in the EQ?
- Adjust [TRIM], or “HEQ” or “LEQ.”

■ The sound drops out!

- ↵ If punch-in/out recording or track editing operations at small time intervals are performed repeatedly in the same song, the data will become fragmented, which will adversely affect the performance of the hard disk and may cause the sound to skip.
- If this problem becomes severe, the display will indicate [E] DiskBusy, and the unit will stop. If the sound skips or if the display indicates [E] DiskBusy, refer to the two items for [E] **DiskBusy** (→p.67) and take the appropriate measures.

■ Effect does not function!

Internal effect

- ↵ Is [EFFECT ASSIGN] turned **OFF** (indicator dark)? (→p.64)
- ↵ If [EFFECT ASSIGN] is set to **MASTER (SEND Type)**, has the “Snd” level (→p.58) or “EffRet” level (→p.64) been set to **0** or near **0**?
- ↵ Is [REC SELECT] set to **DIGITAL IN**?
- When **DIGITAL IN** is selected, [EFFECT ASSIGN] will be **OFF**.

External effect when using AUX

- ↵ Is [EFFECT ASSIGN] set to a setting other than **MASTER (SEND Type)** or **OFF** (→p.21)? Also, even if this is turned **OFF**, the AUX will be ignored (displayed as OFF) if [REC SELECT] is set to **DIGITAL IN**.
- ↵ Has the “Aux” level (→p.59) or “AuxRet” level (→p.64) been set to **0** or near **0**?

■ Cursor does not appear!

- ↵ If the recorder is operating (playing etc.), try stopping it.
- ↵ If Scrub is ON, try turning it off.

■ Switches do not function!

- ↵ If the recorder is operating (playing etc.), try stopping it.
- ↵ If Scrub is ON, try turning it off.

■ MIDI sequencer does not synchronize to the D8!

- ↵ Are the MIDI cables connected correctly? (→p.7, p.36)
- ↵ Is a MIDI cable broken?

Cannot use MTC or MIDI Clock to synchronize

- ↵ Is the D8 set as the master and the MIDI sequencer as the slave? (→p.36)
- ↵ Does the synchronization output signal setting of the D8 match the input signal setting of the MIDI sequencer? (→p.36)
- ↵ If “TmpSrc” is set to **Trk**, has MIDI Clock or Tap Tempo data been recorded in the tempo track? (→p.54)
- ↵ Have the settings of the MIDI sequencer been made correctly?
- Refer to the owner’s manual of your MIDI sequencer.

The D8 does not receive MMC

- ↵ Has “RcvMMC” been turned **OFF**? (→p.37)
- ↵ Does the D8’s “Device ID” setting match the Device ID setting of the MIDI sequencer? (→p.37)
- ↵ Has the MIDI sequencer been set to transmit MMC, or does it support MMC?
- Refer to the owner’s manual of your MIDI sequencer.

■ External disk drive is not acknowledged!

Not acknowledged in DriveInfo (→p.49)

- ↵ Is the external disk drive connected correctly? (→p.37)
- ↵ Are two or more disk drives set to the same Device ID?
- For details on setting the Device ID, refer to the owner’s manual for your disk drive.

Cannot select in Drive/Song Select (→p.44)

- ↵ Has the drive been initialized?
- In order to record or copy a song onto an external disk drive (HDD, removable disk), it must be initialized. Initialization is not required in order to perform a backup (on removable disk), and the disk can be used if it is acknowledged in “DiskInfo.”

■ Cannot remove an external removable disk!

- ↵ If the external removable disk drive is selected as the current drive (i.e., selected in EDIT SONG/TRACK P1), removing the disk while operation is in progress may cause data to be lost, so the D8 locks the disk in place. If you simply turn off the power, it will not be possible to remove the disk until the power is turned on again.
- In order to remove the disk, either change the selected drive or song so that a different drive is selected, or refer to “Exchanging disks on a removable disk drive” (→p.39).
- If you have turned the power off by accident, turn the power on again and use the above procedure to remove the disk.
- ↵ On a drive which is not the current drive, you can press the eject button of the drive to remove the disk.

■ When a long time (10 minutes or more) has elapsed after playing back or locating, something is wrong with the playback sound

- ↵ Some drives go into Sleep mode when they have not been accessed for a long time.
- Try pressing the Stop key. Sleep mode will be defeated when the Stop key is pressed.

2. Various messages

Completed

↵The operation was executed successfully. Press the [▶] key to cancel this message.

SongFull

↵The maximum number of songs that can be registered in a disk drive has been reached.

→ Either delete unneeded songs, or select another drive.

Working

↵An operation is in progress. Please wait until this message disappears.

⚠ Do not turn off the power while this message is shown. Doing so may result in loss of data.

■ Error messages

To cancel the message, press the [▶] key.

DAT Read

↵During a Restore operation, a failure occurred while reading data from the DAT.

→ Make sure that the DAT tape contains D8 backup data, and execute the restore operation once again.

Digiln

↵No digital signal is being input to the DIGITAL IN connector.

→ Check the power of the digital device, and its connection to the D8. Some digital devices do not output a digital audio signal unless they are actually playing. In this case, put the digital device in pause mode.

Disk

↵A failure occurred while writing/reading the disk drive.

→ Delete the song which produced this message. If this message continues to appear, re-format the disk drive.

DiskBusy

↵If this message appears when you have just begun using a disk drive, that disk drive is too slow, and cannot be used for recording/playback.

→ Use that disk drive for backing up.

↵If punch recording or track editing has been used so that much of the audio data is fragmented (i.e., located on non-contiguous areas of the disk), reading/writing may become delayed.

→ Find the track(s) which contain fragmented data and re-record this data to de-fragment the data. When you find such a track, copy it to **CLP** (clip), then create a new song, and use the Copy Track operation to copy the data from **CLP** to the song. Set the new song to "**REC SELECT=MASTER**," "**EFFECT ASSIGN=OFF**," "**MASTER FADER=UNITY (=10)**," "**Copy destination track TRACK STATUS=PLAY**," and bounce-record it to a different vacant track. This will produce a track which is identical to the copied track, but whose data is unfragmented. As you did before, copy the data from the new song to **CLP**, and use the Copy Track operation to return it to its original location. This will solve the problem of the slow-down in disk drive operation.

DrvFull

↵There is insufficient drive capacity.

→ Turn the power off, and then on again.

If this message still appears, you can either delete an

unneeded song or select another drive.

IlligFs

↵During a Restore operation, the sampling frequency from the DAT was incorrect.

→ Some DAT machines will output a sampling frequency of 48 kHz or 32 kHz if the tape is not actually being played back, so begin playback.

If this message still appears, make sure that the DAT tape contains D8 backup data. (For details refer to the owner's manual for your DAT.)

In>=Out

↵There is a problem with the In and Out time locations that were set for track editing, auto punch recording, auto play or auto repeat. "In" is later than "Out", or "In" and "Out" are the same.

→ Set "In" and "Out" to the correct settings.

MemFull

↵There is insufficient memory capacity for recording or track editing.

→ Delete unneeded data.

It is also possible to conserve memory by performing item 2 in DiskBusy.

MIDI Ovr

↵Reception of MIDI data failed while receiving MMC or while recording MIDI Clock.

→ Delete unnecessary MIDI data on the transmitting device.

NoData

↵Since the currently selected song contains no data, the operation cannot be executed.

→ Select a different song which contains data.

NumOfTrk

↵During a track edit operation, the numbers of the source and destination tracks are different.

→ Make settings so that there are the same number of source and destination tracks.

↵Since **CLP** contains no data, the operation cannot be executed.

→ Either copy data to **CLP**, or select a different source track.

Protect

↵Writing was not possible because the selected disk drive is write protected.

→ Eject the disk and turn off write protect.

TmpFast

↵Recording failed during tempo recording because the tempo was too fast.

→ If you are recording **MIDIclk**, set the tempo of the MIDI Clock output device (sequencer etc.) to a slightly lower setting.

→ If you are recording **MeasTap**, press the [PLAY] key or foot switch at a slower tempo.

TmpSlow

↵Recording failed during tempo recording because the tempo was too slow.

→ If you are recording **MIDIclk**, set the tempo of the MIDI Clock output device (sequencer etc.) of **40** or higher.

→ If you are recording **MeasTap**, press the [PLAY] key or foot switch at a slightly faster tempo.

Function		Transmitted	Recognized	Remarks
Basic Channel	Default	X	X	
	Changed	X	X	
Mode	Memorized	X	X	
	Messages	X	X	
	Altered	*****	X	
Note Number:	True Voice	X	X	
		*****	X	
Velocity	Note On	X	X	
	Note Off	X	X	
Aftertouch	Polyphonic (Key)	X	X	
	Monophonic (Channel)	X	X	
Pitch Bend		X	X	
Control Change		X	X	
Program Change	Variable Range	X	X	
		X	X	
System Exclusive		X	O #1	#1
System Common	Quarter Frame	O #2	X	#2
	Song Position	O #3	X	#3
	Song Select	X	X	
	Tune	X	X	
System Real Time	Clock	O #4	O #5	#4
	Command	O	O	#5
Aux Messages	Local On/Off	X	X	
	All Notes Off	X	X	
	Active Sense	X	X	
	Reset	X	X	
Notes *1: Received when RcvMMC=O. *2: Transmitted when Gen=MTC30. *3: Transmitted when Gen=Clock. *4: Transmitted when Gen=Clock. *5: Received when MIDClk is selected for TempoRec and tempo is being recorded.				

Mode 1:OMNI ON, POLY

Mode 2:OMNI ON, MONO

O :Yes

Mode 3:OMNI OFF, POLY

Mode 4:OMNI OFF, MONO

X :No

68 Consult your local Korg distributor for more information on MIDI IMPLEMENTATION.

4. Block Diagram

■ Effect Assign = Master (Send Type)

EffectAssign=Master(SendType)

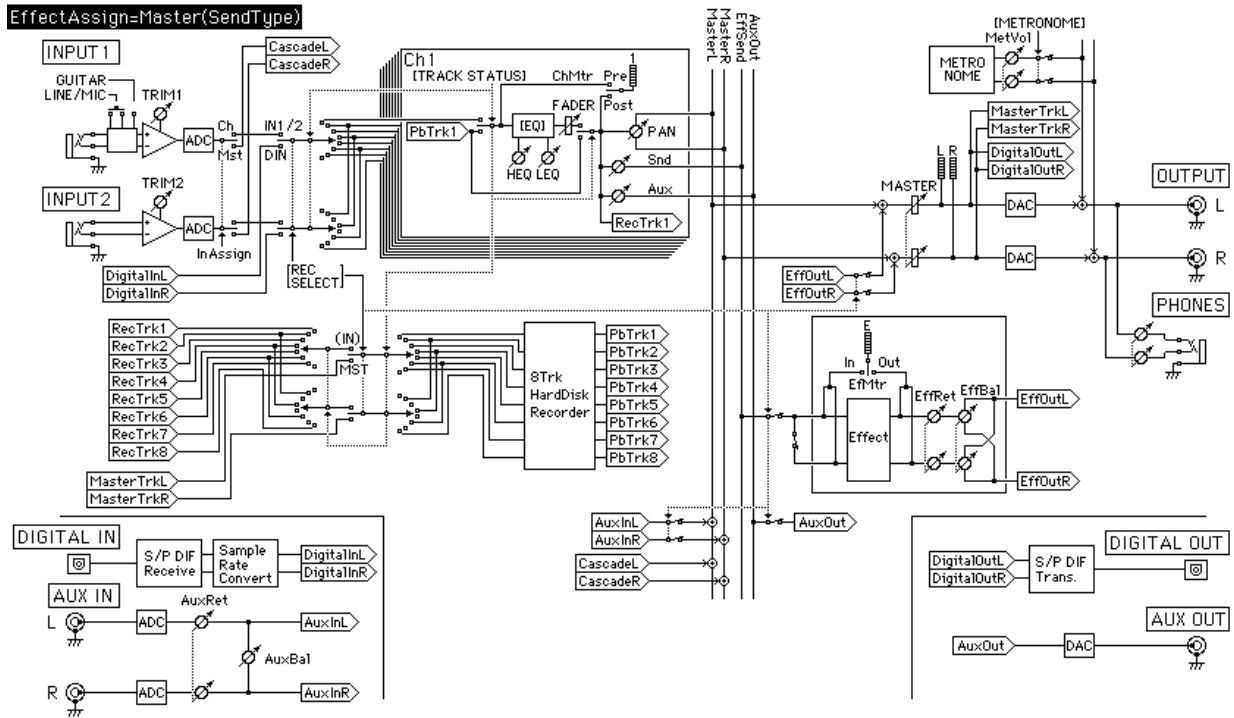

■ Effect Assign = Master (Global Type)

EffectAssign=Master(GlobalType)

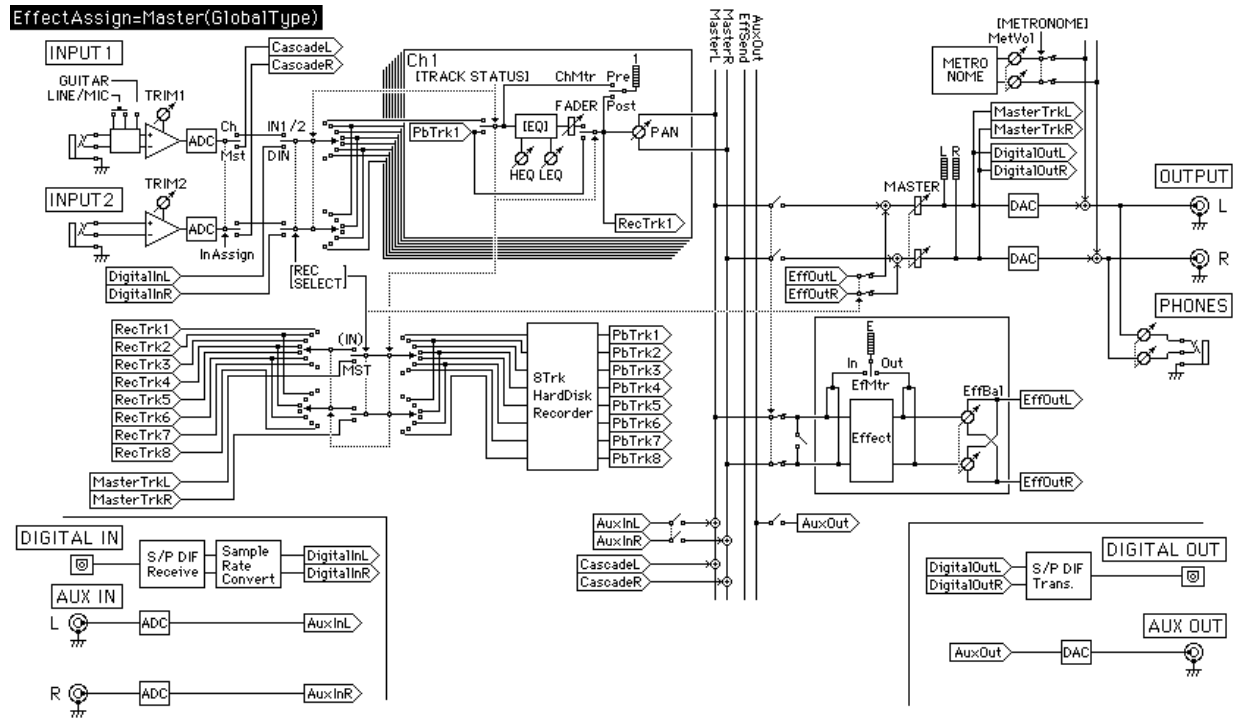

■ Effect Assign = Input 1/2

EffectAssign=Input1/2

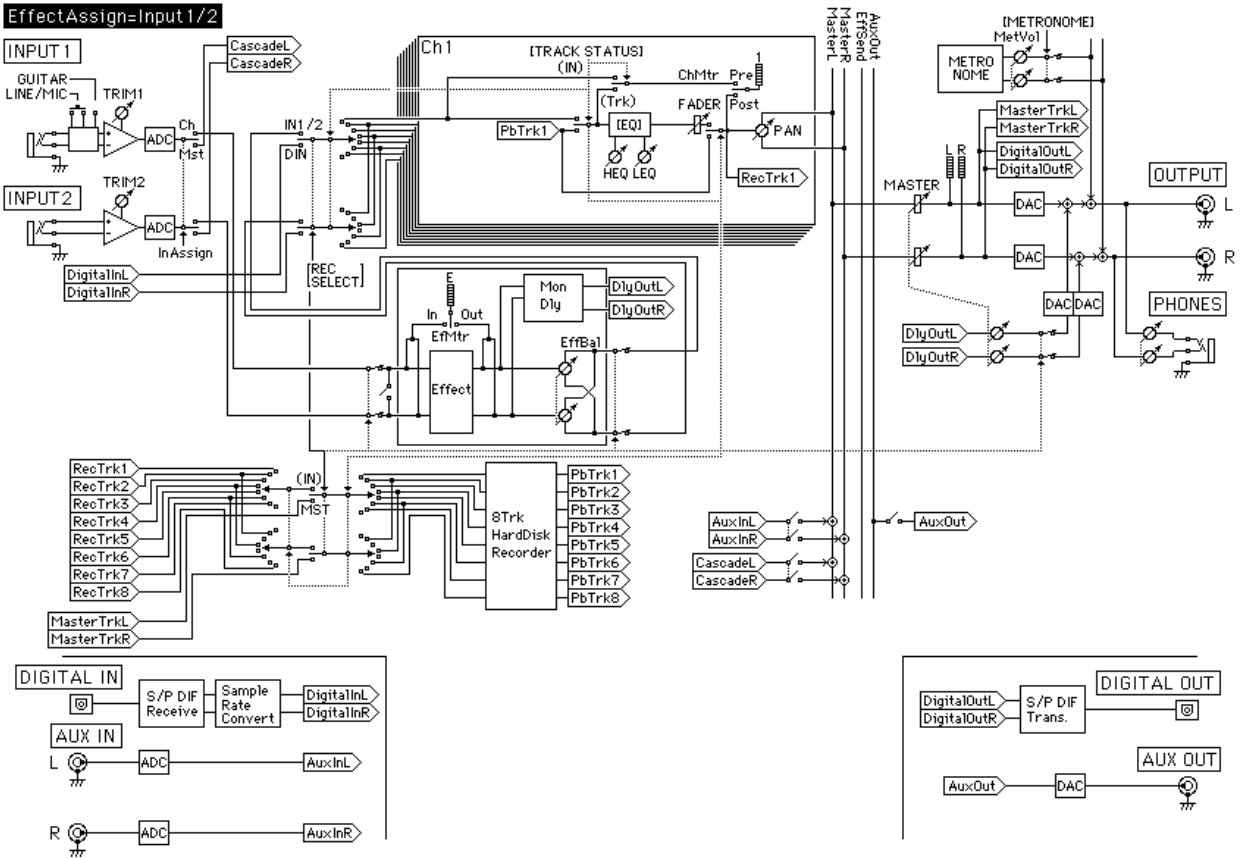

5. Effect Program List

CATEGORY No. PROGRAM NAME	DISPLAY No. NAME	I/O TYPE	PROGRAM CHAIN			
			EFFECT1	EFFECT2	EFFECT3	EFFECT4
Reverb/Delay						
1 ROOM REVERB	RD1: ∞ ROOM	C	S.4BEQ	ROOM		
2 HALL REVERB	RD2: ∞ HALL	C	S.4BEQ	HALL		
3 PLATE REVERB	RD3: ∞ PLATE	C	S.4BEQ	PLATE		
4 EARLY REFLECTION	RD4: ∞ ER	C	S.4BEQ	ER		
5 DELAY	RD5: DELAY	A	DLY			
6 STEREO DELAY	RD6: ∞ DLY	B	S.DLY			
7 CROSS DELAY	RD7: ∞ X.DLY	C	X.DLY			
8 DUAL DELAY	RD8: ∞ D.DLY	B	DualDLY			
9 TEMPO DELAY	RD9: ∞ T.DLY	B	TmpoDLY			
Modulation						
1 TREMOLO	MO1: ∞ TREM	B, C	S.TREM			
2 PHASER	MO2: ∞ PHASE	B, C	S.PHASE			
3 DUAL PITCH SHIFTER	MO3: D.PTCH	A	D.PITCH			
4 CHORUS/FLANGER	MO4: ∞ CH/FL	B, C	S.CH/FL			
5 ENSEMBLE	MO5: ENSEMB	A	ENSEMBL			
Dynamics						
1 TOTAL LIMITER	DY1: ∞ LIMIT	B, C	S.COMP	S.4BEQ		
2 REMASTER POP	DY2: ∞ POP	B, C	S.COMP	S.4BEQ		
3 REMASTER DANCE	DY3: ∞ DANCE	B, C	S.COMP	S.4BEQ		
4 REMASTER L.A.STUDIO	DY4: ∞ L.A.	B, C	S.COMP	S.4BEQ		
Equalizer						
1 HI-BOOST	EQ1: ∞ HiBST	B	S.4BEQ			
2 HI-CUT	EQ2: ∞ HiCUT	B	S.4BEQ			
3 MID-BOOST	EQ3: ∞ MdBST	B	S.4BEQ			
4 MID-CUT	EQ4: ∞ MdCUT	B	S.4BEQ			
5 LOW-BOOST	EQ5: ∞ LoBST	B	S.4BEQ			
6 LOW-CUT	EQ6: ∞ LoCUT	B	S.4BEQ			
Electric Guitar						
1 ROCK LEAD	EG1: ROCK	A	DISTORT	NR	AMP SIM	DLY
2 GRUNGE LEAD	EG2: GRUNGE	A	DISTORT	NR	AMP SIM	DLY
3 BLUES	EG3: BLUES	A	DISTORT	NR	AMP SIM	DLY
4 CLEAN	EG4: CLEAN	A	COMP	4BEQ	CH/FL	S.DLY
5 SIMULATOR-STACK	EG5: STACK	A	AMP SIM	CAB RES	CH/FL	S.DLY
6 SIMULATOR-SOLID STATE	EG6: SS	A	AMP SIM	CAB RES	CH/FL	S.DLY
7 SIMULATOR-TREM	EG7: TREM	A	AMP SIM	CAB RES	TREMOLO	DLY
8 SIMULATOR-PHASE	EG8: PHASE	A	AMP SIM	CAB RES	PHASER	DLY
9 E.BASS SIM	EG9: EB SIM	A	COMP	4BEQ	PITCH	DLY
Acoustic Guitar						
1 12 STRING SIM	AG1: 12STR	A	COMP	4BEQ	PITCH	DLY
2 CHORUS	AG2: CHORUS	A	COMP	4BEQ	CH/FL	S.DLY
3 NYLON STRING SIM	AG3: NYLON	A	COMP	4BEQ	CH/FL	S.DLY
Electric Bass						
1 FINGER	EB1: FINGER	A	COMP	4BEQ	CH/FL	S.DLY
2 SLAP	EB2: SLAP	A	COMP	EXCITER	CH/FL	S.DLY
3 PICKED	EB3: PICKED	A	DISTORT	NR	FILTER	DLY
4 FILTER	EB4: FILTER	A	DISTORT	NR	FILTER	DLY
5 WOODBASS SIM	EB5: WB SIM	A	COMP	4BEQ	GATE	
Vocal						
1 ROCK VOCAL	VO1: PUNCH	A	COMP	EXCITER	CH/FL	S.DLY
2 VOCAL DOUBLE	VO2: DOUBLE	A	COMP	4BEQ	CH/FL	S.DLY
3 CHORUS	VO3: VoxCHO	A	COMP	EXCITER	PITCH	DLY
4 DEATHMETAL VOICE	VO4: VoxDST	A	DISTORT	NR	AMP SIM	DLY
5 DE-ESSER	VO5: DE-ESS	A	DEESSER			
Drums						
1 ROCK DRUM	DR1: ∞ ROCK	B, C	S.COMP	S.4BEQ		
2 JAZZ DRUM	DR2: ∞ JAZZ	B, C	S.COMP	S.4BEQ		
3 POWER DRUM	DR3: ∞ POWER	B, C	S.COMP	S.XCITE		
4 INDUSTRIAL	DR4: ∞ INDST	B	DECIMA	S.4BEQ		
5 DIST DRUM	DR5: ∞ DIST	B	S.DIST	S.NR	S.4BEQ	
Keyboard						
1 ST. POP PIANO	KB1: ∞ PopPf	B, C	S.COMP	S.4BEQ		
2 PAN E.PIANO	KB2: PAN.Pf	A	COMP	4BEQ	PAN	S.DLY
3 ROTARY ORGAN	KB3: ORGAN	A	DISTORT	NR	AMP SIM	PHASER
4 STRINGS	KB4: STRING	A	COMP	4BEQ	CH/FL	S.DLY
5 BRASS ENSEMBLE	KB5: BRASS	A	COMP	EXCITER	CH/FL	S.DLY
Special Effects						
1 RING MODULATOR	SE1: RING	A	RingMOD			
2 AUTOWAH	SE2: A.WAH	A	WAH+OD	NR	AMP SIM	DLY
3 ROTARY SPEAKER	SE3: ROTARY	A	ROTARY			
4 DOPPLER	SE4: DOPLER	A	DOPPLER			
5 LO-FI	SE5: ∞ LO-FI	B	DECIMA	S.4BEQ		
6 TELEPHONE VOICE	SE6: ∞ PHONE	B	DECIMA	S.4BEQ		
7 AM RADIO	SE7: ∞ RADIO	B	DECIMA	S.4BEQ		
8 TURNTABLE SIMULATOR	SE8: ∞ PHONO	B	PHONO			
9 CENTER CANCELLER	SE9: ∞ CnCNL	C	CnCNL			
User area (With the factory settings, this contains the same programs as presets RD1..SE9.) U01: ∞ ROOM ~ U65: ∞ CnCNL						

(Default= ∞ RD1:ROOM)

* The I/O TYPE item indicates the input/output type of the program.

In the case of programs with two or more types listed, the I/O type will be determined by the settings of the internal parameters for the effects which make up the chain.

A ... [Mono-in/stereo-out] type B ... [Mono-in/mono-out] x 2 channel type C ... [Stereo-in/stereo-out] type

* Preset programs for which two channels can be input simultaneously are indicated by a " ∞ " symbol at the beginning of the displayed program name.

6. Effect Parameter List

Effect type name as displayed _ (Unabbreviated effect type name) _ Remark
Parameter name as displayed _ (Unabbreviated parameter name) _ Setting range _ Remark

4BEQ (4 Band Equalizer)

This is a equalizer that allows you to adjust the tone in four frequency bands. Positive (+) settings will boost the gain, and negative (-) settings will cut it.

LoG (Low Gain)	-15...+15dB	Low gain
LoF (Low Fc)	80...1.00k(Hz)	Low cutoff frequency
LMG (LowMid Gain)	-15...+15dB	Low Mid gain
LMF (LowMid Fc)	80...16.0k(Hz)	Low Mid center frequency
LMQ (LowMid Q)	WIDE,0.6...9.9,NRRW	Low Mid bandwidth
HMG (HiMid Gain)	-15...+15dB	High Mid gain
HMF (HiMid Fc)	80...16.0k(Hz)	High Mid center frequency
HMQ (HiMid Q)	WIDE,0.6...9.9,NRRW	High Mid bandwidth
HIG (Hi Gain)	-15...+15dB	High gain
HIF (Hi Fc)	1.00k..16.0k(Hz)	High cutoff frequency
TRM (Trim)	-24...+6dB	Input level

S.4BEQ (Stereo 4Band Equalizer)

This is a version of 4BEQ which allows 2-channel simultaneous input/output. The parameters are the same as for 4BEQ.

AMP SIM (Amp Simulator)

This effect simulates the acoustical characteristics of a guitar amp. Even if you are recording with a direct line, this effect will realistically simulate the sound of an actual guitar amp.

Type (AmpType)	AMP1...5	Select the type of guitar amp
----------------	----------	-------------------------------

CAB RES (Cabinet Resonator)

This effect simulates the acoustical characteristics and resonances of a guitar amp speaker cabinet. As with Amp Simulator, this is ideal for use with direct line recording.

SIZE (Size)	0...50	Cabinet size
DEPTH (Depth)	0...50	Depth of the effect

CH/FL (Chorus/Flanger)

This effect gives a sense of pitch movement and depth to the sound. Adjusting the Delay Time will significantly change the effect.

SPD (Speed)	0.01...16.0(Hz)	Modulation speed
DEPTH (Depth)	0...50	Modulation depth
DLY (Delay)	0.1...60ms	Delay time
Fback (Feedback)	-50...+50	Feedback amount
H.Damp (HighDamp)	0...50	High frequency attenuation of the feedback
L.Damp (LowDamp)	0...50	Low frequency attenuation of the feedback
MIX (Wet/Dry)	DRY,1,2,...,49,WET	Balance between the effect sound and direct sound

S.CH/FL (Stereo Chorus/Flanger)

This is a version of CH/FL which allows simultaneous 2-channel input. In addition to the parameters listed for CH/FL, the following parameter can also be set.

PHASE (Phase)	0...180	Relative phase difference between channels
---------------	---------	--

CnCNL (Center Canceller)

When existing music (a stereo source) is input to this effect, sounds which are panned to the center such as vocals or lead guitar will be canceled. In addition, you can control the pitch.

PITCH (Pitch)	-12,...,-1,off,+1,...+12	Pitch shift amount in semitones
ADJ (Adjustment)	L50...0...R50	Cancel position

COMP (Compressor/Limiter)

Limiter: An effect which evens out the volume of the input signal.
Compressor: An effect which compresses the input signal to make it more consistent and give it more punch.

When the Ratio value is inf:1, this effect functions as a Limiter.

When the Ratio value is other than inf:1, this effect functions as a Compressor.

THR (Threshold)	-1 ... -40dB	Level at which the effect will begin to apply
RTO (Ratio)	1.0:1...inf:1	Compression ratio
ATK (Attack)	FAST,1,...,49,SLOW	Attack length
REL (Release)	FAST,1,...,49,SLOW	Release length
LVL (Level)	0...50	Effect level

S.COMP (Stereo Compressor/Limiter)

This is a version of COMP which allows simultaneous 2-channel input. The Link parameter allows you to specify the trigger by which the effect will be applied.

THR (Threshold)	-1 ... -40dB	Level at which the effect will begin to apply
RTO (Ratio)	1.0:1...inf:1	Compression ratio
ATK (Attack)	FAST,1,...,49,SLOW	Attack length
REL (Release)	FAST,1,...,49,SLOW	Release length
LVL (Level)	0...50	Effect level
LINK (Link)	OFF,L,R,L+R	Trigger channel

DECIMA (Stereo Decimator)

This is a stereo effect which lowers the sampling frequency to create the rough sound typical of a cheap sampler.

PreLPF (Pre LPF)	0...50	Low pass filter which reduces the intermodular noise produced by lowering the sampling frequency
Fs (Sampling Fc)	1k...36kHz	Sampling frequency
H.Damp (High Damp)	0...50	High frequency attenuation

MIX (Wet/Dry)	DRY,1,2,...,49,WET	Balance between the effect sound and the direct sound
---------------	--------------------	---

DEESSER (De-Esser)

This effect attenuates undesired sibilant sounds ("s" sounds).

SENS (Sens)	0...50	Sensitivity
Fc (Eq Freq.)	80...16.0k(Hz)	Center frequency of the side band EQ
G (Eq Gain)	-15...+15dB	Gain of the side band EQ
Q (Eq Q)	0.5...10	Bandwidth of the side band EQ

DISTORT (Distortion)

This effect distorts the input signal.

TYPE (Type)	OD,DIST,HI-G	Drive type
DRIVE (Drive)	0...50	Distortion
TRE (Treble)	-15...+15dB	High frequency tone
LVL (Level)	0...50	Output level
MIX (Wet/Dry)	DRY,1,2,...,49,WET	Balance between the effect sound and the direct sound

S.DIST (Stereo Distortion)

This effect distorts the input signal. It allows 2 channels of simultaneous input.

DRIVE (Drive)	0...50	Distortion
TRE (Treble)	-15...+15dB	High frequency tone
LVL (Level)	0...50	Output level
MIX (Wet/Dry)	DRY,1,2,...,49,WET	Balance between the effect sound and the direct sound

DLY (Mono Delay)

This effect applies a time delay to the input sound.

T (Time)	1ms...1s	Delay time
Fback (Feedback)	0...50	Feedback amount
H.Damp (HighDamp)	0...50	High frequency attenuation of the feedback
L.Damp (LowDamp)	0...50	Low frequency attenuation of the feedback
MIX (Wet/Dry)	DRY,1,2,...,49,WET	Balance between the effect sound and the direct sound

DualDLY (Dual Delay)

This is a delay in which the L/R channel parameters can be set independently.

LT (L Time)	1ms...1s	L channel delay time
RT (R Time)	1ms...1s	R channel delay time
LFBck (L Feedback)	0...50	L channel feedback amount
RFBck (R Feedback)	0...50	R channel feedback amount
LHDamp (L HiDamp)	0...50	High frequency attenuation of the L channel feedback
RHDamp (R HiDamp)	0...50	High frequency attenuation of the R channel feedback
LLDamp (L Low-Damp)	0...50	Low frequency attenuation of the L channel feedback
RLDamp (R Low-Damp)	0...50	Low frequency attenuation of the R channel feedback
LMx (L Wet/Dry)	DRY,1,2,...,49,WET	Balance between the L channel effect sound and direct sound
RMx (R Wet/Dry)	DRY,1,2,...,49,WET	Balance between the R channel effect sound and direct sound

S.DLY (Stereo Delay)

This is a version of Mono Delay which allows 2-channel simultaneous input and output.

The parameters are the same as for Mono Delay.

TmpoDLY (Tempo Delay)

This effect lets you specify the delay time in terms of a specified note value and tempo.

TEMPO (Tempo)	30...250	Tempo
NOTE (NoteLength)	4...64T	Note value length
Fback (Feedback)	0...50	Feedback amount
H.Damp (HighDamp)	0...50	High frequency attenuation of the feedback
L.Damp (LowDamp)	0...50	Low frequency attenuation of the feedback
MIX (Wet/Dry)	DRY,1,2,...,49,WET	Balance between the effect sound and the direct sound

X.DLY (Cross Delay)

This is a delay in which the feedback is alternated between the L/R channels. Delay time can be set independently for each channel.

LT (L Time)	1ms...1s	L channel delay time
RT (R Time)	1ms...1s	R channel delay time
Fback (Feedback)	0...50	Feedback amount
H.Damp (HighDamp)	0...50	High frequency attenuation of the feedback
L.Damp (LowDamp)	0...50	Low frequency attenuation of the feedback
MIX (Wet/Dry)	DRY,1,2,...,49,WET	Balance between the effect sound and the direct sound

DOPPLER (Doppler)

This simulates the Doppler effect.

SPD (Speed)	0.01...4.00(Hz)	Speed of movement
PITCH (Pitch)	0...50	Pitch difference of the Doppler effect
SPRED (Spread)	-50...+50	Left/right spread
DLY (Delay)	1ms...1s	Delay time
MIX (Wet/Dry)	DRY,1,2,...,49,WET	Balance between the effect sound and the direct sound

ENSEMBL (Ensemble)

This is an ensemble effect with multiple chorus blocks. It produces a sense of three-dimensional depth.

SPD (Speed)	0.01...16.0(Hz)	Modulation speed
DEPTH (Depth)	0...50	Modulation depth
H.Damp (HighDamp)	0...50	High frequency attenuation
L.Damp (LowDamp)	0...50	Low frequency attenuation
MIX (Wet/Dry)	DRY,1,2,...,49,WET	Balance between the effect sound and the direct sound

ER (Early Reflections)

Out of the various reflected components that make up reverberation, this effect isolates only the early reflections. It gives the sound a sense of presence and reality.

CRV (Curv)	SHARP, LOOSE, MOD, REV	Select the attenuation curve of the early reflections
T (ER Time)	10...400ms	Length of the early reflections
PDL (PreDelay)	0...200 ms	Time from the original sound until the first early reflection
H.Damp (HighDamp)	0...50	High frequency attenuation
MIX (Wet/Dry)	DRY,1,2,...,49,WET	Balance between the effect sound and the direct sound

EXCITER (Exciter)

This effect adds sparkle to the sound, giving it greater definition.

BLEND (Blend)	0...50	Depth of the exciter effect
EMPHA (Emphatic Point)	0...100	The frequency that is emphasized

S.XCITE (Stereo Exciter)

This is a variation of EXCITER which allows simultaneous 2-channel input/output. The parameters are the same as for Exciter.

FILTER (Filter)

This is a filter with resonance, whose frequency can be controlled by an envelope.

TYPE (Type)	LPF,BPF,HPF	Filter type
SENS (Sens)	0...50	Sensitivity
ATK (Attack)	FAST,1,2,...,49,SLOW	Strength of the attack
MANUAL (Manual)	0...50	Frequency at which the effect will apply
RES (Resonance)	0...50	Amount (strength) of resonance
PLTY (Polarity)	UP, DOWN	Polarity

GATE (Gate)

This effect mutes any signals which are lower than the specified level.

THR (Threshold)	-80...-1dB	Level at which the effect will begin to apply
ATK (Attack)	FAST, 1...49, SLOW	Attack length
REL (Release)	FAST, 1...49, SLOW	Release length

NR (Noise Reduction)

This effect reduces noise.

THR (Threshold)	-1 ... -40dB	Level at which the effect begins to apply
-----------------	--------------	---

S.NR (Stereo NR)

This is a version of NR which allows 2-channel simultaneous input. The parameters are the same as for NR.

PAN (Pan)

This effect moves the sound between left and right. You can specify the location of the center position.

SPD (Speed)	0.01...16.0(Hz)	Modulation speed
DEPTH (Depth)	0...50	Modulation depth
BAL (LR Balance)	L50,L49..0,R1,..R50	Location of center position

PHASER (Phaser)

This effect moves the phase of the sound to create modulation.

SPD (Speed)	0.01...16.0(Hz)	Speed
DEPTH (Depth)	0...50	Modulation depth
MANUAL (Manual)	0...50	Frequency at which the effect is applied
RES (Resonance)	-50...+50	Amount of resonance
MIX (Wet/Dry)	DRY,1,2,...,49, WET	Balance between the effect sound and the direct sound

S.PHASE (Stereo Phaser)

This is a version of PHASER which allows 2-channel simultaneous input. In addition to the parameters of PHASER, the following can also be adjusted.

PHASE (Phase)	0...180	Relative phase difference between channels
---------------	---------	--

PHONO (Turntable SIM)

This simulates a record player. Scratch noise can also be added.

RPM (Rpm)	33,45,78	Rotational speed
WOW (Wow&Flutter)	0...50	Pitch instability caused by variation in rotational speed
HiCUT (High Cut)	0...50	High frequency cut filter
NOISE (Scratch noise)	0...50	Scratch noise

PITCH (Pitch Shifter)

This effect changes the pitch of the input signal.

PITCH (Pitch)	-24...+24	Pitch shift amount in semitone units
FINE (Fine)	-50...+50	Pitch shift amount in 1-cent steps
DLY (Delay)	1ms...1s	Delay time from the input signal
Fback (Feedback)	0...50	Amount of feedback
H.Damp (HighDamp)	0...50	High frequency attenuation of the feedback
TYPE (Type)	SLOW,FAST	Response speed. With a setting of SLOW, the response will be slower, but the tone will change less.
MIX (Wet/Dry)	DRY,1,2,...,49,WET	Balance between the effect sound and the direct sound

D.PITCH (Dual Pitch Shifter)

This effect provides two pitch shifter units.

PTCH1 (Pitch1)	-24...+24	Pitch shift 1 amount in semitone units
FINE1 (Fine1)	-50...+50	Pitch shift 1 amount in one-cent steps
HDamp1 (High Damp1)	0...50	High frequency attenuation of feedback 1
LVL1 (Level1)	0...50	Delay time 1 from the input signal
PITCH2 (Pitch2)	-24...+24	Pitch shift 2 amount in semitone units
FINE2 (Fine2)	-50...+50	Pitch shift 2 amount in one-cent steps
HDamp2 (High Damp2)	0...50	High frequency attenuation of feedback 2
LVL2 (Level2)	0...50	Delay time 2 from the input signal
TYPE (Type)	SLOW, FAST	Response speed. With a setting of SLOW, the response will be slower, but the tone will change less.
MIX (Wet/Dry)	DRY,1,2,...,49,WET	Balance between the effect sound and the direct sound

HALL (Hall Reverb)

This effect simulates the reverberation and ambiance of a concert hall.

T (Time)	0.26...16s	Reverb time
PDL (PreDly)	0...300ms	Delay time from the original sound
H.Damp (HighDamp)	0...25	High frequency attenuation
MIX (Wet/Dry)	DRY,1,2,...,49,WET	Balance between the effect sound and the direct sound

ROOM (Room Reverb)

This simulates the reverberation of a room. For the parameters, refer to Hall Reverb.

T (Time)	0.10...5.2s	Reverb time
----------	-------------	-------------

PLATE (Plate Reverb)

This simulates a plate reverb unit. For the parameters, refer to Hall Reverb.

T (Time)	0.26...16s	Reverb time
----------	------------	-------------

RingMOD (Ring Modulator)

This effect multiplies the effect by a sine wave to create metallic sounds.

Fc (Mod Fc)	50Hz...5000Hz	Frequency of the oscillator
MIX (Wet/Dry)	DRY,1,2,...,49,WET	Balance between the effect sound and the direct sound

ROTARY (Rotary Speaker SIM)

This effect simulates a rotary speaker.

Hspd (Horn Speed)	0.01...16.0(Hz)	Rotational speed of the horn
Rspd (RotorSpeed)	0.01...16.0(Hz)	Rotational speed of the rotor
BAL (Balance)	0...50	Volume balance between the low frequency rotor and the high frequency horn

TREMOLO (Tremolo)

This effect modulates the volume of the input signal.

SPD (Speed)	0.01...16.0(Hz)	Modulation speed
DEPTH (Depth)	0...50	Modulation depth

S.TREM (Stereo Tremolo)

This is a version of Tremolo which allows 2-channel simultaneous input. In addition to the parameters of Tremolo, you can adjust the following.

PHASE (Phase)	0...180	Relative phase difference between channels
---------------	---------	--

WAH+OD (Wah+Overdrive)

This is an auto-wah effect with overdrive.

PLTY (Polarity)	UP,DOWN	Polarity
SENS (Sens)	0...50	Sensitivity
ATK (Attack)	FAST,1,...,49,SLOW	Attack strength
MANUAL (Manual)	0...50	Frequency at which the effect is applied
DRIVE (Drive)	0...50	Distortion
LVL (Level)	0...50	Output level

MoniDly (Monitor Delay)

This is a delay especially designed for monitoring.

T (Time)	1...200ms	Delay time
Fback (Feedback)	0...50	Feedback amount
H.Damp (HighDamp)	0...50	High frequency attenuation of feedback
LVL (Level)	0...50	Output level

7. Metronome Type List

Time	No. Name	bar	Set	Time	No. Name	bar	Set	Time	No. Name	bar	Set
1/ 4	01 Metro1	1	--	4/ 4	33 Jungle1	4	Jungle	5/ 8	01 Metro5	1	--
	02 Hihat1	1	--		34 Jungle2	4	Jungle		02 Hihat5	1	--
2/ 4	01 Metro2	1	--	35 16Beat1	1	Tight	6/ 8	01 Metro6	1	--	
	02 Hihat2	1	--	36 16Beat2	1	Tight		02 Hihat6	1	--	
	03 2Beat1	1	Tight	37 16Beat3	1	Loose		03 6/8-1	2	Tight	
	04 2Beat2	2	Loose	38 16Beat4	1	Loose		04 6/8-2	4	Tight	
	05 March	4	March	39 16Beat5	2	Tight		05 6/8-3	2	Tight	
3/ 4	01 Metro3	1	--	40 16Beat6	2	Tight		06 6/8Shfl	4	Loose	
	02 Hihat3	1	--	41 16Beat7	2	Tight		07 Fusion	2	Tight	
	03 3Beat1	2	Tight	42 16Beat8	4	Tight		08 Ballad2	4	Rim	
	04 3Beat2	4	Loose	43 16Beat9	4	Tight		09 World	4	Latin1	
	05 3/4Jazz	4	Loose	44 HipHop1	4	Tight	7/ 8	01 Metro7	1	--	
4/ 4	01 Metro4	1	--	45 HipHop2	4	Tight		02 Hihat7	1	--	
	02 Hihat4	1	--	46 Samba	4	Tight	8/ 8	01 Metro8	1	--	
	03 8Beat1	1	Tight	47 Bossa	2	Rim		02 Hihat8	1	--	
	04 8Beat2	1	Tight	48 LtDance	2	Latin1	10/ 8	01 Metro10	1	--	
	05 8Beat3	1	Tight	49 Rosanna	2	Tight		02 Hihat10	1	--	
	06 8Beat4	1	Tight	50 Rydeen	1	Tight	12/ 8	01 Metro12	1	--	
	07 8Beat5	1	Tight	51 Jazz1	4	Loose		02 Hihat12	1	--	
	08 8Beat6	1	Tight	52 Jazz2	4	Loose	16/ 8	01 Metro16	1	--	
	09 8Beat7	1	Tight	5/ 4	01 Metro5	1		--	02 Hihat16	1	--
	10 8Beat8	2	Tight		02 Hihat5	1	--	1/16	01 Metro1	1	--
	11 8Beat9	2	Tight		03 5Beat1	1	Tight		02 Hihat1	1	--
	12 8Shfl1	4	Tight		04 5Beat2	1	Tight	2/16	01 Metro2	1	--
	13 8Shfl2	1	Loose		05 5/4Jazz	2	Loose		02 Hihat2	1	--
	14 Rock1	2	Tight	6/ 4	01 Metro6	1	--	3/16	01 Metro3	1	--
	15 Rock2	2	Tight		02 Hihat6	1	--		02 Hihat3	1	--
	16 Rock3	1	Tight		7/ 4	01 Metro7	1	--	4/16	01 Metro4	1
	17 RokShfl	2	Tight	02 Hihat7		1	--	02 Hihat4		1	--
18 RockRim	4	Rim	03 7Beat1	1		Tight	5/16	01 Metro5	1	--	
19 Funk	4	Tight	04 7Beat2	1		Tight		02 Hihat5	1	--	
20 R&B	2	Tight	05 7/4Jazz	1		Loose	6/16	01 Metro6	1	--	
21 Motown1	2	Loose	8/ 4	01 Metro8	1	--		02 Hihat6	1	--	
22 Motown2	2	Loose		02 Hihat8	1	--	7/16	01 Metro7	1	--	
23 Ballad1	4	Rim	10/ 4	01 Metro10	1	--		02 Hihat7	1	--	
24 Surf	2	Tight		02 Hihat10	1	--	8/16	01 Metro8	1	--	
25 Reggae	2	Rim	1/ 8	01 Metro1	1	--		02 Hihat8	1	--	
26 Disco	4	Tight		02 Hihat1	1	--	10/16	01 Metro10	1	--	
27 Latin1	1	Latin1	2/ 8	01 Metro2	1	--		02 Hihat10	1	--	
28 Latin2	1	Latin2		02 Hihat2	1	--	12/16	01 Metro12	1	--	
29 Club1	1	Analog	3/ 8	01 Metro3	1	--		02 Hihat12	1	--	
30 Club2	2	Analog		02 Hihat3	1	--	16/16	01 Metro16	1	--	
31 Dance1	2	Analog	4/ 8	01 Metro4	1	--		02 Hihat16	1	--	
32 Dance2	4	Analog		02 vHihat4	1	--					

(Default=4/4, 01:Metro4)

* bar indicates the number of measures in the pattern.

For example if you listen for eight measures, 8Beat1 will repeat 8 times since it is a 1-measure pattern, and 8Shfl2 will repeat twice since it is a 4-measure pattern.

* Set is the type of drum set that is used.

8. Demo Song List

01 : Scukyll Express

Paul Kramer – Guitar, and Drums

Dave Zeltner – KeyBoards, Bass, and Drums

song copyright © 1996 Remark Music

02 : Moonlit sea

written by Yuko Asai

Yuko Asai – All instruments and voices

song copyright © 1997 Yuko Asai

©1997 KORG Inc. all rights reserved

9. D8 Specifications

■ Specifications

< Recorder section >

Tracks	: 8 tracks (50 songs × 8 tracks) : 8 tracks simultaneous playback, 2 tracks simultaneous recording, 6 tracks playback + 2 tracks recording
Recording format	: 16 bit uncompressed, 44.1 kHz
Recording time	: 34 minutes of 8 tracks recording maximum (when using internal 1.4 Gbyte hard disk)
Maximum recording capacity	: Internal + 4 Gbyte × 7 drives
Songs	: 50 songs (Auto Save function makes save/load operation unne- cessary when switching songs)
Locate points	: 3 points per song
Mark points	: 100 points per song
Metronome/Rhythm patterns	: 131 patterns
MIDI synchronization	: Transmitted (MTC, MIDI Clock) : Received (MMC) : Tempo Map (10 events per song) : Sync Track (1 track per song)
Editing	: Track (Copy, Insert, Erase, Delete, Swap) (Tracks can be copied between songs.) : Song (Copy, Move, Delete, Recover) : Undo, Redo
Counter/Locator format	: Min/Sec/mSec, Meas/Beat/Tick, Min/Sec/Frame (30 NDF only)

< Mixer section >

Structure	: 12 channel 4 bus mixer (left and right master sends, internal effect send, external AUX send), 1 master stereo out
Signal processing	: 24 bit, 44.1 kHz
Equalizer	: High (10 kHz ±15 dB) : Low (100 Hz ±15 dB)
Scene memory	: 20 scenes per song

< Multi-effect section >

Structure	: 1in-2out or 2in-2out or 1in-1out × 2
Signal processing	: 24 bit 44.1 kHz
Programs	: 65 preset, 65 user
Chains	: 38 types
Effects	: 50 types

< General >

Display	: 4" x .9" custom LCD
Power supply	: AC 9 V AC/AC power supply
Power consumption	: 16 W (AC 9 V 2.0 A max.)
Dimensions	: 15.2" (W) × 9.8" (D) × 3.3" (H)
Weight	: 5.7 lbs.

■ Main formats

Frequency response	: 10 Hz – 21 kHz ±1 dB @+4 dBu, 10 k-ohm load
S/N	: 92 dB or better @IHF-A
Total harmonic distortion	: less than 0.03% 20 Hz – 20 kHz @+16 dBu, 10 k-ohm load
A/D conversion	: 18 bit linear, uncompressed
D/A conversion	: 18 bit linear, uncompressed
Sampling frequency	: 44.1 kHz

■ Analog/digital input/output formats

< LINE, MIC/GUITAR INPUT1 >

Connector	: 1/4" TRS phone jack (balanced) @LINE, MIC (unbalanced) @GUITAR
Input impedance	: 10 k-ohm @ LINE, MIC 1 M-ohm @GUITAR
Nominal level	: -50 dBu @TRIM=max. +4 dBu @TRIM=min.
Maximum level	: -38 dBu @TRIM=max. +16 dBu @TRIM=min.
Source impedance	: 600 ohms

< LINE, MIC INPUT2 >

Connector	: 1/4" TRS phone jack (balanced)
Input impedance	: 10 k-ohms
Nominal level	: -50 dBu @TRIM=max. +4 dBu @TRIM=min.
Maximum level	: -38 dBu @TRIM=max. +16 dBu @TRIM=min.
Source impedance	: 600 ohms

< AUX INPUTS L/R >

Connector	: RCA phono jack
Input impedance	: 10 k-ohms
Nominal level	: -10 dBu
Maximum level	: +2 dBu
Source impedance	: 600 ohms

< MASTER OUTPUTS L/R >

Connector	: RCA phono jack
Output impedance	: 150 ohms
Nominal level	: -10 dBu
Maximum level	: +2 dBu
Load impedance	: 10 k-ohms or greater

< AUX OUTPUT >

Connector	: RCA phono jack
Output impedance	: 150 ohms
Nominal level	: -10 dBu
Maximum level	: +2 dBu
Load impedance	: 10 k-ohms or greater

< PHONES OUTPUT >

Connector	: 1/4" stereo phone jack
Output impedance	: 100 ohms
Maximum level	: 50 mW @32 ohms

< DIGITAL INPUT/OUTPUT >

Connector	: Optical
Format	: S/P DIF (IEC958, EIAJ CP-1201)

< SCSI >

Connector	: D-sub 25 pin female
-----------	-----------------------

< MIDI IN/OUT >

Connector	: DIN 5 pin × 2
-----------	-----------------

< FOOT SW >

Connector	: 1/4" phone jack (use an optional PS-1)
-----------	---

< AC 9V IN >

Connector	: DIN 4 pin
-----------	-------------

■ Accessories : AC/AC power supply

■ Options : PS-1 pedal switch

Specifications and appearance are subject to change without notice for product improvement.

Functions added to the D8

Bouncing tracks 1–8

Now you can bounce a performance which was recorded on all eight tracks. Here's how to bounce the sound of tracks 1–8 to tracks 7 and 8 in stereo. (Refer to p.17)

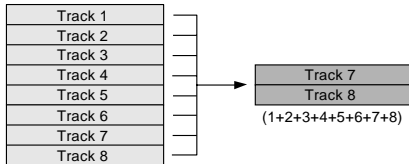

The data which had been in the bounce recording destination tracks 7 and 8 will be overwritten, so be sure to copy the song before you perform this operation.

Playback track and recording track settings

- 1 Press the [REC SELECT] key several times to select MASTER (indicator lit). With a setting of MASTER, you can use the master bus as the input for recording.
- 2 Press the [TRACK STATUS] keys for tracks 1–6 several times to set each one to **PLAY** (indicator lit green), to select these as playback tracks. Press tracks 7/8 [TRACK STATUS] key several times to select **REC (ANALOG)** (indicator blinking red), to select it as the recording track.

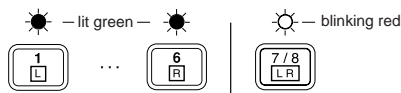

- 3 Rotate the [PAN] knobs of tracks 1–8 to place each track in the desired stereo location.

Adjusting the playback level and recording level

- 4 Press the [PLAY] key to begin playback.
- 5 Raise [CHANNEL] faders 1–8 to adjust the playback level of each track.
- 6 Raise the [MASTER] fader to adjust the recording level to tracks 7/8. The master level meter L/R will show the recording level.

Applying EQ and effects as you record

- 7 As desired, apply EQ and effects to tracks 1–8 as you record.

Starting and stopping recording

- 8 Press the [REC] key, and then press the [PLAY] key to begin recording. To stop recording, press the [STOP] key.

Playing back the recorded content (Playback)

- 9 Set tracks 7/8 to **PLAY** (indicator lit green) and the others to **MUTE**.

- 10 Move the current time location to a point earlier than where you begin recording, and playback to check the result.

If after checking the result, you decide to do the operation over again, press the [UNDO] key. Tracks 7 and 8 will return to the condition in which they were before the track bounce operation, so you can repeat the operation as many times as you like until you are happy with the results. At this time, if you simply record without remembering to press the [UNDO] key, the original data of tracks 7 and 8 will be lost, so we recommend that you make a copy of the song before performing the track bounce operation.