

# **A7GM-S 2.0 Motherboard**

## **User's Manual**

## Statement:

This manual is the intellectual property of Foxconn, Inc. Although the information in this manual may be changed or modified at any time, Foxconn does not obligate itself to inform the user of these changes.

## Trademark:

All trademarks are the property of their respective owners.

## Version:

User's Manual V1.0 for A7GM-S 2.0 motherboard.

P/N: 3A2216200-000-G

## Symbol description:



Caution: refers to important information that can help you to use motherboard better, and tells you how to avoid problems.



Warning: indicating a potential risk of hardware damage or physical injury may exist.



WEEE:

The use of this symbol indicates that this product may not be treated as household waste. By ensuring this product is disposed of correctly, you will help prevent potential negative consequences for the environment and human health, which could otherwise be caused by inappropriate waste handling of this product. For more detailed information about recycling of this product, please contact your local city office, your household waste disposal service or the shop where you purchased this product.

## More information:

If you want more information about our products, please visit Foxconn's website: <http://www.foxconnchannel.com>

© All rights reserved.

All trade names are registered trademarks of respective manufacturers listed.

All images are for reference only, please refer to the physical motherboard for specific features.

# Declaration of conformity



HON HAI PRECISION INDUSTRY COMPANY LTD  
66 , CHUNG SHAN RD., TU-CHENG INDUSTRIAL DISTRICT,  
TAIPEI HSIEN, TAIWAN, R.O.C.

declares that the product  
Motherboard A7GM-S 2.0

is in conformity with  
(reference to the specification under which conformity is declared in  
accordance with 89/336 EEC-EMC Directive)

- EN 55022:1998/A2:2003 Limits and methods of measurements of radio disturbance characteristics of information technology equipment
- EN 61000-3-2/:2000 Electromagnetic compatibility (EMC)  
Part 3: Limits  
Section 2: Limits for harmonic current emissions  
(equipment input current  $\leq 16A$  per phase)
- EN 61000-3-3/A1:2001 Electromagnetic compatibility (EMC)  
Part 3: Limits  
Section 2: Limits of voltage fluctuations and flicker in low voltage supply systems for equipment with rated current  $\leq 16A$
- EN 55024/A2:2003 Information technology equipment-Immunity characteristics limits and methods of measurement

Signature :

A handwritten signature in black ink that reads "James Liang". The signature is written in a cursive, flowing style.

Place / Date : TAIPEI/2008

Printed Name : James Liang

# Declaration of conformity



Trade Name: FOXCONN  
Model Name: A7GM-S 2.0  
Responsible Party: PCE Industry Inc.  
Address: 458 E. Lambert Rd.  
Fullerton, CA 92835  
Telephone: 714-738-8868  
Facsimile: 714-738-8838

Equipment Classification: FCC Class B Subassembly  
Type of Product: Motherboard  
Manufacturer: HON HAI PRECISION INDUSTRY  
COMPANY LTD  
Address: 66 , CHUNG SHAN RD., TU-CHENG  
INDUSTRIAL DISTRICT, TAIPEI HSIEN,  
TAIWAN, R.O.C.

## Supplementary Information:

This device complies with Part 15 of the FCC Rules. Operation is subject to the following two conditions : (1) this device may not cause harmful interference, and (2) this device must accept any interference received, including interference that may cause undesired operation.

Tested to comply with FCC standards.

Signature :

A handwritten signature in black ink, appearing to read 'James Liang'. The signature is written in a cursive, flowing style with a large, stylized 'L' at the end.

Date : 2008

## Installation Precautions



- Electrostatic discharge (ESD) is the sudden and momentary electric current that flows between two objects at different electrical potentials. Normally it comes out as a spark which will quickly damage your electronic equipment. Please wear an electrostatic discharge (ESD) wrist strap when handling components such as a motherboard, CPU or memory.

- Ensure that the DC power supply is turned off before installing or removing CPU, memory, expansion cards or other peripherals. It is recommended to unplug the AC power cord from the power supply outlet. Failure to unplug the power supply cord may result in serious damage to your system.



Please carefully read the following procedures to install your computer :

- It is suggested to select high-quality, certified fans in order to avoid damage to the motherboard and CPU due to high temperature. Never turn on the computer if the CPU fan is not properly installed.

- We cannot guarantee that your system can operate normally when your CPU is overclocked. Normal operation depends on the overclocking capacity of your device.

- If there is any, when connecting USB, audio, 1394a, RS232 COM, IrDA or S/PDIF cables to the internal connectors on the motherboard, make sure their pinouts are matching with the connectors on the motherboard. Incorrect connections might damage the motherboard.

- When handling the motherboard, avoid touching any metal leads or connectors.

- If there is a PCI Express x16 graphics card installed in your system, we recommend using a 24-pin ATX power supply to get the best performance.

- Before turning on the power, please make sure the power supply AC input voltage setting has been configured to the local standard.

- To prevent damage to the motherboard, do not allow screws to come in contact with the motherboard circuit or its components. Also, make sure there are no leftover screws or metal components placed on the motherboard or within the computer casing.

- If you are uncertain about any installation steps or have a problem related to the use of the product, please consult a certified computer technician.



# TABLE OF CONTENTS

## Chapter 1 Product Introduction

Product Specifications.....	2
Layout.....	4
Back Panel Connectors.....	5

## Chapter 2 Hardware Install

Install the CPU and CPU Cooler .....	8
Install the Memory .....	10
Install an Expansion Card .....	12
Install other Internal Connectors .....	13
Jumpers.....	17

## Chapter 3 BIOS Setup

Enter BIOS Setup.....	20
Main Menu.....	20
System Information .....	22
Advanced BIOS Features.....	24
Fox Central Control Unit.....	26
Advanced Chipset Features.....	31
Integrated Peripherals .....	35
Power Management Setup.....	40
PC Health Status.....	42
BIOS Security Features.....	43
Load Optimal Defaults.....	44
Save & Exit Setup .....	44
Exit Without Saving .....	44

## Chapter 4 CD Instruction

Utility CD content.....	46
Install driver and utility.....	47
FOX ONE	
Main Page.....	49
CPU Control.....	53
Frequency Control .....	55
Limit Setting .....	56
Voltage Control .....	58
Fan Control .....	59

FOX LiveUpdate	
Local Update .....	60
Online Update .....	62
Configure .....	65
About & Help .....	67
FOX LOGO .....	68
FOX DMI .....	69

## Chapter 5 RAID Configuration

RAID Configuration Introduction.....	72
FastBuild Driver.....	74
Create a RAID Driver Diskette .....	76
RAID Enable in BIOS .....	78
Select a RAID Array for Use .....	78
Install a New Windows XP.....	91
Setting Up a Non-Bootable RAID Array.....	95

## Technical Support :



Support

### Website :

<http://www.foxconnchannel.com>

### Support Website :

<http://www.foxconnsupport.com>

### Worldwide online contact Support :

<http://www.foxconnchannel.com/support/online.aspx>

### CPU, Memory, VGA Compatibility Supporting Website :

<http://www.foxconnchannel.com/product/Motherboards/compatibility.aspx>



Thank you for buying Foxconn A7GM-S 2.0 motherboard. Foxconn products are engineered to maximize computing power, providing only what you need for break-through performance.

With advanced overclocking capability and a range of connectivity features for today multi-media computing requirements, A7GM-S 2.0 enables you to unleash more power from your computer.

This chapter includes the following information:

- Product Specifications
- Layout
- Back Panel Connectors



# 1-1 Product Specifications

CPU	Support AMD socket AM2+ Phenom™ series processors Support AMD socket AM2 series processors : Athlon™ 64 FX / Athlon™ 64X2 Dual-Core / Athlon™ X2 Dual-Core / Athlon™ 64 / Sempron™
HyperTransport	2000/1600MT/s for AM2 CPU Up to 5200MT/s (HT3.0) for AM2+ CPU
Chipset	North Bridge: AMD 780G South Bridge: AMD SB700
Memory	4 x 240-pin DDR2 DIMM sockets Support up to 8GB of system memory Dual channel DDR2 1066(oc*)/800/667/533/400MHz architecture (oc*: overclocking)
Audio	Realtek 8-channel audio chip High Definition Audio 2/4/5.1/7.1-channel Support for S/PDIF Out Support Jack-Sensing function
LAN	Realtek Gigabit LAN chip
Expansion Slots	1 x PCI Express x16 slot 1 x PCI Express x1 slot 2 x PCI slots
Onboard Serial ATA	6 x SATA connectors 300MB/s data transfer rate Support hot plug and NCQ (Native Command Queuing )
USB	Support hot plug Support up to 10 x USB 2.0 ports (4 rear panel ports, 3 onboard USB headers supporting 6 extra ports) Supports USB 2.0 protocol up to 480Mb/s
Internal Connectors	1 x 24-pin ATX main power connector 1 x 4-pin ATX 12V power connector 1 x Floppy disk drive connector 1 x IDE connector 6 x SATA connectors 3 x USB 2.0 connectors (supporting 6 x USB devices) 1 x CPU fan header (4-pin) 1 x System fan header (4-pin) 1 x Front panel connector 1 x CD_IN connector 1 x Front Audio connector 1 x Speaker connector 1 x COM1 connector 1 x IrDA connector 1 x Chassis intrusion alarm header (INTR)

	1 x S/PDIF OUT connector 1 x TPM connector
Back Panel Connectors	1 x PS/2 keyboard port 1 x PS/2 mouse port 1 x VGA port 1 x HDMI port 1 x DVI-D port 4 x USB 2.0 ports 1 x RJ-45 LAN port 8-channel Audio ports
Hardware Monitor	System voltage detection CPU/System temperature detection CPU/System fan speed detection System voltage warning CPU/System overheating warning CPU/System fan speed control
PCI Express x1	Support 500MB/s (1GB/s concurrent) bandwidth Low power consumption and power management features
PCI Express x16	Support 8GB/s (16GB/s concurrent) bandwidth Low power consumption and power management features
Green Function	Support ACPI (Advanced Configuration and Power Interface) Support S0 (normal), S1 (power on suspend), S3 (suspend to RAM), S4 (suspend to disk), and S5 (soft - off)
Bundled Software	FOX ONE FOX LiveUpdate FOX LOGO FOX DMI
Operating System	Support for Microsoft® Windows® Vista/XP only
Form Factor	Micro ATX Form Factor, 9.6 inches x 9.6 inches (24.4cm x 24.4cm)



The chipset driver of this motherboard does not support Windows® 2000.

## 1-2 Layout

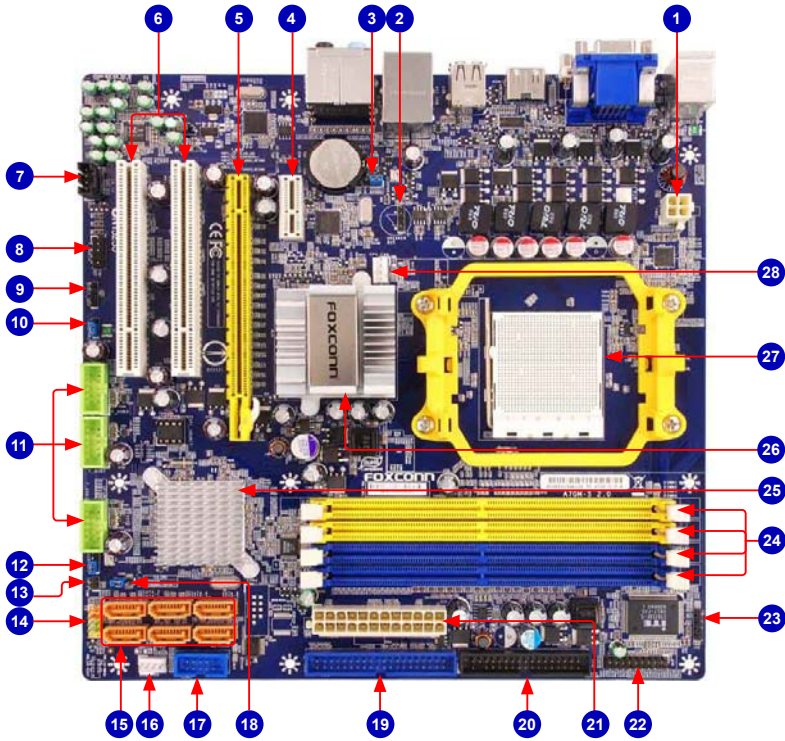

- |                                    |                                |
|------------------------------------|--------------------------------|
| 1. 4-pin ATX 12V Power Connector   | 15. SATA Connectors            |
| 2. Speaker Connector               | 16. System fan Header          |
| 3. USBPWR3 Jumper                  | 17. COM1 Connector             |
| 4. PCI Express x1 Slot             | 18. Clear CMOS Jumper          |
| 5. PCI Express x16 Slot            | 19. IDE Connector              |
| 6. PCI Slots                       | 20. Floppy Connector           |
| 7. CD_IN Connector                 | 21. 24-pin ATX Power Connector |
| 8. Front Audio Connector           | 22. TPM Connector              |
| 9. S/PDIF OUT Connector            | 23. IrDA Connector             |
| 10. USBPWR2 Jumper                 | 24. DDR2 DIMM Slots            |
| 11. Front USB Connectors           | 25. South Bridge: AMD SB700    |
| 12. USBPWR1 Jumper                 | 26. North Bridge: AMD 780G     |
| 13. Chassis Intrusion Alarm Header | 27. CPU Socket                 |
| 14. Front Panel Connector          | 28. CPU fan Header             |

Note : The above motherboard layout is for reference only, please refer to the physical motherboard for detail.

# 1-3 Back Panel Connectors

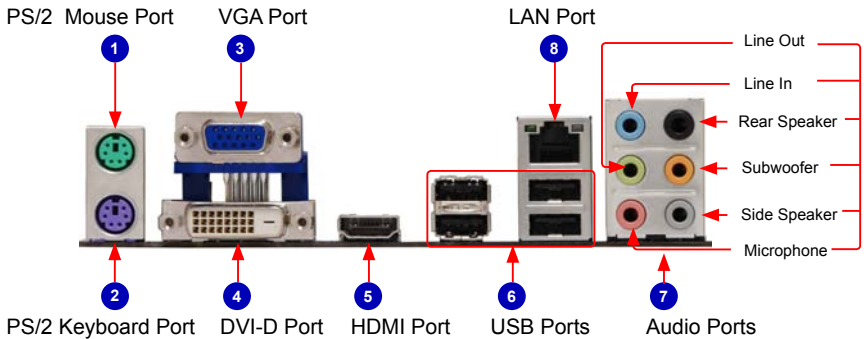

## 1. PS/2 Mouse Port

Use the upper port (green) to connect a PS/2 mouse.

## 2. PS/2 Keyboard Port

Use the lower port (purple) to connect a PS/2 keyboard.

## 3. VGA Port

To connect with external display devices, such as monitor or LCD display.

## 4. DVI-D Port

The DVI-D port supports DVI-D specification. Connect a monitor that supports DVI-D connection to this port.

## 5. HDMI Port

The HDMI (High-Definition Multimedia Interface) provides an all-digital audio/video interface to transmit the uncompressed audio/video signals and is HDCP compliant. Connect the HDMI audio/video device to this port. The HDMI Technology can support a maximum resolution of 1920x1080p but the actual resolutions supported depend on the monitor being used.

## 6. USB Ports

The USB port supports the USB 2.0/1.1 specification. Use this port for USB devices such as an USB keyboard/mouse, USB printer, USB flash drive and etc.

## 7. Audio Connectors

For the definition of each audio port, please refer to the table below :

Port	2-channel	4-channel	5.1-channel	7.1-channel
Blue	Line In	Line In	Line In	Line In
Green	Line Out	Front Speaker Out	Front Speaker Out	Front Speaker Out
Pink	Microphone In	Microphone In	Microphone In	Microphone In
Orange	-	-	Center/Subwoofer Out	Center/Subwoofer Out
Black	-	Rear Speaker Out	Rear Speaker Out	Rear Speaker Out
Grey	-	-	-	Side Speaker Out

## 8. RJ-45 LAN Port

The Ethernet LAN port provides Internet connection at up to 10/100/1000Mb/s data rate.

LAN Type	Left: Active		Right: Link	
	Status	Description	Status	Description
1000M	Off	No Link	Off	No Link
	Green Blinking	Data Activity	Off	10Mb/s Connection
			Green	100Mb/s Connection
			Orange	1000Mb/s Connection

Active  
LED      Link  
LED



# 2

This chapter introduces the hardware installation process, including the installation of the CPU, memory, power supply, slots, pin headers and the mounting of jumpers. Caution should be exercised during the installation of these modules. Please refer to the motherboard layout prior to any installation and read the contents in this chapter carefully.

This chapter includes the following information :

- Install the CPU and CPU Cooler
- Install the Memory
- Install an Expansion Card
- Install other Internal Connectors
- Jumpers



Please visit this website for more supporting information about CPU, Memory and VGA for your motherboard :

<http://www.foxconnchannel.com/product/Motherboards/compatibility.aspx>

## 2-1 Install the CPU and CPU Cooler



Read the following guidelines before you begin to install the CPU :

- Make sure that the motherboard supports the CPU.
- Always turn off the computer and unplug the power cord from the power supply before installing the CPU to prevent hardware damage.
- Locate the pin one of the CPU. The CPU cannot be inserted if oriented incorrectly.
- Apply an even and thin layer of thermal grease on the surface of the CPU.
- Do not turn on the computer if the CPU cooler is not installed, otherwise overheating and damage of the CPU may occur.
- Set the CPU host frequency in accordance with the CPU specifications. It is not recommended that the system bus frequency be set beyond hardware specifications since it does not meet the standard requirements for the peripherals. If you want to set the frequency beyond the standard specifications, please do so according to your hardware specifications including the CPU, graphics card, memory, hard drive, etc.

### Install the CPU

Locate the Pin-1 CPU triangle mark and the Pin-1 corner of the CPU socket.

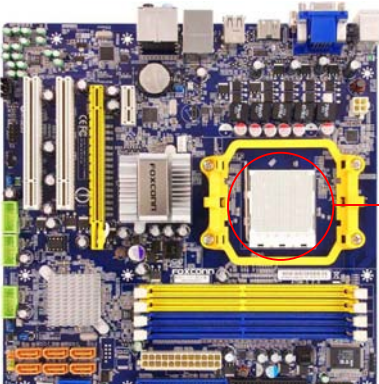

Pin-1 corner of the CPU socket



Pin-1 triangle marking of CPU



1. Release the CPU socket lever.



2. Align pin one of the CPU with the CPU socket, and gently put the CPU onto the socket.



- When CPU is properly seated, push the CPU socket lever back to its locked position.

### Install the CPU Cooler

Follow the steps below to correctly install the CPU cooler.

(The following procedures use Foxconn cooler as the example.)



- Apply and spread an even thermal grease on the surface of CPU.



- Buckle the heatsink firmly at one side of the stand.



- Buckle the heatsink at another side, and press the fastener lever down to tightly seat the cooler.



- Attach the 3-wire CPU cooler connector to the CPU fan header on the motherboard .



Use extreme care when removing the CPU cooler because the thermal grease may adhere to the CPU. Inadequately removing the CPU cooler may damage the CPU.



## 2-2 Install the Memory



Read the following guidelines before you begin to install the memory :

- Make sure that the motherboard supports the memory. It is recommended that memory of the same capacity, brand, speed, and chips be used.
- Always turn off the computer and unplug the power cord from the power outlet before installing the memory to prevent hardware damage.
- Memory modules have a foolproof design. A memory module can be installed in only one direction. If you are unable to insert the memory, switch the direction.

### Dual Channel Memory Configuration

This motherboard provides four DDR2 memory sockets and supports Dual Channel Technology. When memory is installed, the BIOS will automatically check the memory in your system.

Four DDR2 memory sockets are divided into two channels :

Channel 0 : DIMM1, DIMM3

Channel 1 : DIMM2, DIMM4

The combinations of DIMM modules are :

	DIMM1	DIMM2	DIMM3	DIMM4
Single Channel	DS/SS	-	-	-
Single Channel	DS/SS	-	DS/SS	-
Single Channel	-	-	DS/SS	-
Single Channel	-	DS/SS	-	DS/SS
Dual Channel	DS/SS	DS/SS	-	-
Dual Channel	-	-	DS/SS	DS/SS
Dual Channel	DS/SS	DS/SS	DS/SS	DS/SS

(DS : Dual Side, SS : Single Side, - : No Memory)



It is recommended that memory of the same capacity, brand, speed, and chips be used and please select dual channel first to achieve optimum performance.

## Installing a Memory



Before installing a memory module, make sure to turn off the computer and unplug the power cord from the power outlet to prevent damage to the memory module. Be sure to install DDR2 DIMMs on this motherboard.

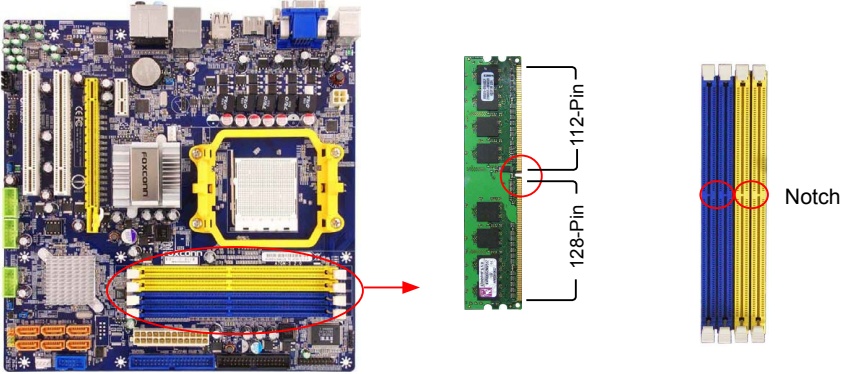

If you take a look at front side of memory module, it has asymmetric pin counts on both sides separated by a notch in the middle, so it can only fit in one direction. Follow the steps below to correctly install your memory modules into the sockets.

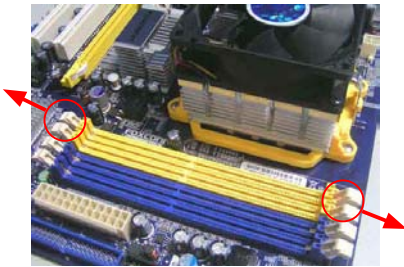

### Step 1:

Spread the clips at both ends of the memory socket. Place the memory module onto the socket, then put your fingers on top edge of the module, and push it down firmly and seat it vertically into the memory socket.

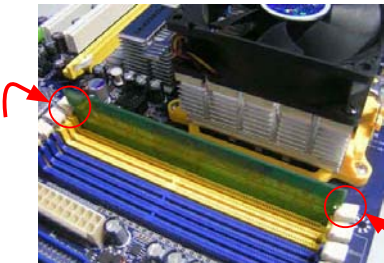

### Step 2:

The clips at both ends of the socket will snap into place when the memory module is securely inserted.

## 2-3 Install an Expansion Card



- Make sure the motherboard supports the expansion card. Carefully read the manual that came with your expansion card.
- Always turn off the computer and unplug the power cord from the power outlet before installing an expansion card to prevent hardware damage.

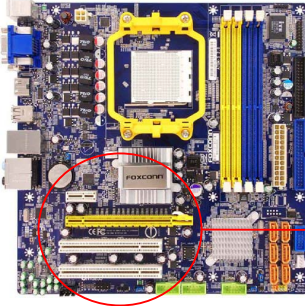

PCI Express x1



PCI Express x16



PCI



**Follow the steps below to correctly install your expansion card in the expansion slot.**

1. Locate an expansion slot that supports your card. Remove the metal slot cover from the chassis back panel.
2. Align the card with the slot, and press down on the card until it is fully seated in the slot.
3. Make sure the metal contacts on the card are completely inserted into the slot.
4. Secure the card's metal bracket to the chassis back panel with a screw.
5. After installing all expansion cards, replace the chassis cover.
6. Turn on your computer. If necessary, go to BIOS Setup to make any required BIOS changes for your expansion card(s).
7. Install the driver provided with the expansion card in your operating system.

### **Installing and Removing a PCI Express x16 Graphics Card :**



#### **• Installing a Graphics Card:**

Gently insert the graphics card into the PCI Express x16 slot. Make sure the graphics card is locked by the latch at the end of the PCI Express x16 slot.



#### **• Removing the Card:**

Push the latch at the end of the PCI Express x16 slot to release the card and then pull the card straight up from the slot.

## 2-4 Install other Internal Connectors

### Power Connectors

This motherboard uses an ATX power supply. In order not to damage any device, make sure all the devices have been installed properly before applying the power supply.

#### 24-pin ATX power connector : PWR1

PWR1 is the ATX power supply connector. Make sure that the power supply cable and pins are properly aligned with the connector on the motherboard. Firmly plug the power supply cable into the connector and make sure it is secure.

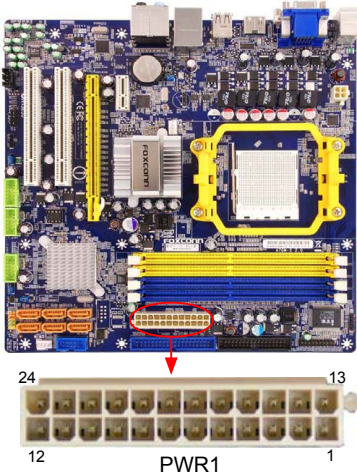

Pin #	Definition	Pin #	Definition
1	3.3V	13	3.3V
2	3.3V	14	-12V
3	GND	15	GND
4	+5V	16	PS_ON(Soft On/Off)
5	GND	17	GND
6	+5V	18	GND
7	GND	19	GND
8	Power Good	20	NC
9	+5V SB(Stand by +5V)	21	+5V
10	+12V	22	+5V
11	+12V	23	+5V
12	3.3V	24	GND

Pin No. 24



We recommend you using a 24-pin power supply. If you are using a 20-pin power supply, you need to align the ATX power connector according to the picture.

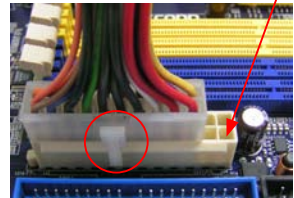

20-Pin Power

#### 4-pin ATX 12V Power Connector : PWR2

Connect the 4-pin ATX 12V power supply to PWR2 and provides power to the CPU.

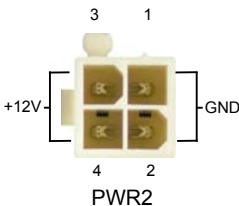

Pin #	Definition
1	GND
2	GND
3	+12V
4	+12V

## Front Panel Connector : FP1

This motherboard includes one connector for connecting the front panel switch and LED Indicators.

### Hard Disk LED Connector (HDD-LED)

Connect to the chassis front panel IDE indicator LED. It indicates the active status of the hard disks. This 2-pin connector is directional with +/- sign.

### Reset Switch (RESET-SW)

Attach the connector to the Reset switch on the front panel of the case; the system will restart when the switch is pressed.

### Power LED Connector (PWR-LED)

Connect to the power LED indicator on the front panel of the chassis. The Power LED indicates the system's status. When the system is in operation (S0 status), the LED is on. When the system gets into sleep mode (S1), the LED is blinking; When the system is in S3/S4 sleep state or power off mode (S5), the LED is off. This 2-pin connector is directional with +/- sign.

### Power Switch Connector (PWR-SW)

Connect to the power button on the front panel of the chassis. Push this switch allows the system to be turned on and off rather than using the power supply button.

## Serial ATA Connectors : SATA\_1/2/3/4/5/6

The Serial ATA connector is used to connect with SATA Hard Disk or CD devices which supporting this feature. The current Serial ATA II interface allows up to 300MB/s data transfer rate.

## COM Connector : COM1

This motherboard supports one serial RS232 COM port for legacy compatibility. User must purchase another RS232 cable with a 9-pin D-sub connector at one end to connect with the external RS232 device and another end with 10-pin female connector to connect with COM1 connector in the motherboard.

## IrDA Connector : IR

This connector supports infrared wireless transmitting and receiving device.

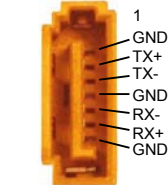
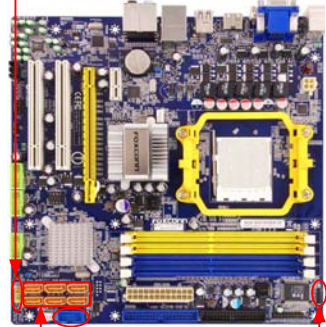
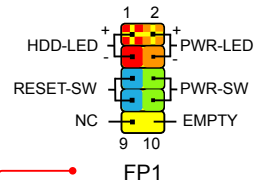

SATA\_1/2/3/4/5/6

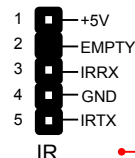
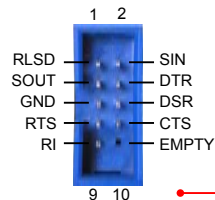

### Audio Connector : CD\_IN

CD\_IN is a Sony standard audio connector, it can be connected to a CD/DVD-ROM drive through a CD/DVD audio cable.

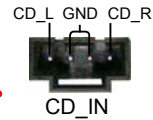

### Audio Connector : F\_AUDIO

The audio connector supports HD Audio standard. It provides the Front Audio output choice.



### S/PDIF OUT Connector : SPDIF\_OUT

The connector is used for S/PDIF output.

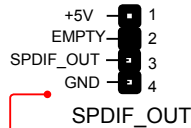

### USB Connectors : F\_USB1/2/3

In addition to the four USB ports on the rear panel, this product also provides three 10-pin USB headers on its motherboard. By connecting through USB cables with them, user can quickly expand another six USB ports on the front panel.

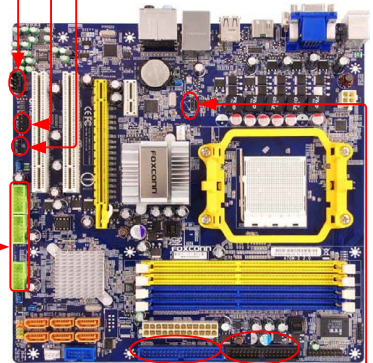
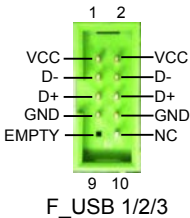

### IDE Connector : PIDE

With the provided Ultra DMA IDE ribbon cable, you can connect to any IDE type of hard disk and CD/DVD ROM/RW drive.

### Floppy Disk Drive Connector : FLOPPY

This motherboard includes a standard floppy disk drive (FDD) connector, supporting 360KB, 720KB, 1.2MB, 1.44MB, and 2.88MB FDDs.

### Speaker Connector : SPEAKER

The speaker connector is used to connect speaker of the chassis.



## Chassis Intrusion Alarm Header : INTR

The connector can be connected to a security switch on the chassis. The system can detect the chassis intrusion through the function of this connector. If eventually the chassis was closed, the system will send a message out.

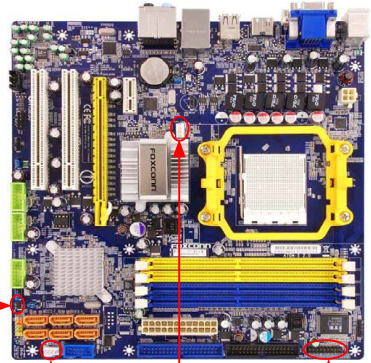
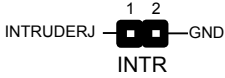

## Fan Headers : CPU\_FAN, SYS\_FAN

There are two main fan headers on this motherboard. The fan speed can be controlled and monitored in “PC Health Status” section of the BIOS Setup. These fans can be automatically turned off after the system enters S3, S4 and S5 sleeping states.

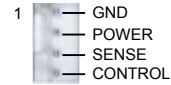

CPU\_FAN / SYS\_FAN

## TPM Connector : TPM

The TPM (Trusted Platform Module) provides the ability to the PC to run applications more secure and to make transactions and communication more trustworthy. To utilize this function, you should purchase additional device and install it.

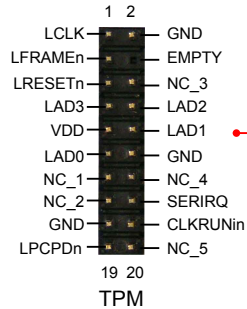

## 2-5 Jumpers

For some features needed, users can change the jumper settings on this motherboard to modify them. This section explains how to use the various functions of this motherboard by changing the jumper settings. Users should read the following content carefully prior to modifying any jumper setting.

### Description of Jumpers

1. For any jumper on this motherboard, pin 1 can be identified by the bold silkscreen next to it. However, in this manual, pin 1 is simply labeled as "1".
2. The following table explains different types of the jumper settings. "Closed" means placing a jumper cap on the two pins to temporarily short them. The shorting can also be done by touching two pins by a screwdriver for a few seconds, but using jumper cap is recommended. It can prevent hazardous ESD (Electrical Static Discharge) problem.

Jumper	Diagram	Definition	Description
1 □ □ □	1 ■ ■ □	1-2	Set Pin 1 and Pin 2 closed
	1 □ ■ ■	2-3	Set Pin 2 and Pin 3 closed

### Clear CMOS Jumper: CLR\_CMOS

The motherboard uses CMOS RAM to store the basic hardware information (such as BIOS data, date, time information, hardware password...etc.). Clear CMOS data is the fast way to go back to factory default when the BIOS settings were mistakenly modified.

The steps to clear CMOS data are :

1. Turn off the computer, unplug the power cord from the power outlet.
2. Remove jumper cap from pins 2-3, put it onto pins 1-2 to short them. This will clear CMOS data.
3. Return the setting to its original with pins 2-3 closed.
4. Plug in the power cord to your computer and turn it on.
5. Go to BIOS Setup to configure new system as described in next chapter.

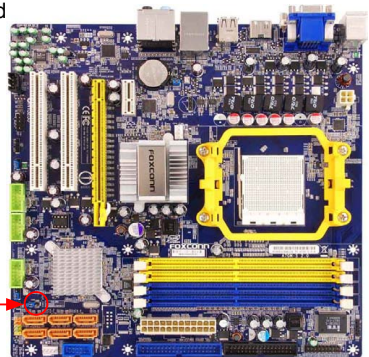
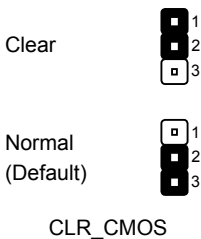

- Disconnect the power cable before adjusting the jumper settings.
- Do not clear the CMOS while the system is turned on.



## USB device wake-up Jumpers: USBPWR1 / 2 / 3

1. Set the jumper to pins 1-2 (+5V) to wake up the computer from S1 sleep mode using the connected USB devices.
2. Set the jumper to pins 2-3 (+5VSB) to wake up the computer from S3 and S4 sleep modes using the connected USB devices. At the same time, a corresponding setting must be set in BIOS as below:

Set -> "Power Management Setup" -> "Resume by USB Devices" to "Enabled".

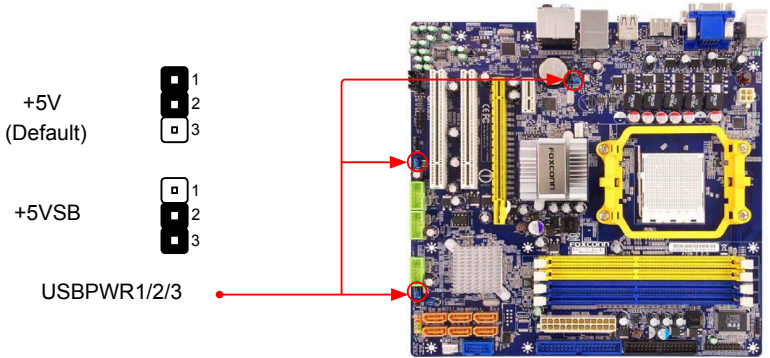

- USBPWR1/ USBPWR2 is for the internal USB connectors, USBPWR3 is for the rear USB ports.
- The USB device wake-up feature requires a power supply that can provide 500mA on +5VSB lead for each USB port; otherwise, the system will not power up.
- The total current consumed must not exceed the power supply capability (+5VSB) whether under normal condition or in sleep mode.

# 3

This chapter tells how to change system settings through the BIOS Setup menus. Detailed descriptions of the BIOS parameters are also provided.

You have to run the Setup Program when the following cases occur:

1. An error message appears on the screen during the system Power On Self Test (POST) process.
2. You want to change the default CMOS settings.

This chapter includes the following information :

- Enter BIOS Setup
- Main Menu
- System Information
- Advanced BIOS Features
- Fox Central Control Unit
- Advanced Chipset Features
- Integrated Peripherals
- Power Management Setup
- PC Health Status
- BIOS Security Features
- Load Optimal Defaults
- Save & Exit Setup
- Exit Without Saving



Since BIOS could be updated some other times, the BIOS information described in this manual is for reference only. We do not guarantee the content of this manual will remain consistent with the newly released BIOS at any given time in the future. Please visit our website for updated manual if it is available.

## Enter BIOS Setup

The BIOS is the communication bridge between hardware and software, correctly setting up the BIOS parameters is critical to maintain optimal system performance. Power on the computer, when the message "**Press <DEL> to enter Setup, <ESC> to boot menu**". appears at the bottom of the screen, you can press <DEL> key to enter SETUP.



We do not suggest that you change the default values in the BIOS Setup, and we shall not be responsible for any damage which resulted from the change you made.

## Main Menu

The main menu allows you to select from a list of setup functions together with two exit choices. Use the arrow keys to select a specific item and press <Enter> to go to the sub-menu. Each item in the main menu is explained below:

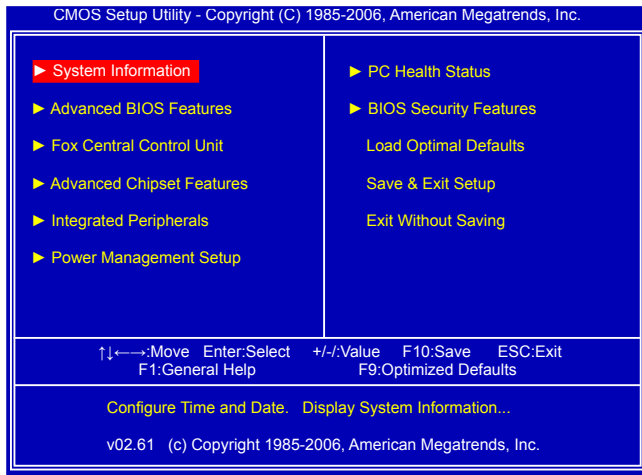

### ► System Information

It displays the basic system configuration, such as BIOS ID, CPU Name, memory size plus system date, time and Floppy drive. They all can be viewed or set up through this menu.

### ► Advanced BIOS Features

The advanced system features can be set up through this menu. There are boot up settings.

### ► Fox Central Control Unit

Some special proprietary features (such as overclocking) can be set up through this menu.

### ► Advanced Chipset Features

The values for the chipset can be changed through this menu, and the system performance can be optimized.

### ► Integrated Peripherals

All onboard peripherals can be set up through this menu. There are IDE devices, Super I/O devices such as Serial I/O and other USB devices... etc.

► **Power Management Setup**

All the items related with Green function features can be set up through this menu.

► **PC Health Status**

This setup enables you to read/change Fan speeds, and displays temperatures and voltages of your CPU/System.

► **BIOS Security Features**

The Supervisor/User password can be set up through this menu to prevent unauthorized use of your computer. If you set a password, the system will ask you to key in correct password before boot or access to Setup.

► **Load Optimal Defaults**

The optimal performance settings can be loaded through this menu. However, it may offer better performance in some ways (such as less I/O cards, less memory ...etc.), still, it may cause problem if you have more memory or I/O cards installed. It means, if your system loading is heavy, set to optimal default may sometimes come out an unstable system. What you need now is to adjust BIOS setting one by one, trial and error, to find out the best setting for your current system.

► **Save & Exit Setup**

Save setting values to CMOS and exit.

► **Exit Without Saving**

Do not change anything and exit the setup.

## System Information

This sub-menu is used to set up the standard BIOS features, such as the date, time, floppy drive and so on. Use the arrow up/down keys to select an item, then use the <+> or <-> keys to change the setting.

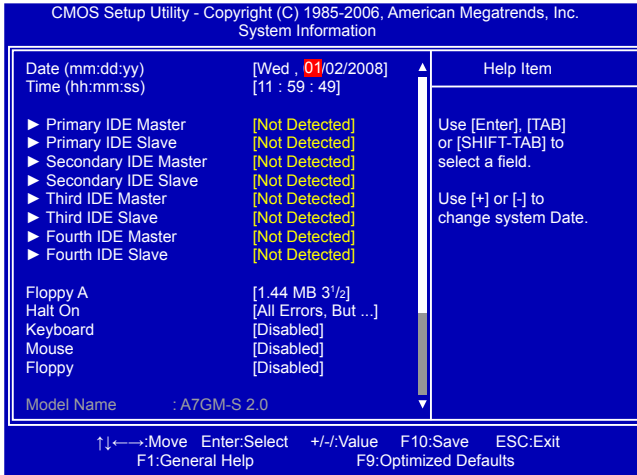

### ► Date (mm:dd:yy)

<weekday><month><date> <year> format.

Day—weekday from Sun. to Sat., this message is automatically displayed by BIOS (Read Only).

Month—month from 1 to 12.

Date—date from 1 to 31.

Year—year, set up by users.

Use [ENTER], [TAB] or [SHIFT-TAB] to select a field. Use [+] or [-] to input the value.

### ► Time (hh:mm:ss)

This item allows you to configure the desired time. Use [ENTER] to enter the setting, then use [TAB] to move forward a field. Use [+] or [-] to input the value.

The three fields of the setting are <hour> : <minute> : <second> respectively.

### ► Primary/Secondary/Third/Fourth IDE Master/Slave

While entering setup, BIOS automatically detects the presence of IDE devices. This item displays the drive information of IDE devices. Please refer to mapping table in next page.

### ► Floppy A

This option allows you to select which kind of the Floppy Disk Drive is installed in your system. It can be [Disabled], [360KB, 5 1/4"], [1.2MB, 5 1/4"], [720KB, 3 1/2"], [1.44MB, 3 1/2"] and [2.88 MB, 3 1/2"].

### ► Halt On

This category determines whether or not the computer will stop if an error is detected during powering up.

[All Errors]: All errors can result in system halt.

[All Errors But...]: All errors but keyboard or mouse or floppy can result in system halt. The halt condition can be enabled/disabled in the next three settings.

► **Keyboard**

The system boot will not stop for a keyboard error if you enabled this item.

► **Mouse**

The system boot will not stop for a mouse error if you enabled this item.

► **Floppy**

The system boot will not stop for a floppy error if you enabled this item.

► **Model Name**

Model name of this product.

► **BIOS ID / BIOS Version**

It displays the current BIOS ID/version. User can check this information and discuss with the field service people if a BIOS upgrade is needed.

► **CPU Name**

It displays the current CPU name.

► **Memory**

This item displays the current memory size. The size is depending on how many memory modules were installed in your system before powering on.

► **MAC Address**

This item shows the onboard LAN MAC address.

**Mapping Table :**

	With PATA IDE drives				Without PATA IDE drives				RAID/AHCI	
	Onchip SATA Channel Enabled				Onchip SATA Channel Disabled	Onchip SATA Channel Enabled				Onchip SATA Channel Disabled
	SATA Combined Mode Enabled		SATA Combined Mode Disabled			SATA Combined Mode Enabled		SATA Combined Mode Disabled		
	SATA as Secondary	SATA as Primary	SATA as Secondary	SATA as Primary		SATA as Secondary	SATA as Primary			
Primary IDE Master	IDE0	SATA 5	IDE0	-	SATA 5	-	SATA 5	-	SATA 5	IDE0
Primary IDE Slave	IDE1	SATA 6	IDE1	-	SATA 6	-	SATA 6	-	SATA 6	IDE1
Secondary IDE Master	SATA 5	IDE0	-	IDE0	IDE0	SATA 5	-	-	-	-
Secondary IDE Slave	SATA 6	IDE1	-	IDE1	IDE1	SATA 6	-	-	-	-
Third IDE Master	SATA 1	SATA 1	SATA 1	SATA 1	-	SATA 1	SATA 1	SATA 1	-	-
Third IDE Slave	SATA 3	SATA 3	SATA 3	SATA 3	-	SATA 3	SATA 3	SATA 3	-	-
Fourth IDE Master	SATA 2	SATA 2	SATA 2	SATA 2	-	SATA 2	SATA 2	SATA 2	-	-
Fourth IDE Slave	SATA 4	SATA 4	SATA 4	SATA 4	-	SATA 4	SATA 4	SATA 4	-	-

# Advanced BIOS Features

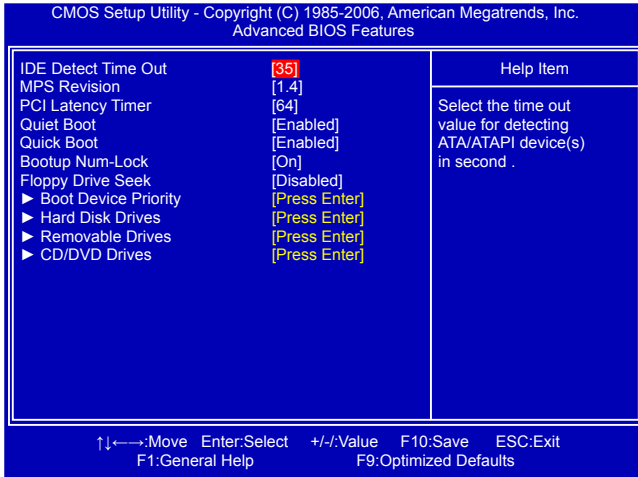

## ► IDE Detect Timer Out

This item is used to select the time out value for detecting ATA/ATAPI devices. If the checking time is over the set value, the system will skip it.

## ► MPS Revision

This feature is only applicable to multiprocessor motherboards as it specifies the version of the MPS that the motherboard will use. The MPS is a specification by which PC manufacturers design and build CPU architecture systems with two or more processors. MPS 1.1 was the original specification. MPS version 1.4 adds extended configuration tables for improved support of multiple PCI bus configurations and greater expandability in the future. In addition, MPS 1.4 introduces support for a secondary PCI bus without requiring a PCI bridge. If your operating system comes with support for MPS 1.4, you should keep the setting as the default 1.4. You also need to enable MPS 1.4 support if you need to make use of the secondary PCI bus on a motherboard that doesn't come with a PCI bridge. You should only leave it as 1.1 only if you are running an older operating system that only supports MPS 1.1.

## ► PCI Latency Timer

This item is used to set the PCI latency timer. The value is in unit of PCI cycle for PCI device latency timer register. Setting values are 32, 64, 96, 128, 160, 192, 224, 248.

This feature controls how long each PCI device can hold the bus before another takes over. The larger the value, the longer the PCI device can retain control of the bus. Low values for the PCI Latency Timer will reduce the effective PCI bandwidth while higher values means every PCI device will have to wait longer before they can get access to the bus, but when they do get access, they can conduct their transactions for a longer time. Normally, a default value of 64 cycles is set. Some PCI devices may not agree with longer latency times so if you start facing problems like stuttering sound or a less responsive system, reduce the latency. Higher values will actually reduce performance as too much time may be allocated to each PCI device to the disadvantage of other devices on the bus.

## ► Quiet Boot

This item is used to enable/disable the quiet boot.

[Disabled] : Displays the normal POST messages.

[Enabled] : Displays OEM customer logo instead of POST messages.

► **Quick Boot**

While Enabled, this option allows BIOS to skip certain tests while booting, this will shorten the time needed to boot the system.

► **Bootup Num-Lock**

This item defines if the keyboard Num Lock key is active when your system is started. The available settings are: On (default) and Off.

► **Floppy Drive Seek**

This item controls whether the BIOS will be checking for a floppy drive while booting up. If it cannot detect one (either due to improper configuration or physical unavailability), it will appear an error message. Disabling this function, then POST will not detect the floppy.

► **Boot Device Priority**

This option is used to select the priority for boot devices. After pressing <Enter>, you can select the device using the Up/Down arrow keys, and change the device priority using <+> or <->; you can exit this menu by pressing <Esc>.

► **Hard Disk Drives**

This option is used to specify the boot priority sequence from available hard disk drives.

► **Removable Drives**

This option is used to specify the boot priority sequence from available removable drives.

► **CD/DVD Drives**

This option is used to specify the boot priority sequence from available CD/DVD drives.



## Fox Central Control Unit

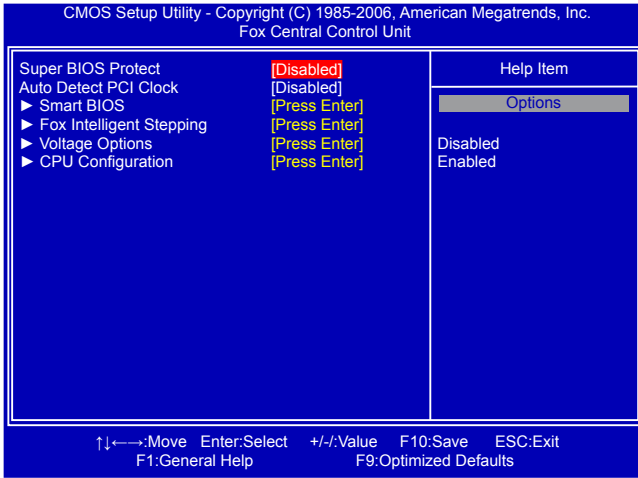

### ▶ Super BIOS Protect

To protect the system BIOS from virus attack, there is a BIOS write-protection mechanism provided. Super BIOS Protect function protects your BIOS from being affected by viruses, e.g. CIH.

### ▶ Auto Detect PCI Clock

This option is used to auto detect PCI slot. When enabled, the system will turn off clock of the empty PCI slot to reduce EMI (Electromagnetic Interference).

### ▶ Smart BIOS/Fox Intelligent Stepping/ Voltage Options/ CPU Configuration

Press <Enter> to go to its submenu.

## Smart BIOS

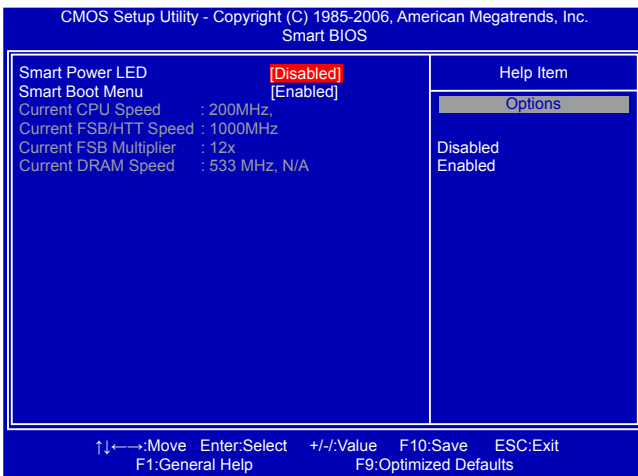

### ▶ Smart Power LED (Optional)

Smart Power LED is a feature built on your motherboard to indicate different states during Power On System Test (POST). The LED is located at the front panel, and it displays POST state by different long-short blinking intervals. You can always leave this state enabled.

System Status	Power LED Status	Stop Blinking Condition
Normal	Always On	Always On
No Memory	Continue blinking On (1sec.), Off (1sec.)	Reboot & Memory OK
No Display	Continue blinking On (2sec.), Off (2sec.)	Reboot & Display OK
Post Error Message	Quick blinking twice (1/3sec. On, 1/3sec. Off), one long On (1sec.), continuously.	Enter Setup or Skip
No CPU Fan	Continue blinking On (1/2sec.), Off (1/2sec.)	Reboot & Fan OK

### ► Smart Boot Menu

When PC starts, it will ask you to press [Del] key to enter setup or press [Esc] key to enter smart boot menu. If [Disabled] is selected, then pressing [Esc] has no function. This also prevents user without password trying to get into your computer through smart boot menu.

### ► Current CPU Speed

This item displays the current CPU speed.

### ► Current FSB/HTT Speed

This item displays the current Front Side Bus speed.

### ► Current CPU Multiplier (Appears only when CPU supports)

This item displays the current CPU Ratio.

### ► Current DRAM Speed

This item displays the current DRAM speed, in dual channels.

## Fox Intelligent Stepping

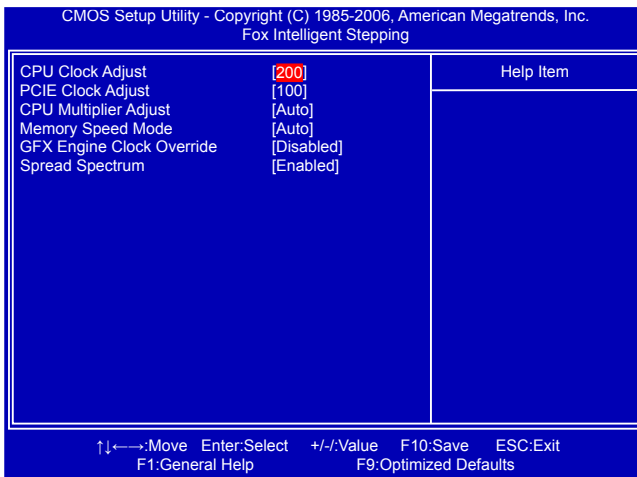

### ► CPU Clock Adjust

This option is used to adjust the CPU clock.

### ► PCIE Clock Adjust

This option is used to adjust the speed of PCI Express slot. It may enhance the graphics card speed.

► **CPU Multiplier Adjust (Appears only when CPU supports)**

This option is used to adjust the CPU Clock Ratio. Multiply CPU clock with this ratio, you can get the CPU speed. Increase this ratio may overclock your CPU. This option will be displayed only if your CPU is supporting this feature.

► **Memory Speed Mode**

This item is used to enable/disable provision of DRAM timing by SPD device. The SerialPresence Detect (SPD) device is a small EEPROM chip, mounted on a DDR2 memory module. It contains important information about the module's speed, size, addressing mode and various other parameters, so that the motherboard memory controller (chipset) can better access the memory device. Select [Auto] for SPD enable mode. Select [Limit], the DRAM speed will not exceed the specified value listed in the "Memory Speed Adjust" item. If SPD value is faster than "Memory Speed Adjust" value, it will run at the specified "Memory Speed Adjust" speed. Otherwise, SPD value is selected. Select [Manual], then DRAM speed is manually selected according to the set value of "Memory Speed Adjust".

► **GFX Engine Clock Override**

This item allows you to enable/disable GFX Engine Clock Override support.

► **Spread Spectrum**

If you enabled this function, it can significantly reduce the EMI (Electromagnetic Interference) generated by the system, so to comply with FCC regulation. But if overclocking is activated, you had better disable it.

## Voltage Options

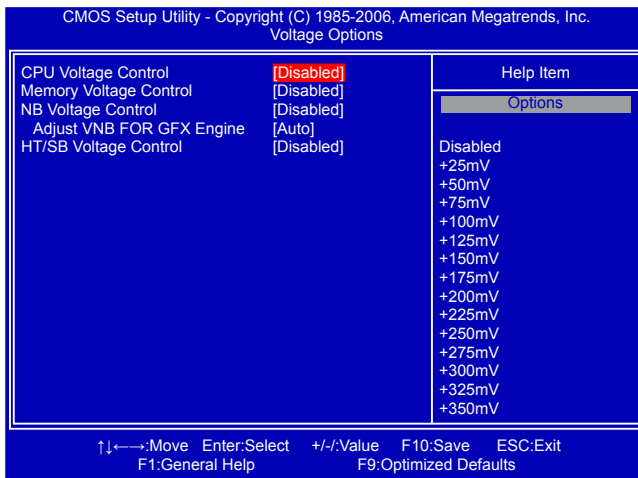

► **CPU Voltage Control**

This option is used to change the CPU voltage in a step of 25mV. The voltage can be incremented from +25mV to +775mV.

► **Memory Voltage Control**

This option is used to change the DRAM voltage in a step of 50mV. The voltage can be

incremented from +50mV to +600mV.

### ► NB Voltage Control

This option is used to change the NB voltage in a step of 30mV. The voltage can be incremented from +30mV to +360mV.

### ► Adjust VNB FOR GFX Engine

This option is used to adjust the NB voltage. Setting value: [Auto]; [Manual].

### ► HT/SB Voltage Control

This option is used to change the HT/SB voltage in a step of 30mV. The voltage can be incremented from +30mV to +360mV.

## CPU Configuration

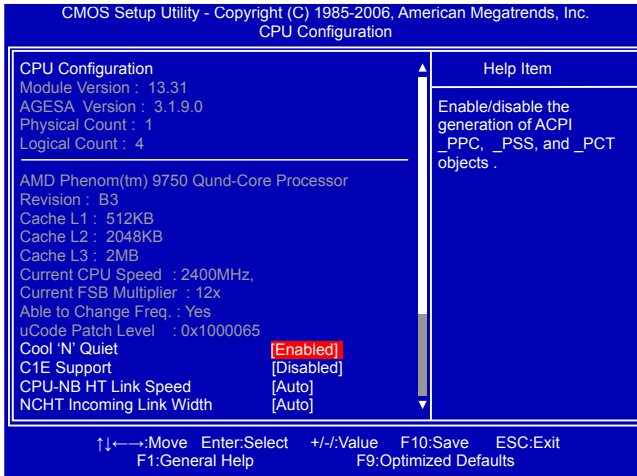

This menu shows most of the CPU specifications.

### ► Cool 'N' Quiet (Appears only when CPU supports)

This option helps lowering down the CPU frequency and voltage when system is idling. When the CPU speed is slowing down, the temperature will drop as well.

### ► C1E Support (Appears only when CPU supports)

C1E represents Enhanced HALT State. It is a feature which CPU uses to reduce power consumption when in halt state. C1E drops the CPU's multiplier and voltage to lower levels when a HLT (halt) command is issued. This item is used to enable/disable the C1E support.

### ► CPU-NB HT Link Speed

HT stands for HyperTransport bus. The CPU<->NB HT Speed option controls the physical speed of the CPU to Northbridge HT link using multipliers ranging 1x to 13x. The physical speed of the link is determined by multiplying the CPU clock with the CPU<->NB HT Speed setting.

### ► NCHT Incoming Link Width / NCHT Outgoing Link Width

The coherency refers to the caching of memory, and the HT links between processors are coherent HT links as the HT protocol includes messages for managing the cache protocol. Other (non processor-processor) HT links are Non-Coherent HT links, as they do not have memory cache.

The HyperTransport link width and frequency are initialized between the adjacent coherent and/or noncoherent HyperTransport technology devices during the reset sequence. It is highly recommended to set to [Auto] for overall performance.

# Advanced Chipset Features

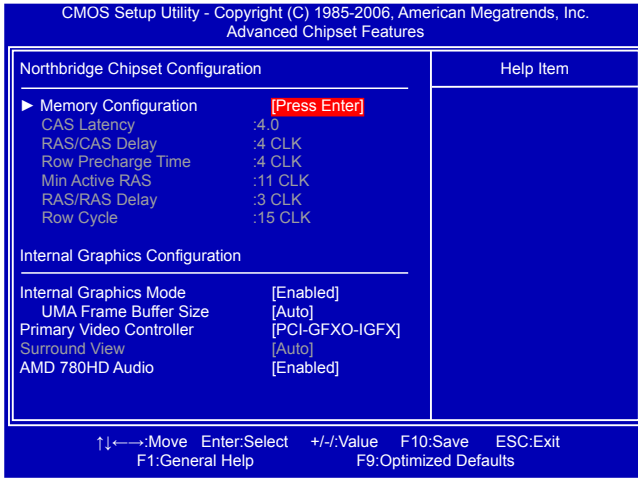

## ▶ Memory Configuration

Press <Enter> to go to its submenu.

The following six items display the DRAM timing values.

## ▶ CAS Latency

This item shows the CAS latency. The CAS Latency is the number of clock cycles that elapse from the time the request for data is sent to the actual memory location until the data is transmitted from the module.

## ▶ RAS / CAS Delay

This item displays a delay time (in clock cycles) between the CAS and RAS strobe signals.

## ▶ Row Precharge Time

This item shows the number of clock cycles taken between issuing of the precharge command and the active command. The DRAM row precharge time is in unit of clock cycle.

## ▶ Min Active RAS

Displays the number of clock cycles taken between a bank active command and issuing of the precharge command.

## ▶ RAS / RAS Delay

This item shows a delay time (in clock cycles) between the RAS and RAS strobe signals.

## ▶ Row Cycle

This item displays the minimum timing interval between successive active commands to the same bank. The row cycle time is in unit of clock cycle.

## ▶ Internal Graphics Mode

Enable/Disable the integrated UMA graphics controller.

## ▶ UMA Frame Buffer Size

Allocates system memory for use as video memory to ensure the most efficient use of available resources for maximum 2D/3D graphics performance.

This is a memory allocation method addition to the Unified Memory Architecture (UMA)

concept, wherein a static amount of page-locked graphics memory is allocated during driver initialization. This fixed amount of memory will provide the user with a guaranteed graphics memory at all times, and will no longer be available to the OS.

### ► Primary Video Controller

This item is used to select which graphics controller is used as the primary boot device.

### ► Surround View

Surround View is the ATI technology that provides multi-graphics controller display capability for both the ATI PCIe-based graphics card and the ATI integrated graphics processor (IGP). Enabling SurroundView does not impact display modes (resolution and color depth) or performance. The display mode of each output is controlled independently by the graphics controller connected to it.

1. When using a non-ATI PCI Express (PCIe) graphics card, Surround View is not supported. The integrated graphics processor (IGP) is automatically disabled, and the system memory allocated to the IGP is freed for other use.
2. When installing an ATI RV610 or RV630 PCIe graphics card, Surround View is [Auto] by default, and the PCIe graphics card is the default first display device. Enabling SurroundView in the BIOS enables the integrated UMA graphics controller, which in turn makes available up to two additional graphics outputs. When enabling the integrated UMA graphics controller, system memory will be reallocated.

### ► AMD 780HD Audio

This item is used to set whether the HD Audio controller is enabled through the HDMI port on the rear panel.

## Memory Configuration

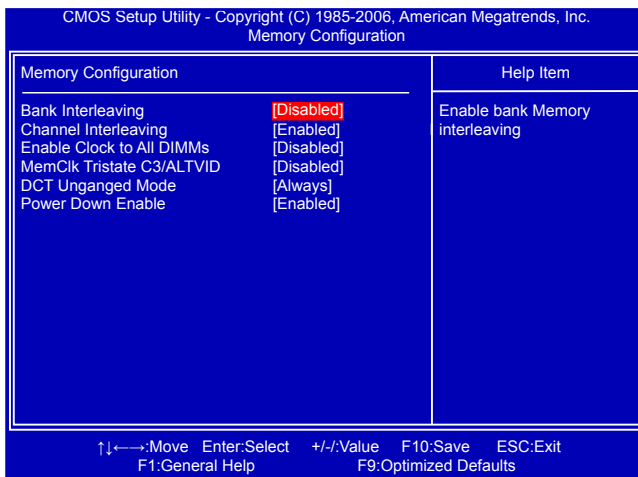

### ► Bank Interleaving

Interleaving allows banks of SDRAM to alternate their refresh and access cycles. One bank will undergo its refresh cycle while another is being accessed. This improves memory

performance by masking the refresh cycles of each memory bank.

However, bank interleaving only works if the addresses requested consecutively are not in the same bank.

### ► Channel Interleaving

Dual channel (Interleaved) mode offers the highest throughput for real world applications. Dual channel mode is enabled when the installed memory capacities of both DIMM channels are equal. If different speed DIMMs are used between channels, the slowest memory timing will be used.

To achieve Dual Channel Interleaving mode, the following conditions must be met:

Matched DIMM configuration in each channel

Same Density (128MB, 256MB, 512MB, etc.)

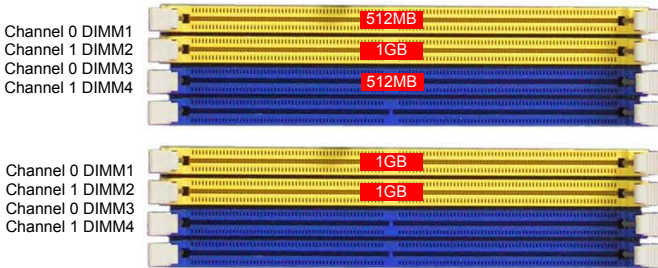

Matched in both Channel 0 and Channel 1 memory channels

### ► Enable Clock to All DIMMs

This setting is to control EMI.

When disabled, the system will turn off clock on the empty DIMM slots and to reduce EMI (Electro-Magnetic Interference).

### ► MemCik Tristate C3/ALTVID

Enables the DDR memory clocks to be tristated when alternate VID mode is enabled.

### ► DCT Unganged Mode

DCT stands for DRAM Controller.

Ganged refers to the use of both DRAM controllers within a memory controller acting in concert to access memory. For a description of ganged (128-bit DRAM data width) and unganged (64-bit DRAM data width) DRAM modes :

Ganged channels (DDR2) :

- DCT channels A and B can be ganged as a single logical 128-bit DIMM.
- Offers highest DDR2 bandwidth.
- Requires both DIMMs in a logical pair to have identical size and timing parameters, both DCTs programmed identically.

Unganged channels

- DCT channels A and B operate as two completely independent 64-bit channels (both channels operate at the same frequency).
- Reduce DRAM page conflicts – more concurrent open dram pages .
- Better bus efficiency.

Burst lengths supported



When both DCTs are enabled in ungangled mode, BIOS must initialize the frequency of each DCT in order.

► **Power Down Enable**

When power down mode is enabled, if all pages of the DRAMs associated with a CKE pin are closed, then these parts are placed in power down mode.

# Integrated Peripherals

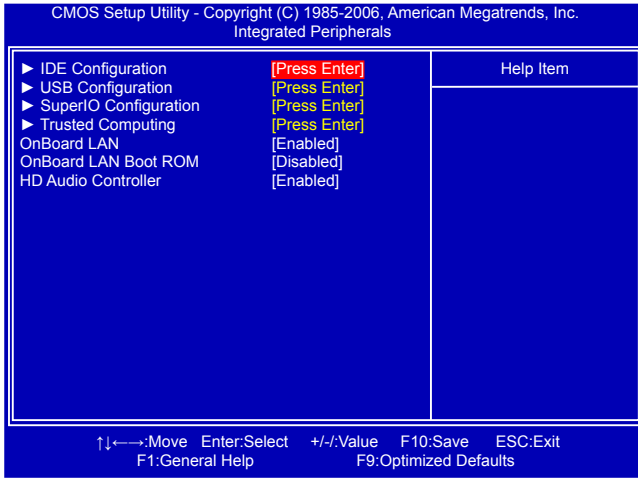

## ▶ IDE Configuration / USB Configuration / SuperIO Configuration / Trusted Computing

Press <Enter> to go to relative submenu.

## ▶ OnBoard LAN

This item is used to enable or disable the onboard LAN controller.

## ▶ OnBoard LAN Boot ROM

This item is used to enable or disable the onboard LAN boot optional ROM. A LAN boot ROM lets you set up a diskless workstation on the network. By installing a boot ROM in the network board, you can enable a client PC system on the network to be booted remotely.

## ▶ HD Audio Controller

This item is used to enable or disable the HD Audio controller.

# IDE Configuration

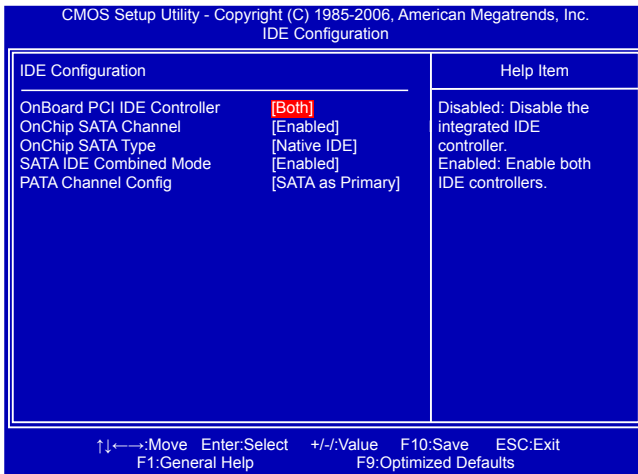

## ▶ OnBoard PCI IDE Controller

[Disabled]: Disable the integrated IDE controller.

[Enabled]: Enable both IDE controllers.

► **OnChip SATA Channel**

[Disabled] : Disable SATA ports 1, 2, 3, 4.

[Enabled] : Enable SATA ports 1, 2, 3, 4.

► **OnChip SATA Type**

This item is used to set the operating mode of your SATA ports.

Options : [Native IDE]; [RAID]; [AHCI]; [Legacy IDE].

**[Native IDE]** - This configures the SATA ports to support native IDE mode.

**[RAID]** - When you enable RAID, it means all your SATA drives must also support AHCI.

**[AHCI]** - The Advanced Host Controller Interface (AHCI) specification describes the register level interface for a Host Controller for Serial ATA. The specification includes a description of the hardware/software interface between system software and the host controller hardware. AHCI provides more advanced features including SATA features, but some SATA drives may not support AHCI, unless they are labeled with AHCI support in its specification.

If your motherboard supporting AHCI, and you have a SATA device, which also supports AHCI, then you can select IDE option to have fair performance (only PATA, SATA level), or you can select AHCI to get its best performance.

**[Legacy IDE]** - This configures the SATA ports to support legacy IDE mode which is running for old Windows system.

► **SATA IDE Combined Mode**

[Disabled] : Disable SATA ports 5, 6.

[Enabled] : SATA ports 5, 6 are used to simulate two additional IDE ports. You can select from PATA or SATA as the Primary IDE through the next "Combined Mode Option" setting. Four drives are displayed as IDE Channel 0 Master/Slave and IDE Channel 1 Master/Slave in "System Information" menu.

► **PATA Channel Config**

When "SATA IDE Combined Mode" is enabled, you can choose :

[SATA as Primary] : Set SATA ports 5, 6 to function as the Primary IDE.

[SATA as Secondary] : Set SATA ports 5, 6 to function as the Secondary IDE.

	With PATA IDE drives					Without PATA IDE drives				RAID/ AHCI
	Onchip SATA Channel Enabled				Onchip SATA Channel Disabled	Onchip SATA Channel Enabled			Onchip SATA Channel Disabled	
	SATA Combined Mode Enabled		SATA Combined Mode Disabled			SATA Combined Mode Enabled		SATA Com- bined Mode Disabled		
	SATA as Secondary	SATA as Primary	SATA as Secondary	SATA as Primary		SATA as Secondary	SATA as Primary			
Primary IDE Master	IDE0	SATA 5	IDE0	-	SATA 5	-	SATA 5	-	SATA 5	IDE0
Primary IDE Slave	IDE1	SATA 6	IDE1	-	SATA 6	-	SATA 6	-	SATA 6	IDE1
Secondary IDE Master	SATA 5	IDE0	-	IDE0	IDE0	SATA 5	-	-	-	-
Secondary IDE Slave	SATA 6	IDE1	-	IDE1	IDE1	SATA 6	-	-	-	-
Third IDE Master	SATA 1	SATA 1	SATA 1	SATA 1	-	SATA 1	SATA 1	SATA 1	-	-
Third IDE Slave	SATA 3	SATA 3	SATA 3	SATA 3	-	SATA 3	SATA 3	SATA 3	-	-
Fourth IDE Master	SATA 2	SATA 2	SATA 2	SATA 2	-	SATA 2	SATA 2	SATA 2	-	-
Fourth IDE Slave	SATA 4	SATA 4	SATA 4	SATA 4	-	SATA 4	SATA 4	SATA 4	-	-

## USB Configuration

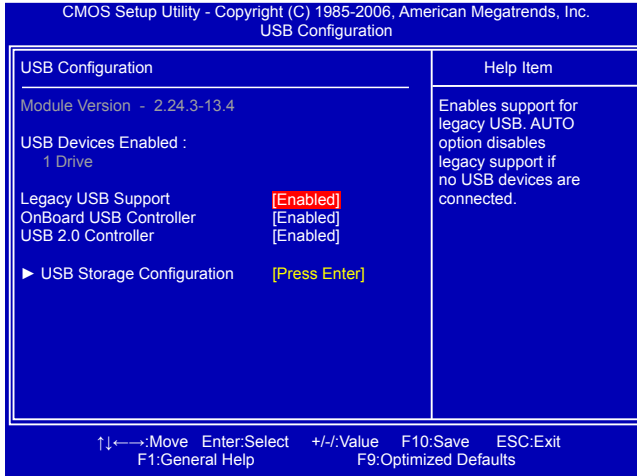

### ► Legacy USB Support

This item is used to enable the support for USB devices on legacy OS. If you have a USB keyboard or mouse, set to auto or enabled.

### ► OnBoard USB Controller

This item is used to enable or disable the onboard USB controller.

### ► USB 2.0 Controller

This item is used to enable or disabled the enhanced host controller interface for USB.

If USB devices are connected to the computer, the following item will appear:

### ► USB Storage Configuration

After pressing <Enter>, you can set the reset delay for the USB mass storage device. There are many different emulation types of this USB device, such as floppy, hard disk and CDROM can be selected.

# SuperIO Configuration

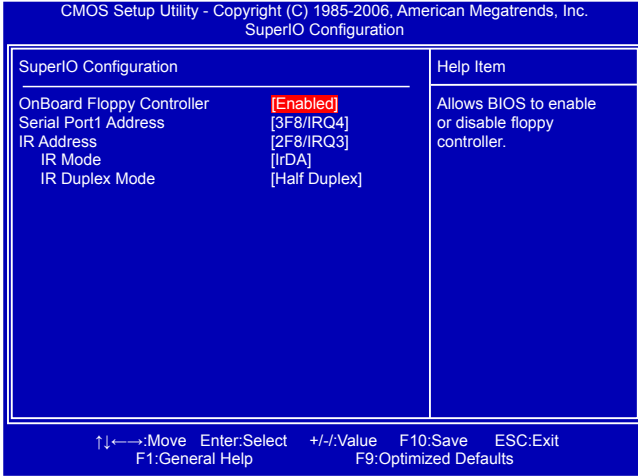

## ► OnBoard Floppy Controller

This item is used to enable/disable Floppy Controller.

## ► Serial Port1 Address

This item is used to assign the I/O address and interrupt request (IRQ) for the onboard serial port 1.

## ► IR Address

This item is used to assign the I/O address and interrupt request (IRQ) for the IR port.

## ► IR Mode

This item is used to set the IR mode. The available settings are :

[IrDA] : An IrDA device for maximum 115200 bit/s.

[ASK IR] : A faster IrDA for 1152000 bit/s.

## ► IR Duplex Mode

This item enables you to determine the infrared function of the onboard infrared chip.

# Trusted Computing

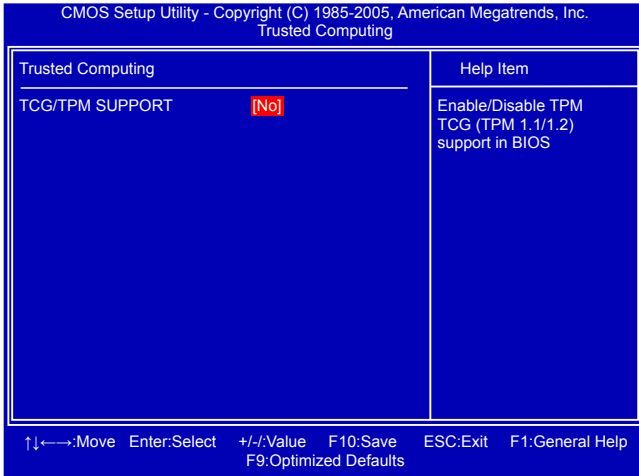

## ► TCG/TPM SUPPORT

Trusted Computing Group (TCG) members develop and promote open, vendor-neutral, industry standard specifications for trusted computing building blocks and software interfaces across multiple platforms

TPM (Trusted Platform Module) is a specification promoted by TCG. A Trusted Platform Module offers facilities for secure generation of cryptographic keys.

The TPM Work Group is chartered to create the Trusted Platform Module (TPM) specification. The definition of the TPM architecture comes from the TC and the TPM Work Group defines the implementation of that architecture. Work group members should have a working knowledge of security in relation to the design and usage of cryptographic modules. Members should also have a working knowledge of cryptographic techniques including public-key cryptography, cryptographic algorithms and protocols.

This item is used to enable/disable the function of TCG/TPM support.

# Power Management Setup

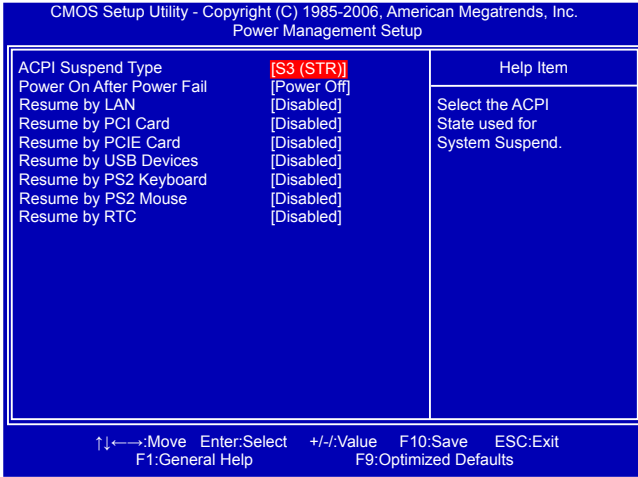

ACPI (Advanced Configuration and Power Interface) is an open industry standard interfaces enabling OS-directed configuration, power management, and thermal management of mobile, desktop, and server platforms. It defines five sleeping states, they are :

- S1 - The S1 sleeping state is a low wake latency sleeping state. In this state, no system context is lost (CPU or chip set) and hardware maintains all system context. (also called **Power On Suspend**)
- S2 - The S2 sleeping state is a low wake latency sleeping state. This state is similar to the S1 sleeping state except that the CPU and system cache context is lost (the OS is responsible for maintaining the caches and CPU context). Control starts from the processor's reset vector after the wake event.
- S3 - The S3 sleeping state is a low wake latency sleeping state where all system context is lost except system memory. CPU, cache, and chip set context are lost in this state. Hardware maintains memory context and restores some CPU and L2 configuration context. Control starts from the processor's reset vector after the wake event. (also called **Suspend to RAM**)
- S4 - The S4 sleeping state is the lowest power, longest wake latency sleeping state supported by ACPI. In order to reduce power to a minimum, it is assumed that the hardware platform has powered off all devices. Platform context is maintained. (also called **Suspend to Disk**)
- S5 - The S5 state is similar to the S4 state except that the OS does not save any context. The system is in the "soft" off state and requires a complete boot when it wakes. Software uses a different state value to distinguish between the S5 state and the S4 state to allow for initial boot operations within the BIOS to distinguish whether or not the boot is going to wake from a saved memory image.

▶ **ACPI Suspend Type**

This item is used to set the energy saving mode of the ACPI function. When you select “S1 (POS)” mode, the power is always on and computer can be resumed at any time. When you select “S3 (STR)” mode, the power will be down after a period of time. The status of the computer before it entering STR will be saved in memory, and the computer can quickly return to previous state when the STR function wakes.

▶ **Power On After Power Fail**

This item is used to set which state the PC will take with when it resumes after an AC power loss.

▶ **Resume by LAN**

This item is used to enable/disable the LAN to generate a wake up.

▶ **Resume by PCI Card**

This item is used to enable/disable the PCI card to generate a wake up.

▶ **Resume by PCIE Card**

This item is used to enable/disable the PCIE card to generate a wake up.

▶ **Resume by USB Devices**

This item is used to enable/disable the USB keyboard and mouse to generate a wake up.

▶ **Resume by PS2 Keyboard**

This item is used to enable/disable the PS2 keyboard to generate a wake up.

▶ **Resume by PS2 Mouse**

This item is used to enable/disable the PS2 mouse to generate a wake up.

▶ **Resume by RTC**

This item is used to enable/disable RTC alarm event to generate a wake up.

RTC is system real time clock.

▶ **RTC Alarm Date(Days)**

When Resume by RTC is enabled, select a specific date to generate a wake up.

▶ **RTC Alarm Time (HH : MM : SS)**

When Resume by RTC is enabled, select a specific time to generate a wake up.



## PC Health Status

CMOS Setup Utility - Copyright (C) 1985-2006, American Megatrends, Inc. PC Health Status		
Warning Temperature	[Disabled]	Help Item
Shut Down Temperature	[Disabled]	
Case Open Warning	[Disabled]	Options
CPU Temperature	:63 °C/145 °F	Disabled
System Temperature	:35 °C/95 °F	50 °C/122 °F
CPU Fan Speed	:3729 RPM	55 °C/131 °F
System Fan Speed	-N/A	60 °C/140 °F
CPU Core	:1.232 V	65 °C/149 °F
DRAM Voltage	:1.888 V	70 °C/158 °F
+3.3V	:3.424 V	75 °C/167 °F
+12.0V	:12.032 V	80 °C/176 °F
+1.1V	:1.032 V	85 °C/185 °F
CPU Smart Fan Function	[Disabled]	90 °C/194 °F
System Smart Fan Function	[Disabled]	

↑↓←→:Move Enter:Select +/-:Value F10:Save ESC:Exit  
F1:General Help F9:Optimized Defaults

### ► Warning Temperature

This option is used to set the warning temperature for the system. When the temperature of CPU is higher than the set value, the motherboard will send out warning information.

### ► Shut Down Temperature

This item is used to set the system temperature upper limit. When the temperature exceeds the set value, the system will shut down automatically.

This function works only when your operating system is supporting ACPI.

### ► Case Open Warning

This item is used to enable or disable case open warning function.

### ► CPU/System Temperature

The CPU/System temperature are automatically detected and displayed by the system.

### ► CPU Fan/System Fan Speed

The CPU fan/System fan speed are automatically detected and displayed by the system.

### ► CPU Core/DRAM Voltage/NB Voltage/+ 3.3V/+12.0V/+1.1V

The current voltages are automatically detected and displayed by the system.

### ► CPU Smart Fan Function / System Smart Fan Function

This option is used to enable or disable smart fan function.

### ► Start PWM Temperature

It allows you set a temperature value from which smart fan starts its operation.

### ► Start PWM Value

It allows you to set an initial PWM value to drive the fan when the temperature reaches Start value and smart fan begins its operation. The higher PWM value can achieve the faster fan speed.

### ► Slope PWM Value

The slope controls the PWM value being stepped up or down versus temperature changes.

# BIOS Security Features

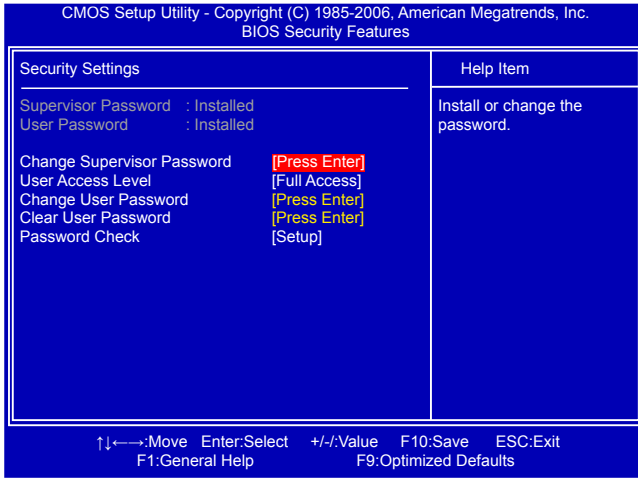

## ► Change Supervisor Password

This item is used to install or change supervisor password. After you input Supervisor password, it then will ask you to input user password optionally.

If you have installed the Supervisor Password, the following items will appear:



## ► User Access Level

This item is used to set user access level.

The available settings are:

[No Access]: Prevent user access to the setup utility.

[View Only]: Allow access to the setup utility but the fields can not be changed.

[Limited]: Allow only limited fields to be changed, such as date and time.

[Full Access]: Allow any field to be changed except the supervisor password.

## ► Change User Password

This item is used to install or change user password.

## ► Clear User Password

This item will be displayed only when a User Password was set before. It is used to clear the user password.

## ► Password Check

When it is set to [Setup], a password is required to enter the BIOS setup; select [Always], a password is required not only to enter BIOS setup, but also on each boot of your PC.

## Load Optimal Defaults

Optimal defaults are the best settings of this motherboard. Always load the Optimal defaults after updating the BIOS or after clearing the CMOS values.

Select this option and press Enter, it will pop out a dialogue box to let you load the defaults. Select <OK> and then press <Enter> to load the defaults. Select <Cancel> and press <Enter>, it will not load.

By this default, BIOS have set the optimal performance parameters of system to improve the performances of system components. But if the optimal performance parameters to be set cannot be supported by your hardware devices (for example, too many expansion cards were installed), the system might fail to work.

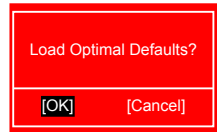

## Save & Exit Setup

When you select this option and press <Enter>, a message will be displayed in the center of the screen:

Select [OK] to save your changes to CMOS and exit the program, select [Cancel] or <ESC> to return to the main menu.

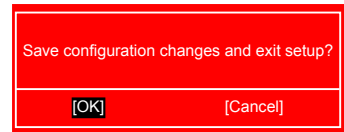

## Exit Without Saving

If you select this option and press <Enter>, the following message will be displayed in the center of the screen:

Select [OK] to exit CMOS without saving your modifications, select [Cancel] or <ESC> to return to the main menu.

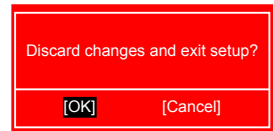

# 4

The utility CD that came with the motherboard contains useful software and several utility drivers that enhance the motherboard features.

This chapter includes the following information:

- Utility CD content
- Install driver and utility
- FOX ONE
- FOX LiveUpdate
- FOX LOGO
- FOX DMI

Note : Because each module is independent, so the section number will be reorganized and unique to each module, please understand.



- Depending on the package content you may have, there are two types of driver CD :
- 1). One DVD : The installation steps are as described in this chapter.
  - 2). Two CDs : The installation steps are mostly the same as described in this chapter, the only difference is Adobe Acrobat Reader and Norton Utility are put in the second CD and you need to install them separately.

## Utility CD content

This motherboard comes with two CDs or one DVD . You can simply put it into your CD/DVD-ROM drive, and the main menu will be displayed on your PC screen to guide you how to install.

### 1. Install Driver

Use these options to install all the drivers for your system. You should install the drivers in order, and you need to restart your computer after all the drivers have been installed.

- A. AMD Chipset Driver
- B. Realtek HDA Audio Driver
- C. Realtek 811X LAN Driver
- D. AMD RAID Driver (It appears when the "OnChip SATA Type" setting in BIOS is set to [RAID])
- E. ATI HDMI Audio Driver

### 2. Software Utilities

Use these options to install additional software programs. FOX ONE is a very powerful user interface program which allows you to change your system setting without going to BIOS. Some auto features help user to improve (or overclock) your system without being a computer literate.

- A. FOX ONE
- B. FOX LiveUpdate
- C. FOX LOGO
- D. FOX DMI
- E. Microsoft DirectX 9.0
- F. Adobe Acrobat Reader
- G. Norton Internet Security
- H. AMD RAID Utility

# Install driver and utility

## 1. Install Driver

You must click "AMD Chipset Driver" to install it first. After that, you can click "One Click Setup" to install all the other drivers left, or you can click on each individual driver to install it manually.

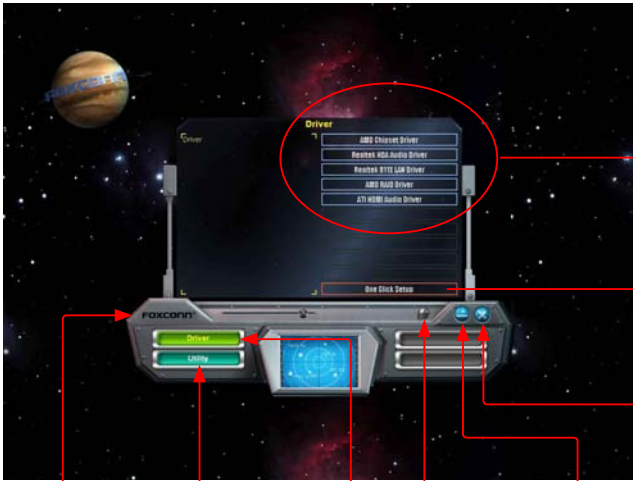

Manual Installation Step by Step

Automatic Installation by One Click.

Exit the program

Click to visit Foxconn's website

Select to Install Utilities

Select to Install Drivers

Browse CD

Drop to System Tray

## 2. Install Utility

You can select the specific utility to install.



# FOX ONE

FOX ONE is a powerful utility for easily modifying system settings. It also allows users to monitor various temperature values, voltage values, frequencies and fan speeds at any time.

With FOX ONE, you can :

- Modify system performance settings, such as the CPU and memory bus speeds, CPU voltages, fan speeds, and other system performance options.
- Monitor hardware temperatures, voltages, frequencies and fan speeds.



Depending on hardware support, voltage monitoring and Fox Intelligent Stepping features are optional and only supported in some models. If the option is selectable, it also means the feature is supported.

- Voltage Monitoring is supported only in FOX ONE Premium & Deluxe products.
- Fox Intelligent Stepping is supported only in FOX ONE Deluxe products.

Supporting Operating Systems :

- Windows 2000
- Windows XP (32-bit and 64-bit)
- Windows 2003 (32-bit and 64-bit)
- Windows Vista (32-bit and 64-bit)

## Using FOX ONE :

The very first time you run FOX ONE, F.I.S. Calibration function (FOX Intelligent Stepping) will require you to calibrate the CPU's loading. Click "OK" to proceed and start the Utility. F.I.S. is a feature of FOX ONE, which can automatically adjust your CPU clock based on your current system loading.

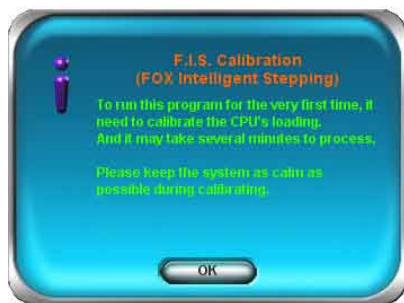

Before you running the FOX ONE program, the system parameters (such as CPU clock, voltage...etc.) are controlled by BIOS settings. After you run FOX ONE, it will take over, and the controlling right will be transferred to FOX ONE. Later, if you exit FOX ONE, then BIOS control will be back again.

# 1. Main Page

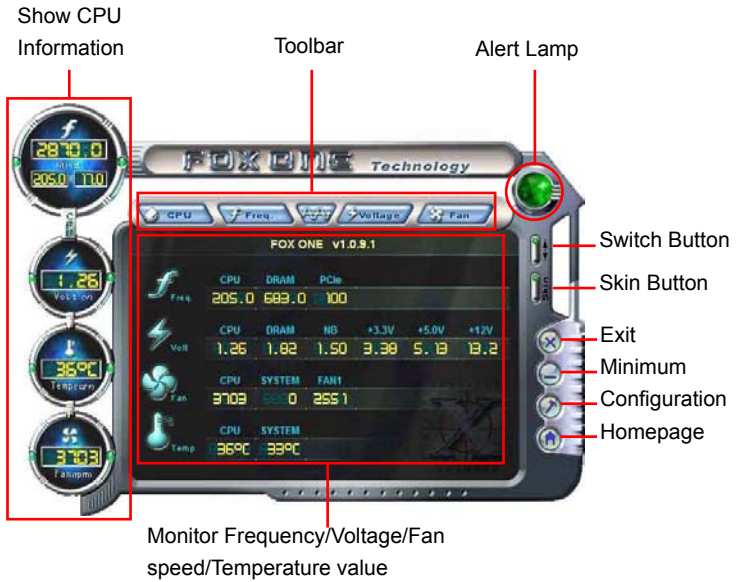

## Toolbar

Use the toolbar to navigate to other pages.

## Alert Lamp

When the system is in healthy state, the color of alert lamp is green. When the system is in abnormal state, the alert lamp color is red.

## Switch Button

Click this button, it will simplify the whole FOX ONE control panel to a smaller information bar (i.e. Simple Mode) as depicted below, you can drag this bar to any place on your screen to help you monitoring system status.

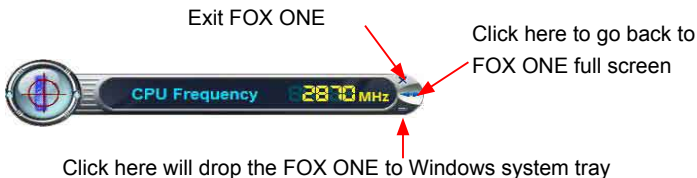



## Skin Button

There are more choices of FOX ONE screen panels. Click this button, you can select your favorite skin (FOX ONE Panel).

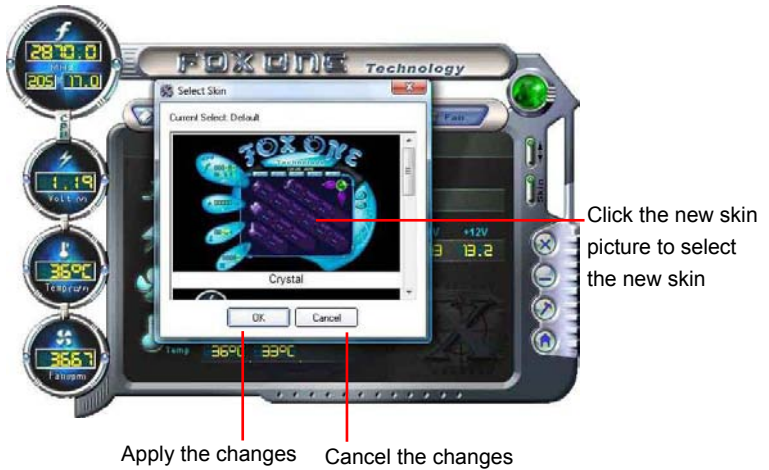

## Exit

Click this button to exit the program.

## Minimum

Click this button to drop the FOX ONE to Windows system tray located at the lower right corner of your screen.



## Homepage

Click this button to visit Foxconn motherboard website :  
<http://www.foxconnchannel.com>

## Configuration

This menu allows you to configure :

### 1). Monitor interval (ms) :

This is to define the interval of different messages of system settings which are to be displayed on Simple Mode screen. Minimum value is 1 second.



### 2). Simple Mode :

To select which message of system settings are to be displayed in the Simple Mode. Messages such as CPU frequency, voltage...etc., they can be displayed one by one in Simple Mode.



### 3). F.I.S. Calibration (FOX Intelligent Stepping, Optional)

This function will re-calibrate the CPU's loading, and it may take several minutes to proceed. The FOX ONE calibration process will apply different loadings to your CPU, record PWM IC voltage together with the CPU clock running at these loadings, so it can define and estimate within a particular range of system loading, what the CPU clock should be.

Step 1 : Click Calibration icon, a message pops out to ask for continue. Select Yes.



Step 2 : After data is collected, it will ask you to restart your computer now.



Later on, when the FOX ONE program is activated, and F.I.S. feature (in CPU Page) is also enabled, FOX ONE will automatically adjust your CPU clock according to your system loadings. (Loadings are like Power Gaming, Data Mining...etc.)

## 2. CPU Page - CPU Control

This page lets you select (or overclock) CPU clock to meet the current performance level of the system. The fastest and suitable CPU clock running for current system can be calculated by FOX ONE automatically or manually input by yourselves.

### Manual :

You can press the up/down button to adjust your CPU clock.

### Auto :

Click this button to let FOX ONE check the highest CPU clock you can use. System will raise the CPU clock step by step until it hangs, you can then push the RESET button on your PC panel to restart the system. When system restarts, run FOX ONE again, it will display a recommended highest CPU clock for you, click <Yes> to apply it.

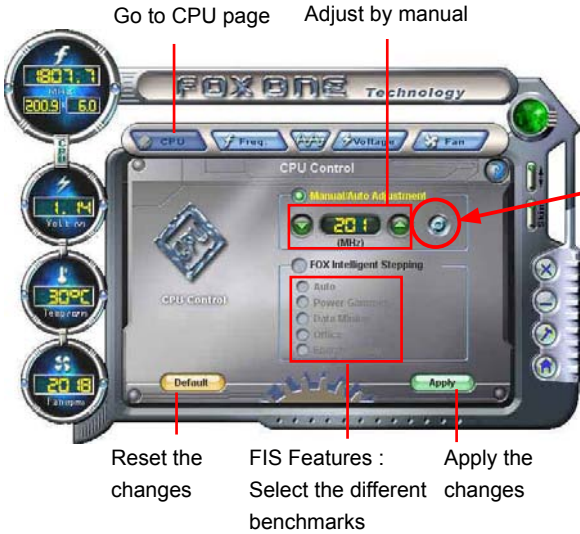

Press Auto button to let FOX ONE check the highest CPU clock you can use.



A message informs you to push RESET button later if the system hangs finally. Click Yes to continue.



You can see the system is raising CPU clock until the system hangs. Push RESET button on the front panel of your system to restart the computer.



Run FOX ONE program again, it will inform you the previous test found that 255MHz is the recommended CPU clock for your system. Click Yes to apply it to your system.



Now, your system is running at a CPU clock of 255MHz.

## FOX Intelligent Stepping (F.I.S., Optional)

Select FOX Intelligent Stepping will allow your system to automatically adjust your CPU clock rate based on different system loadings. For example, if you select Power Gaming, CPU clock will be driven to run at its maximum speed. While in Energy Saving, CPU will lower down its speed to a minimum. The four benchmarks - Power Gaming, Data Mining, Office and Energy Saving, the references of their system loading were calculated and defined in the FIS Calibration option of Configuration menu. Select Auto, CPU will automatically adjust its clock according to current system loading.



## 3. Frequency Page - Frequency Control

This page lets you set memory and PCI Express frequencies by manual.

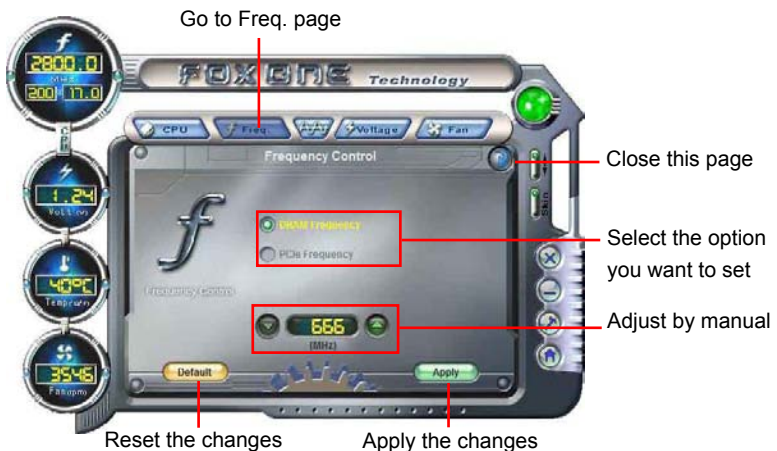

## 4. Limit Setting

### 4.1 Limit Setting - CPU Temperature

This page lets you to set CPU high limit temperature and enable the alert function.

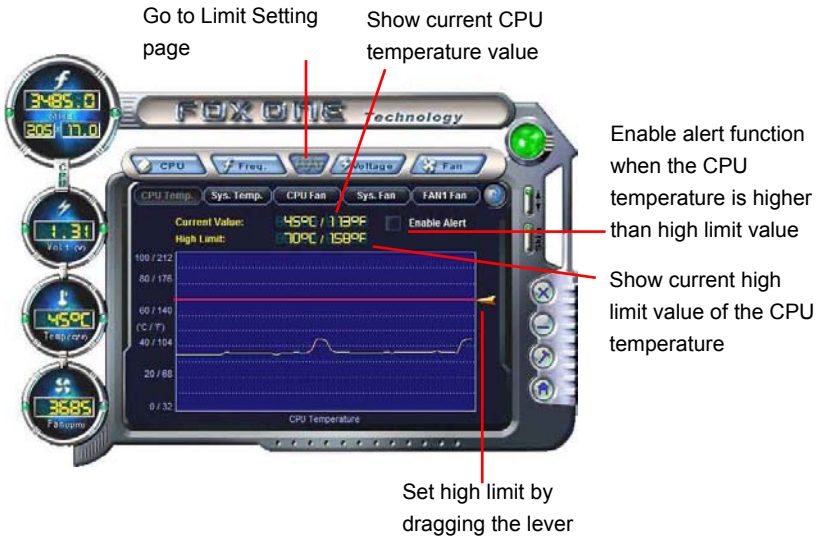

### 4.2 Limit Setting - System Temperature

This page lets you to set system high limit temperature and enable the alert function.

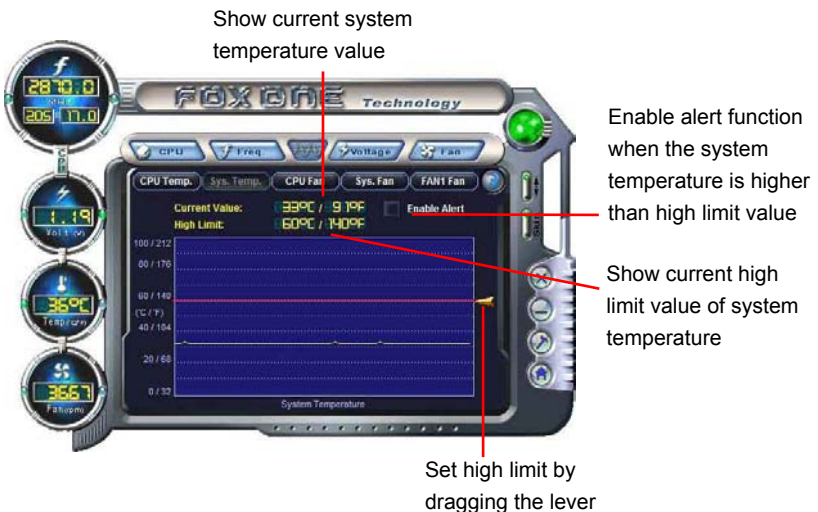

### 4.3 Limit Setting - CPU Fan

This page lets you to set CPU fan low limit rpm and enable the alert function.

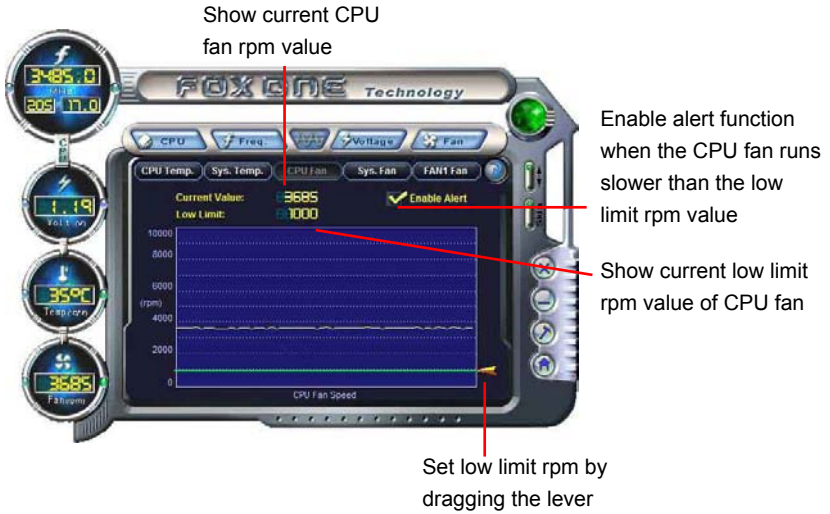

### 4.4 Limit Setting - System Fan

This page lets you to set system fan low limit rpm and enable the alert function.

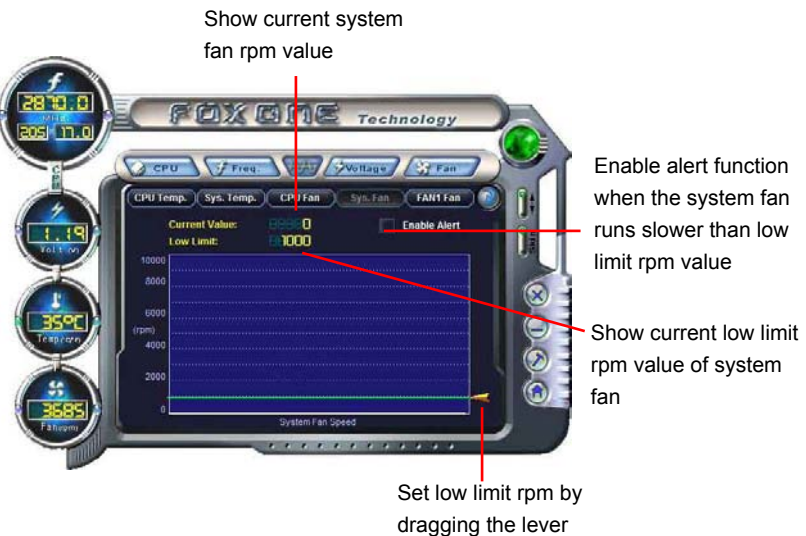



#### 4.5 Limit Setting - FAN1 Fan (Optional)

This page lets you to set FAN1 fan low limit rpm and enable the alert function.

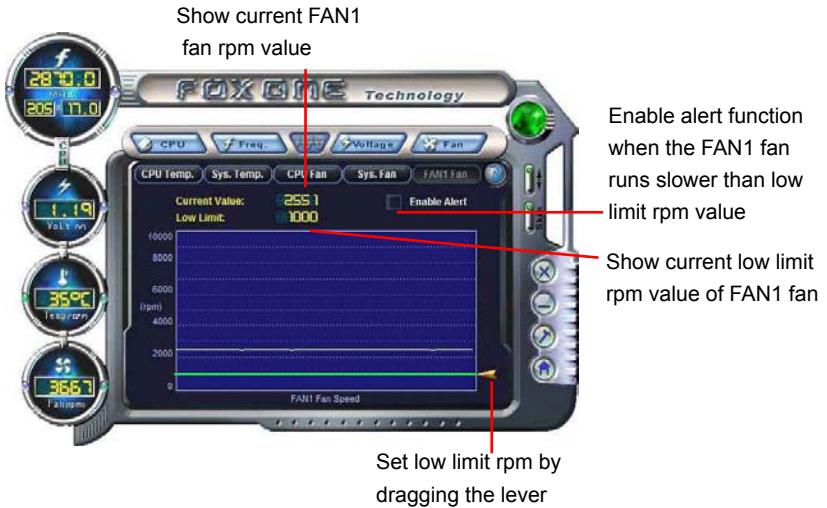

#### 5. Voltage Page - Voltage Control (Optional)

This page lets you set CPU voltage, memory voltage and North Bridge voltage manually. CPU voltage can be stepped up/down by a unit of 12.5mV, while memory is 0.05V/step, and North Bridge is 0.04V/step.

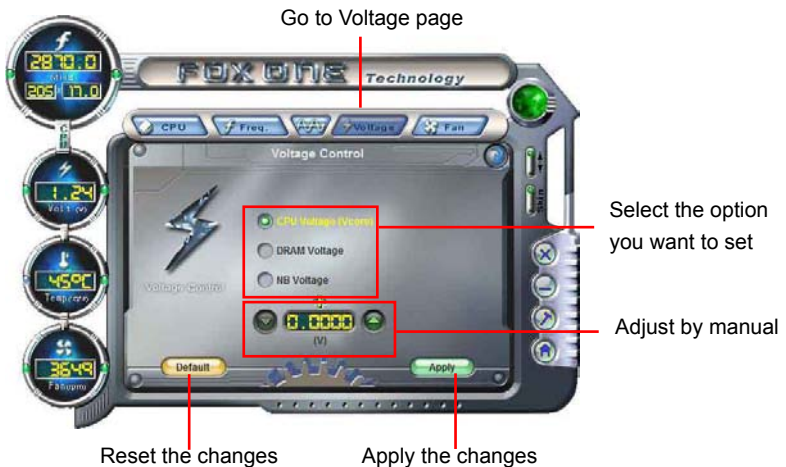

## 6. Fan Page - Fan Control

This page lets you enable Smart Fan function or set the fan speed by manual. When Smart Fan is selected, you must use a 4-pin CPU cooler in your system.

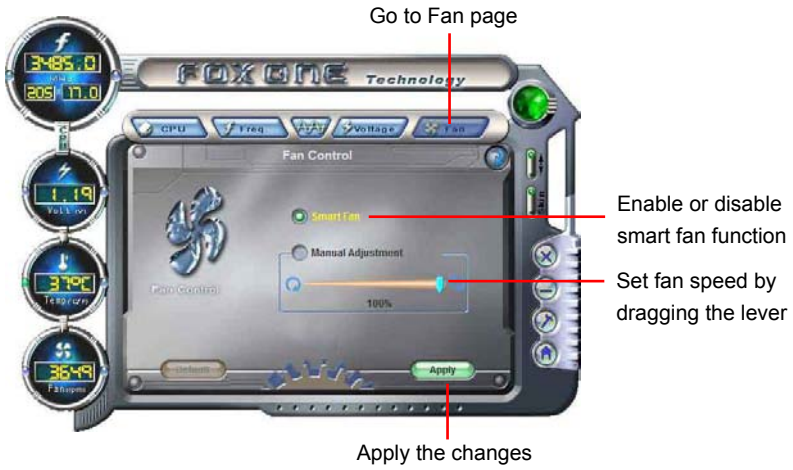

# FOX LiveUpdate

FOX LiveUpdate is a useful utility to backup and update your system BIOS, drivers and utilities by local or online.

Supporting Operating Systems :

- Windows 2000
- Windows XP (32-bit and 64-bit)
- Windows 2003 (32-bit and 64-bit)
- Windows Vista (32-bit and 64-bit)

## Using FOX LiveUpdate :

### 1. Local Update

#### 1-1 Local Update - BIOS Information

This page lets you know your system BIOS information.

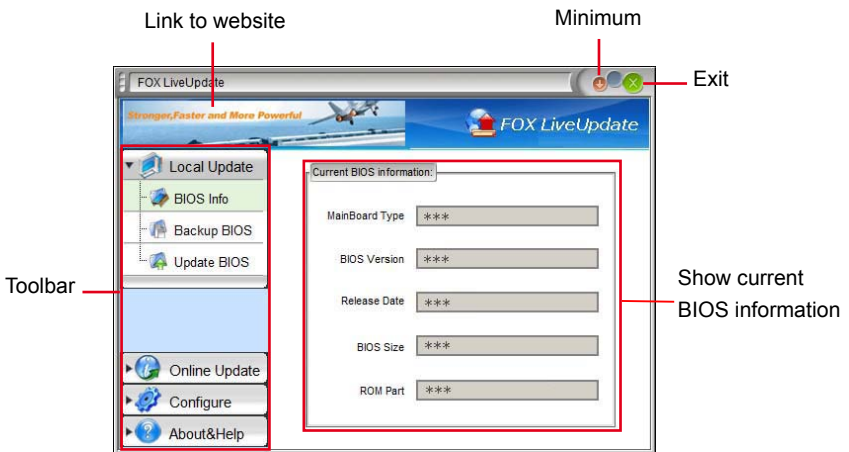

\*\*\* : please refer to the physical motherboard for detail.

## 1-2 Local Update - Backup

This page can backup your system BIOS. You can click "Backup", and key in a file name, then click "Save" to finish the backup operation. The extension of this backup file is ".BIN" for Award BIOS and ".ROM" for AMI BIOS. Default directory is "C:\Desktop\My Documents" in Windows XP and "Documents" in Vista. Make sure you can remember the file name together with the directory which it is stored, prevented that you may need them to recover your BIOS later.

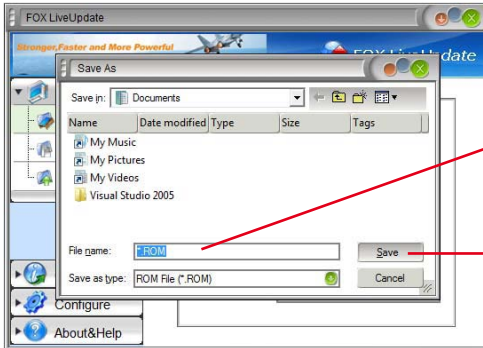

Key in a BIOS name

Click here

## 1-3 Local Update - Update

This page helps you to update your BIOS from a local file. After click "Update", An alert message will be displayed to ensure if you really want to continue, click "Yes" to confirm. A setup wizard will guide you to load a local BIOS file to finish the operation. You must remember from which directory to load your new BIOS file (with an extension of ".BIN" for Award BIOS, ".ROM" for AMI BIOS) before the setup wizard starts.

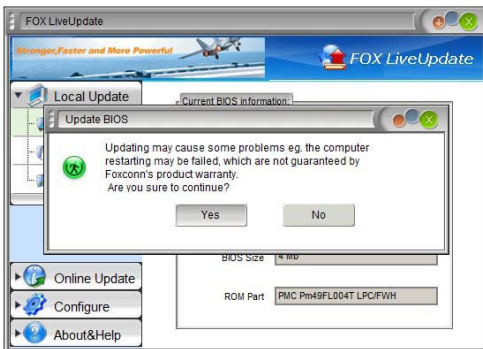

FOX LiveUpdate can automatically backup old BIOS before update. This feature can be enabled in the "Configure-System" setup. Please refer to "Configure-System" section for more detail. The default backup directory is C:\LiveUpdate\_Temp, but the backup file name will be automatically generated. It is hard to find it out from a backup directory, and we recommend you using Explorer to check date/time message of this backup file to find it out and write its name down to remember it.

## 2. Online Update

### 2-1 Online Update - Update BIOS

This page lets you update your system BIOS from Internet. Click “start”, it will search the new BIOS from Internet. Then follow the wizard to finish the update operation.

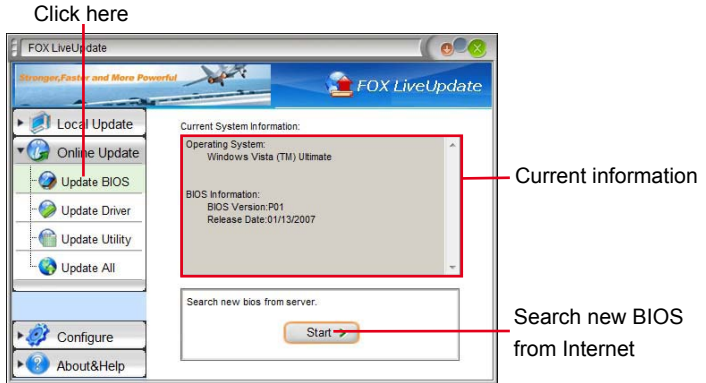

### Select BIOS to update

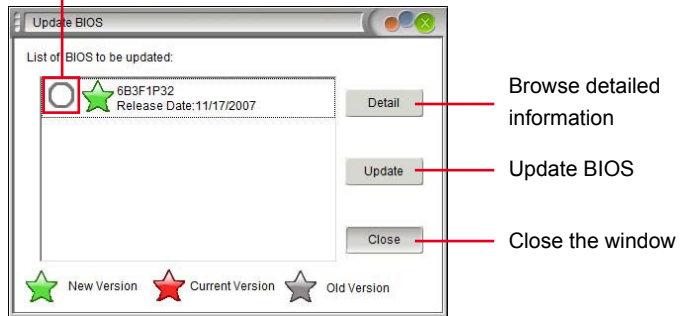

### 2-2 Online Update - Update Driver

This page lets you update your system drivers from Internet. Click “start”, it will search the new drivers from Internet. Then follow the wizard to finish the update operation.

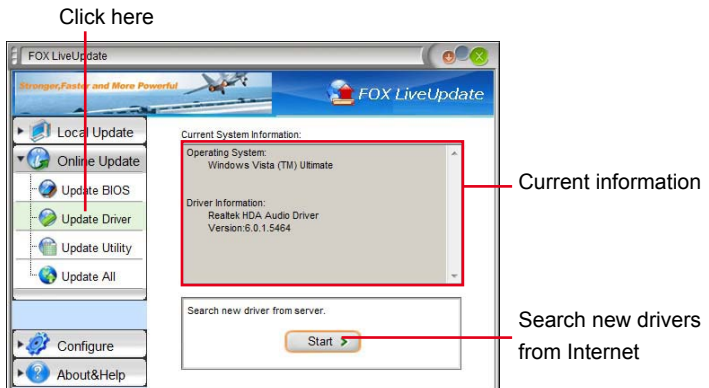

### Select the driver to update

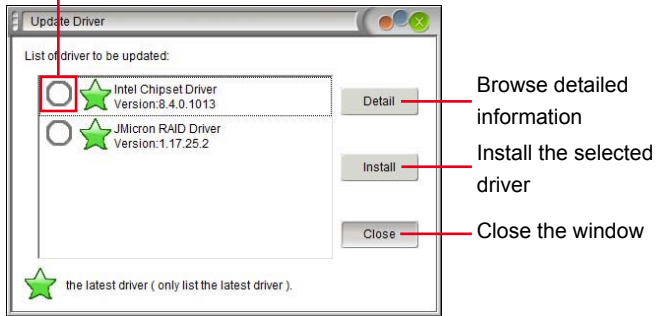

## 2-3 Online Update - Update Utility

This page lets you update utilities from Internet. Click "start", it will search the new utilities from Internet. Then follow the wizard to finish the update operation.

Click here

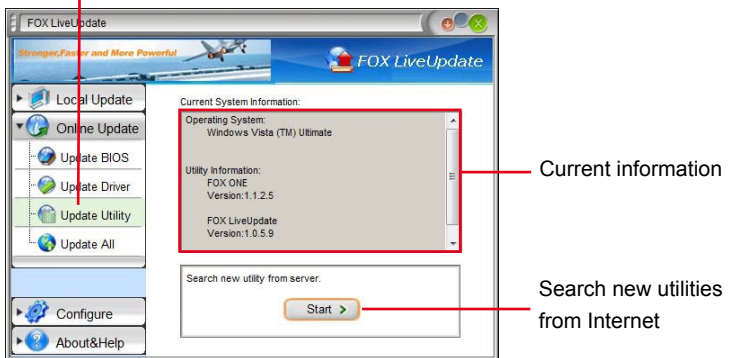

### Select the utility to update

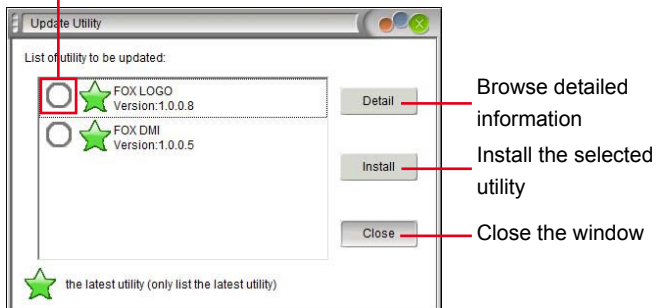

## 2-4 Online Update - Update All

This page lets you update your system drivers from Internet. Click "start", it will search all new BIOS/drivers/utilities from Internet. Then follow the wizard to finish the update operation.

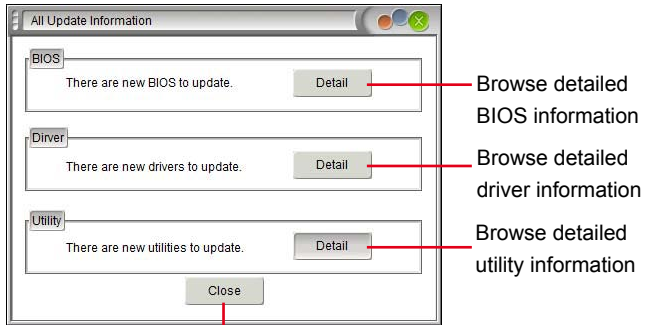
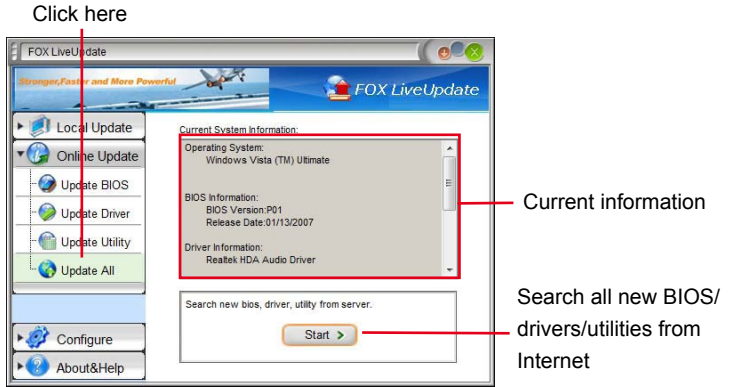

Close the window

### 3. Configure

#### 3-1 Configure - option

This page lets you set auto search options. After you enable the auto search function, FOX LiveUpdate will start its searching from Internet and if any qualified item found, it will pop out a message on the task bar to inform you to do the next step.

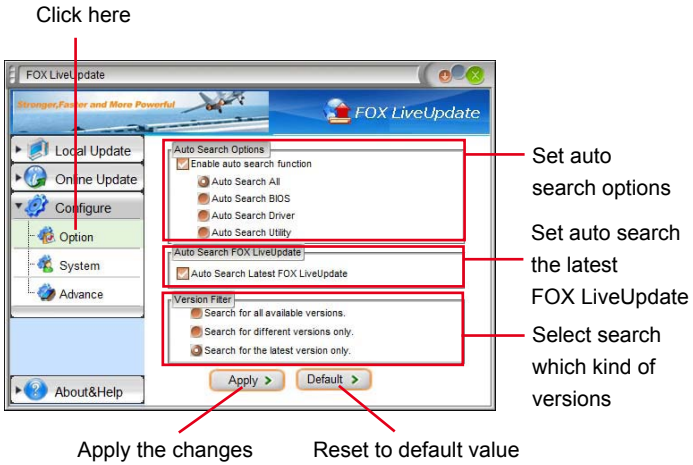

Double click on the icon as show below, you can see the detailed information.

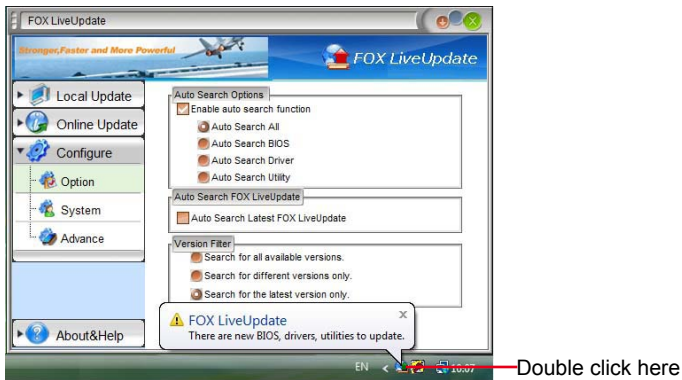



When you enable "Auto Search FOX LiveUpdate", if your FOX LiveUpdate version is older, it will auto search from internet and prompt you to install the new version.

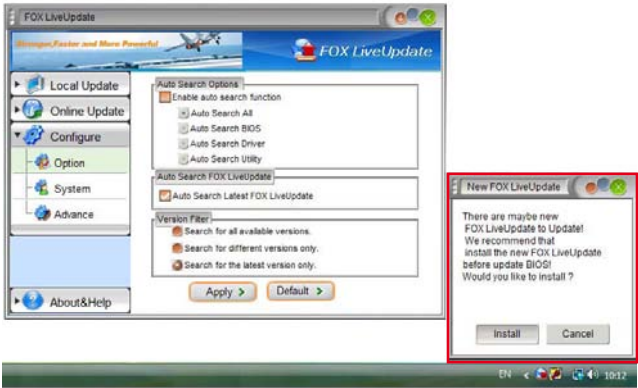

Prompt you to install the new FOX LiveUpdate

### 3-2 Configure - System

This page lets you set the backup BIOS location and change different skin of the FOX LiveUpdate utility.

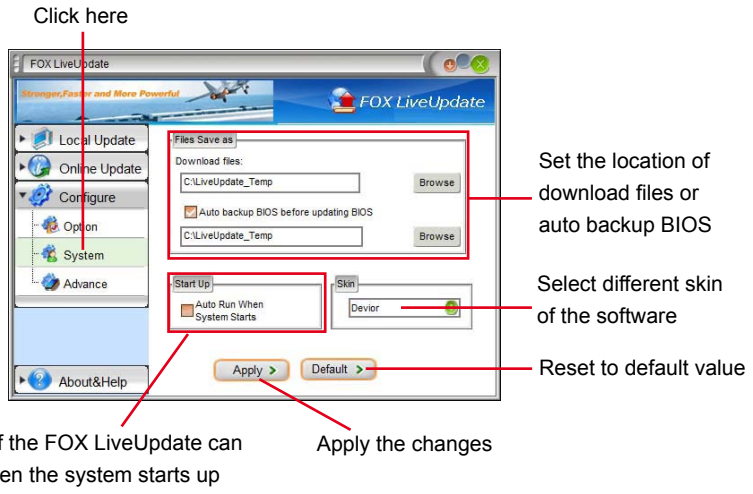

Determine if the FOX LiveUpdate can auto run when the system starts up

Apply the changes

### 3-3 Configure - Advance

This page lets you select to flash BIOS / Boot Block and clear CMOS. If you choose Flash Boot Block, it means BIOS is not protective, and you must make sure the flash process is continuous and without any interruption.

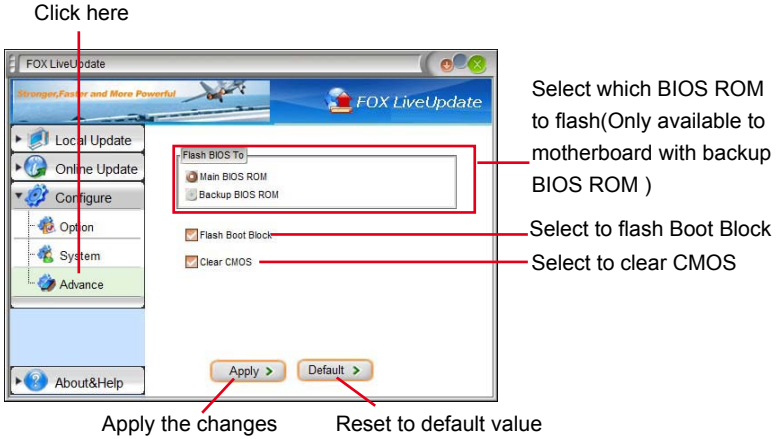

We recommend that you should better keep the default setting unchanged to avoid any damage.

### 4. About & Help

This page shows some information about FOX LiveUpdate.

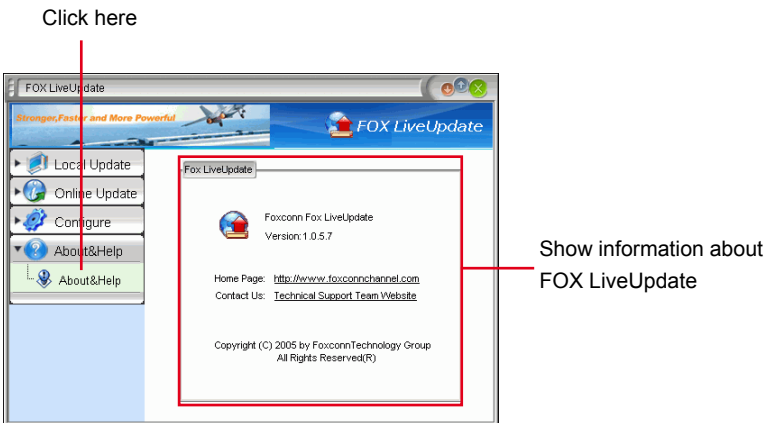

# FOX LOGO

FOX LOGO is a simple and useful utility to backup, change and delete the boot time Logo. The boot Logo is the image that appears on screen during POST (Power-On Self-Test).

You can prepare a JPG image (1024x768) file, then use FOX LOGO to open it and change the boot time Logo. Boot time Logo will be displayed if you enable the BIOS "Quiet Boot" setting in "Advanced BIOS Features" menu.

Supporting Operating Systems :

- Windows 2000
- Windows XP (32-bit and 64-bit)
- Windows 2003 (32-bit and 64-bit)
- Windows Vista (32-bit and 64-bit)

## Using FOX LOGO:

### Main Page



When you change Logo or delete current Logo, the system will flash BIOS file automatically. During this time, please DO NOT shut down the application and the system, or the motherboard will be damaged seriously.

# FOX DMI

FOX DMI is a full Desktop Management Interface viewer, and it provides three DMI data formats : Report, Data Fields and Memory Dump.

With DMI information, system maker can easily analyze and troubleshoot your motherboard if there is any problem occurred.

Supporting Operating Systems :

- Windows 2000
- Windows XP (32-bit and 64-bit)
- Windows 2003 (32-bit and 64-bit)
- Windows Vista (32-bit and 64-bit)

## Using FOX DMI:

Please operate this utility as the comments shows.

Click here to select the type you want to view.

Click here to select the DMI Data format you need

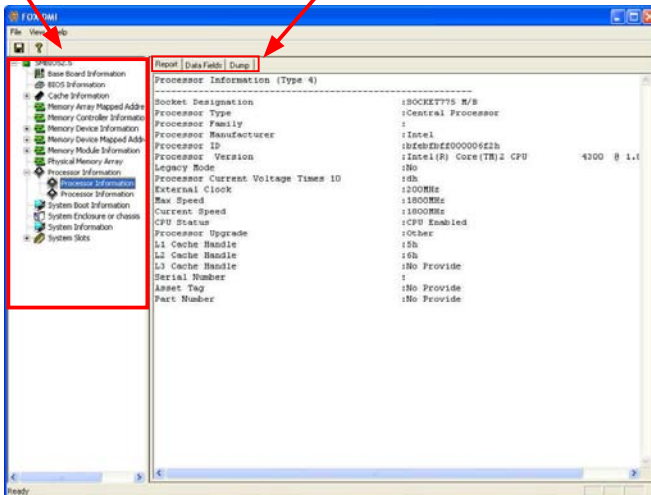



# 5

This chapter will cover two topics :

- Creating a Bootable Array - Installing a new Windows XP (or Vista) in a brand new RAID system.
- Creating a Non-Bootable Array - Existing Windows XP (or Vista) system with new RAID built as data storage.

It includes the following information :

- RAID Configuration Introduction
- FastBuild Driver
- Create a RAID Driver Diskette
- RAID Enable in BIOS
- Select a RAID Array for use
- Install a New Windows XP
- Setting up a Non-Bootable RAID Array

The RAID BIOS Setup pictures shown in this chapter are for reference only, please refer to the practical screen.

## **Creating a Bootable Array** - Installing a new Windows XP (or Vista) in a brand new RAID system.

1. Follow 5-1 to create a RAID driver diskette.
2. Follow 5-2 to set RAID enabled in BIOS.
3. Follow 5-3 to select a RAID array for use.
4. Follow 5-4 to Install a new Windows Operating System.

What kinds of hardware and software you need here :

1. A floppy drive.
2. A CD/DVD-ROM drive.
3. Several SATA hard disks.
4. A RAID driver diskette. (Could be bundled in motherboard package.)
5. A motherboard driver CD. (To create RAID driver diskette if it is not bundled.)
6. Windows XP or Vista Install CD.

## **Creating a Non-Bootable Array** - Existing Windows XP (or Vista) system with new RAID built as data storage.

Follow 5-5 to go through the processes to build a new RAID array in your existing Windows XP system, it includes :

1. Set RAID enabled in BIOS.
2. Follow 5-3 to select a RAID array for use.
3. Run setup program to install AMD RAID driver into your current Windows XP system.
4. Use Administrative Tools in Control Panel to format new RAID array.

What kinds of hardware and software you need here :

1. A CD/DVD-ROM drive.
2. Several SATA hard disks.
3. A motherboard driver CD.

## RAID Configuration Introduction

RAID (Redundant Array of Independent Disks) is a method for computer data storage schemes that divide and/or replicate data among multiple hard drives. RAID can be designed to provide increased data reliability (fault tolerance) or increased I/O (input/output) performance, or both. The following RAID configurations are provided for users.

There are three major key concepts in RAID:

1. Mirroring : The copying of data to more than one disk;
2. Striping : The splitting of data across more than one disk;
3. Error correction : Where redundant data is stored to allow problems to be detected and possibly fixed (known as fault tolerance).

6 Different RAID levels use one or more of these techniques, depending on the system requirements. The main aims of using RAID are to improve reliability, important for protecting information that is critical to a business, for example a database of customer orders; or where speed is important, for example a system that delivers video on demand TV programs to many viewers.

The configuration affects reliability and performance in different ways. The problem with using more disks is that it is more likely that one will go wrong, but by using error checking the total system can be made more reliable by being able to survive and repair the failure. Basic mirroring can speed up reading data as a system can read different data from both the disks, but it may be slow for writing if it insists that both disks must confirm that the data is correctly written. Striping is often used for performance, where it allows sequences of data to be read off multiple disks at the same time. Error checking typically will slow the system down as data needs to be read from several places and compared. The design of RAID systems is therefore a compromise and understanding the requirements of a system is important. Modern disk arrays typically provide the facility to select the appropriate RAID configuration.

RAID is often used in high availability systems, where it is important that the system keeps running as much of the time as possible.

### RAID 0 (Striped)

RAID 0 reads and writes sectors of data interleaved among multiple drives. If any disk member fails, it affects the entire array. The disk array data capacity is equal to the number of drive members times the capacity of the smallest member. RAID 0 does not support fault tolerance.

### RAID 1 (Mirror)

RAID 1 writes duplicate data onto a pair of drives and reads both sets of data in parallel. If one of the mirrored drives suffers a mechanical failure or does not respond, the remaining drive will continue to function. Due to redundancy, the drive capacity of the array is the capacity of the smallest drive.

### RAID Ready

A "RAID Ready" system is a specific system configuration that, with the addition of a second Serial ATA hard drive, can be seamlessly migrated to a configuration that provides either improved storage performance or data protection from a single hard drive failure.

### RAID 10 (Striped Mirror)

RAID 10 is a combination of striping and mirroring. This configuration provides optimal speed and reliability, but you need four SATA hard disks.

### Span (JBOD)

JBOD stands for "Just a Bunch of Disks". Each drive is accessed as if it were on a standard SCSI host bus adapter. This is useful when a single drive configuration is needed, but it offers no speed improvement or fault tolerance. A spanned volume is a formatted partition which data is stored on more than one hard disk, yet appears as one volume. Unlike RAID, spanned volumes have no fault-tolerance, so if any disk fails, the data on the whole volume could be lost. Additionally, the system or boot partitions cannot be included in a spanned volume. FAT16/32 and NTFS file systems may be used, and the volume can span up to 32 hard disks.

### Comparison Table :

Solution	Hard Disks No.	Capacity	Performance	Reliability	Application
RAID0	$\geq 2$	All	Highest	Dangerous	Look for speed
RAID1	2	50%	Read faster	Excellent	100% Data backup
RAID10	$\geq 4$ (Even number)	Smallest *2	High	Excellent	Unlimited budget
Span	$\geq 1$	All	none	Dangerous	Big disk space



# FastBuild Driver

The FastBuild driver supports RAID 0 ,RAID 1 and RAID10 functions. It allows you to get high performance with fault tolerance, big capacity, or data safety provided by different RAID functions.

Here, we will use four SATA hard disks as an example to guide you through how to configure your RAID system. Assume four hard disks are connected to the motherboard :

SATA port 1 - HDS728090PLA380, 82.34GB

SATA port 2 - WDC WD1200JD-98HBB0, 120.03GB

SATA port 3 - Hitachi HDT725025VLA3, 250.05GB

SATA port 4 - ST3320620AS, 320.07GB



To achieve the best performance and reliability, we highly recommend you using the hard disks with the same brand, size and model number. Though we are using four different hard disks as an example to describe RAID function in this chapter, it is only helpful in explaining what the final disk volume of the RAID array will be. In the real world, using the same model to build a disk array is strongly recommended.

The relationships between port numbers in the FastBuild BIOS and SATA ports on the motherboard are shown below. They are :

Channel 1 is the SATA port 1 of the motherboard.

Channel 2 is the SATA port 2.

Channel 3 is the SATA port 3.

Channel 4 is the SATA port 4.

Option ROM Utility (c) 2008 Advanced Micro Devices, Inc.

[View Drives Assignment](#)

Channel	ID	Drive Model	Compatibilities	Capacity(GB)	Assignment
1	Mas	HDS728090PLA380	SATA 3G	82.34	
		Extent 1		82.28	Free
2	Mas	WDC WD1200JD-98HBB0	SATA 1.5G	120.03	
		Extent 1		119.96	Free
3	Mas	Hitachi HDT725025VLA3	SATA 3G	250.05	
		Extent 1		249.99	Free
4	Mas	ST3320620AS	SATA 1.5G	320.07	
		Extent 1		320.00	Free

[Keys Available](#)

[F1] Up [F2] Down [ESC] Exit [Ctrl+H] Secure Erase [PgUp/Dn] Page Change

**Two topics will be covered in the following sections :**

- 1). Creating a Bootable Array** - Installing a new Windows XP in a brand new RAID system.
- 2). Creating a Non-Bootable Array** - Existing Windows XP system with new RAID built as data storage.

Install SATA Hard Disks before we continue :

- Shut down your computer.
- Install SATA hard disks into the drive bays, connect all power and SATA cables.



Before installing the SATA hard disks, make sure to turn off the computer and unplug the power cord from the power outlet to prevent damage to the hardware.

## 5-1 Create a RAID Driver Diskette

If you want to install a brand new Windows XP on a RAID system, you need to create a RAID driver floppy diskette which will be used during Windows XP installation later.

1. Find a PC, put a diskette into its floppy drive A.; this diskette will be formatted later. Put the driver CD into DVD-ROM drive.
2. Depending on which platform your system is, normally, it is a 32-bit XP system. Use Windows explorer, and go to **CD:\Driver\AMD\RAID\Floppy\WinXP\**, click on RaidTool icon to start the creation.



3. Click on "GO" to Start.



4. Select the desired destination FDD drive. It can be the default drive A: or any USB FDD. Click "OK" to continue.



5. Insert a diskette, click "OK" to continue.

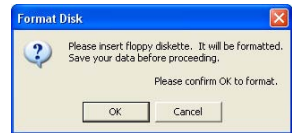

6. You can input a volume label for this diskette, click on "Start" to format.

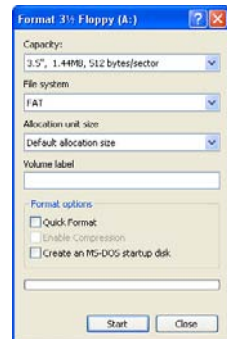

7. Click on "OK" to go through this warning message.

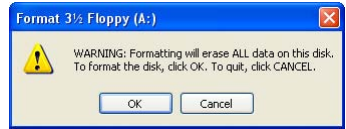

8. Format finished. Click "OK" to continue copying of RAID driver into this diskette.

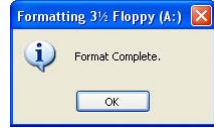

9. Check if the first diskette contains the driver files.

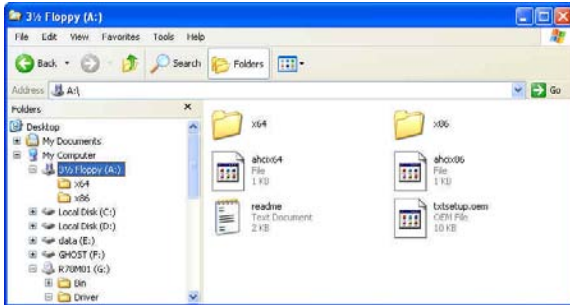

## 5-2 RAID Enable in BIOS

1. Enter the BIOS setup by pressing <DEL> key when boot up.
2. Select the “Integrated Peripherals” from the “Main menu”, then select the “IDE Configuration” menu and press <Enter> to go to the configuration items.
3. Enable RAID function and individual SATA port for hard drive or DVD connection.
4. Press <F10> to save the setting then PC will reboot itself.

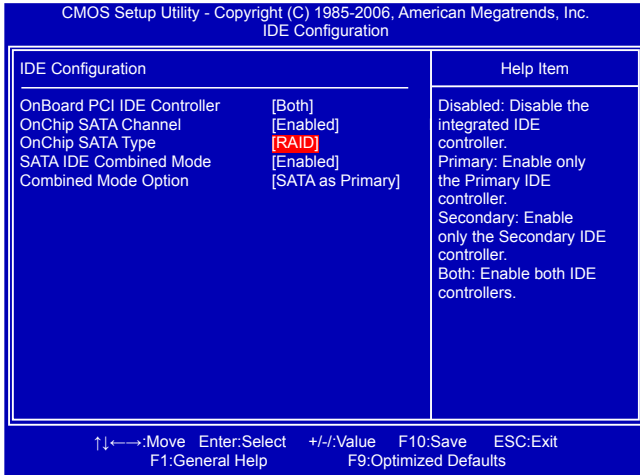

## 5-3 Select a RAID Array for Use

When BIOS is restarted, it will display a message asking you to press [Ctrl-F] key to enter the main menu of FastBuild BIOS. Press [Ctrl-F], the Main Menu appears.

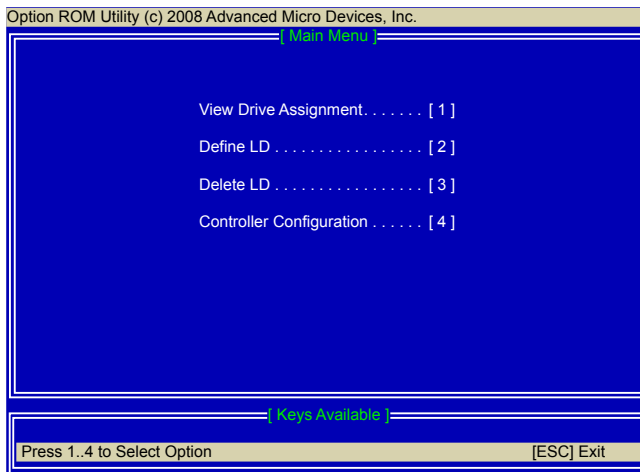

## Create RAID 0 (Striped)

Here, we will show you how to create two RAID 0 Logical Drives (LD) by using two hard disks.

1. Select [2] from the main menu, "Define LD Menu" appears.



2. Press [Enter], the screen appears as below, select RAID 0.
3. Use [↓] key to select the hard disks, press [Space] key to change its assignment status to "Y".
4. Press [Ctrl-Y] to save the setting

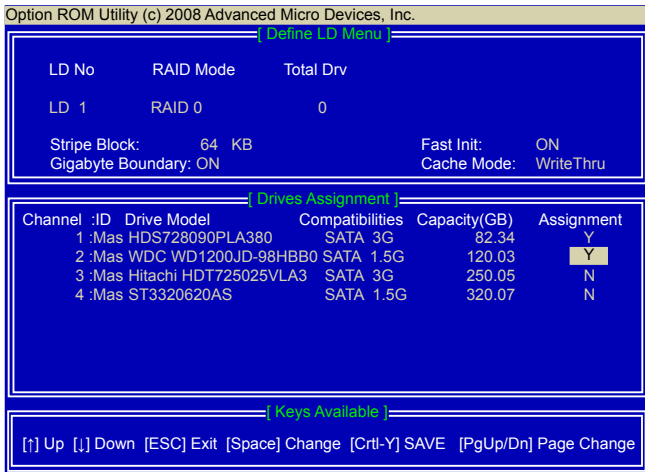

5. A message prompts.

Press [Ctrl-Y] to erase the RAID array.

Fast Initialization Option has been selected  
It will erase the MBR data of the disks,  
<Press Ctrl-Y Key if you are sure to erase it>  
<Press any other key to ignore this option>

6. Another screen prompts.

Press [Ctrl-Y]. Input 80GB to select the first logical drive (LD1) and press [Enter].

Press Ctrl-Y to Modify Array Capacity or press any other key to use maximum capacity...

Option ROM Utility (c) 2008 Advanced Micro Devices, Inc.

[ Define LD Menu ]

LD No	RAID Mode	Total Drv	Capacity(GB)
LD 1	RAID 0	2	164.56

Stripe Block: 64 KB      Fast Init: ON  
Gigabyte Boundary: OFF      Cache Mode: WriteThru

[ Drives Assignment ]

Channel	:ID	Drive Model	Compatibilities	Capacity(GB)	Assignment
1	:Mas	HDS728090PLA380	SATA 3G	82.34	Y
2	:Mas				Y
3	:Mas				N
4	:Mas				N

[ Keys Available ]

[0-9] Input Capacity    [Enter] Save    [Backspace] Delete    [ESC] exit

7. The selection of LD1 array is completed.

As we want to introduce how to create two logical drives by using the same two hard drives here, so we will press [,] to select LD2.

Option ROM Utility (c) 2008 Advanced Micro Devices, Inc.

[ Define LD Menu ]

LD No	RAID Mode	Total Drv	Capacity(GB)	Status
LD 1	RAID 0	2	79.99	Functional
LD 2	----	----	-----	----
LD 3	----	----	-----	----
LD 4	----	----	-----	----
LD 5	----	----	-----	----
LD 6	----	----	-----	----
LD 7	----	----	-----	----
LD 8	----	----	-----	----
LD 9	----	----	-----	----
LD10	----	----	-----	----

[ Keys Available ]

[↑] Up    [,] Down    [ESC] Exit    [Enter] Select

8. When LD2 is selected, press [Enter] to continue.

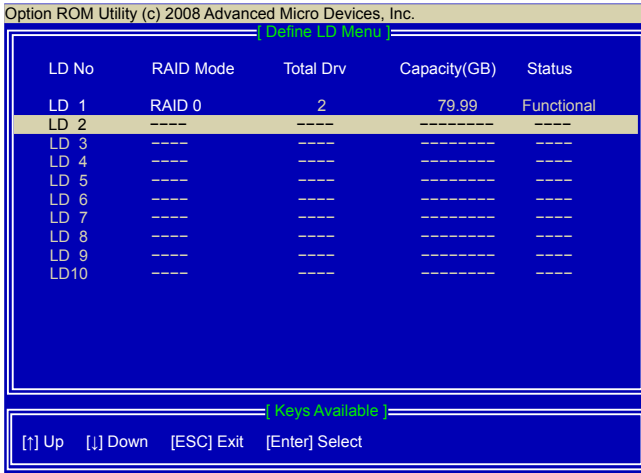

9. You can see in the previous example, about 40GB of Channel 1 and 2 hard disks were allocated. Select the remaining spaces from them for RAID0 again. Press [Ctrl-Y] to save the setting.

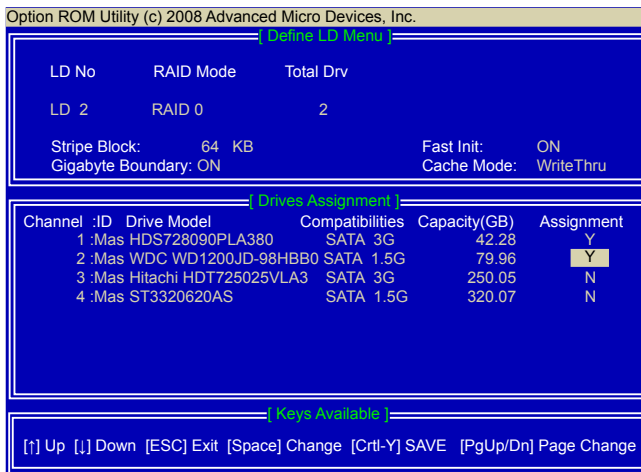



10. A message prompts.

Press [Ctrl-Y] to erase the RAID array.

Option ROM Utility (c) 2008 Advanced Micro Devices, Inc.

[ Define LD Menu ]

LD No	RAID Mode	Total Drv
LD 2	RAID 0	2

Stripe Block: 64 KB      Fast Init: ON  
Gigabyte Boundary: ON      Cache Mode: WriteThru

Channel	:ID	Fast Initialization Option has been selected It will erase the MBR data of the disks. <Press Ctrl-Y Key if you are sure to erase it> <Press any other key to ignore this option>	Assignment
1	:Mas		Y
2	:Mas		Y
3	:Mas		N
4	:Mas		N

[ Keys Available ]

[F1] Up [↓] Down [ESC] Exit [Space] Change [Ctrl-Y] SAVE [PgUp/Dn] Page Change

11. The remaining disk spaces are assigned to LD2. The size is about  $42\text{GB} \times 2 = 84\text{GB}$ .

Option ROM Utility (c) 2008 Advanced Micro Devices, Inc.

[ Define LD Menu ]

LD No	RAID Mode	Total Drv	Capacity(GB)	Status
LD 1	RAID 0	2	79.99	Functional
LD 2	RAID 0	2	83.99	Functional
LD 3	----	----	-----	----
LD 4	----	----	-----	----
LD 5	----	----	-----	----
LD 6	----	----	-----	----
LD 7	----	----	-----	----
LD 8	----	----	-----	----
LD 9	----	----	-----	----
LD10	----	----	-----	----

[ Keys Available ]

[F1] Up [↓] Down [ESC] Exit [Enter] Select

## Create RAID 1 (Mirrored)

Here, we will show you how to create one Mirrored Logical Drives (LD) by using two hard disks.

1. Select [2] from the main menu, "Define LD Menu" appears.

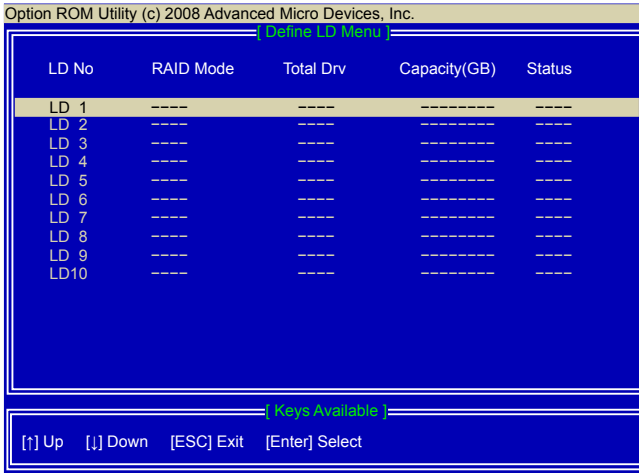

2. Press [Enter], the screen appears as below, select RAID 1.
3. Use [↓] key to select the hard disks, press [Space] key to change its assignment status to "Y".
4. Press [Ctrl-Y] to save the setting.

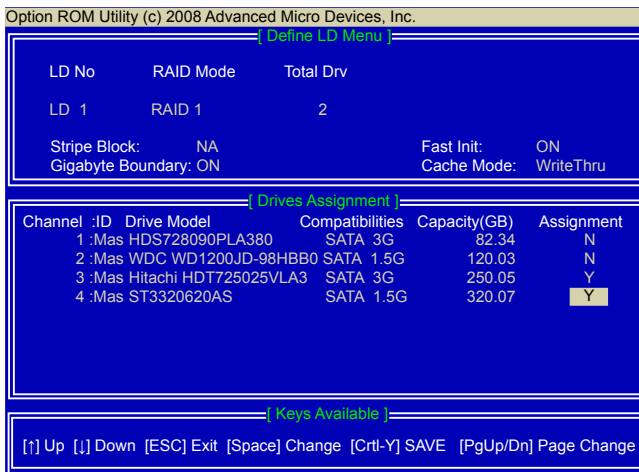

5. A message prompts.

Press [Ctrl-Y] to erase the RAID array.

Fast Initialization Option has been selected  
It will erase the MBR data of the disks,  
<Press Ctrl-Y Key if you are sure to erase it>  
<Press any other key to ignore this option>

6. Another screen prompts.

Press any key to use the maximum capacity.

Option ROM Utility (c) 2008 Advanced Micro Devices, Inc.

[ Define LD Menu ]

LD No	RAID Mode	Total Drv	Capacity(GB)
LD 1	RAID 1	2	249.99

Stripe Block: NA      Fast Init: ON  
Gigabyte Boundary: OFF      Cache Mode: WriteThru

[ Drives Assignment ]

Channel	:ID	Drive Model	Compatibilities	Capacity(GB)	Assignment
1	:	Mas HDS728090PLA380	SATA 3G	82.34	N
2	:	Mas WDC WD1200JD-98HBB0	SATA 1.5G	120.03	N
3	:	Mas Hitachi HD T725025VLA3	SATA 3G	250.05	Y
4	:	Mas ST3320620AS	SATA 1.5G	320.07	Y

Fast Initial      Press Ctrl-Y to Modify Array Capacity or press any other key to use maximum capacity...

7. The selection of LD1 array is completed.

The final capacity of 249.99GB (250GB) is the smaller size of the two hard drives.

Option ROM Utility (c) 2008 Advanced Micro Devices, Inc.

[ Define LD Menu ]

LD No	RAID Mode	Total Drv	Capacity(GB)	Status
LD 1	RAID 1	2	249.99	Functional
LD 2	----	----	-----	----
LD 3	----	----	-----	----
LD 4	----	----	-----	----
LD 5	----	----	-----	----
LD 6	----	----	-----	----
LD 7	----	----	-----	----
LD 8	----	----	-----	----
LD 9	----	----	-----	----
LD10	----	----	-----	----

[ Keys Available ]

[F1] Up    [↓] Down    [ESC] Exit    [Enter] Select

## Create RAID 10 (Striped Mirror)

Here, we will show you how to create one Striped Mirror Logical Drives (LD) by using four hard disks.

1. Select [2] from the main menu, "Define LD Menu" appears.

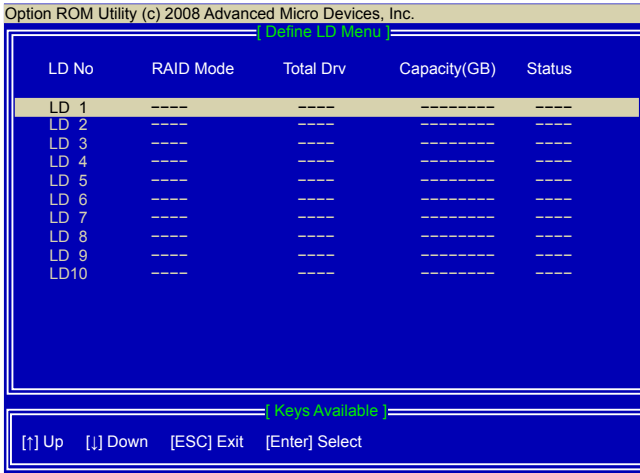

2. Press [Enter], the screen appears as below, select RAID 10.
3. Use [Down] key to select the hard disks, press [Space] key to change its assignment status to "Y".
4. Press [Ctrl-Y] to save the setting.

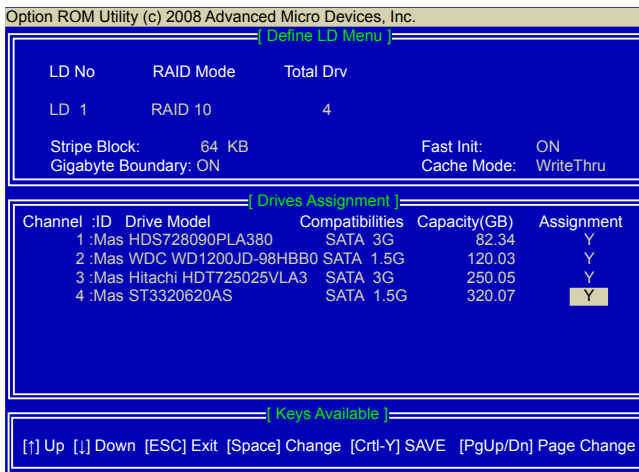

5. A message prompts.

Press [Ctrl-Y] to erase the RAID array.

Fast Initialization Option has been selected  
 It will erase the MBR data of the disks,  
 <Press Ctrl-Y Key if you are sure to erase it>  
 <Pres any other key to ignore this option>

6. Another screen prompts.

Press any key to use the maximum capacity.

Option ROM Utility (c) 2008 Advanced Micro Devices, Inc.

Define LD Menu

LD No	RAID Mode	Total Drv
LD 1	RAID 10	4

Stripe Block: 64 KB      Fast Init: ON  
 Gigabyte Boundary: OFF      Cache Mode: WriteThru

Drives Assignment

Channel	:ID	Drive Model	Compatibilities	Capacity(GB)	Assignment
1	Mas	HDS728090PLA380	SATA 3G	82.34	Y
2	Mas	WDC WD1200JD-98HBB0	SATA 1.5G	120.03	Y
3	Mas	Hitachi HDT725025VLA3	SATA 3G	250.05	Y
4	Mas	ST3320620AS	SATA 1.5G	320.07	Y

Fast Initial      Press Ctrl-Y to Modify Array Capacity or press any other key to use maximum capacity...

7. The selection of LD1 array is completed.

The final capacity of 164.56GB (82.28GB\*2) is twice capacities of the smallest size of the four hard drives.

Option ROM Utility (c) 2008 Advanced Micro Devices, Inc.

Define LD Menu

LD No	RAID Mode	Total Drv	Capacity(GB)	Status
LD 1	RAID 10	4	164.56	Functional
LD 2	----	----	-----	----
LD 3	----	----	-----	----
LD 4	----	----	-----	----
LD 5	----	----	-----	----
LD 6	----	----	-----	----
LD 7	----	----	-----	----
LD 8	----	----	-----	----
LD 9	----	----	-----	----
LD10	----	----	-----	----

Keys Available

[F1] Up    [F2] Down    [ESC] Exit    [Enter] Select

## Create RAID Ready

A "RAID Ready" system is a specific system configuration that, with the addition of a second Serial ATA hard drive, can be seamlessly migrated to a configuration that provides either improved storage performance or data protection from a single hard drive failure.

1. Select [2] from the main menu, "Define LD Menu" appears.

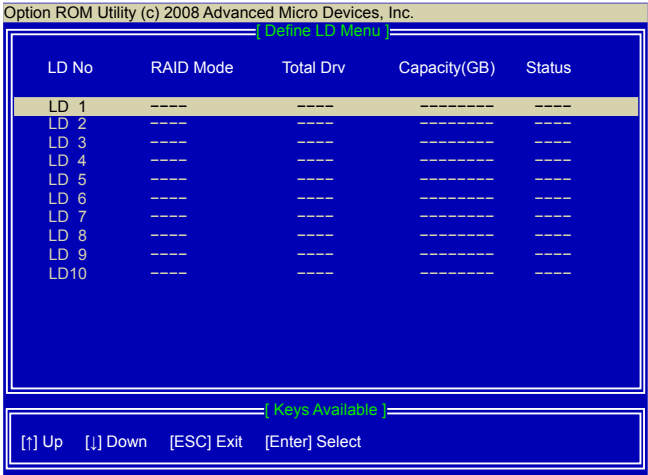

2. Press [Enter], the screen appears as below, select RAID READY.
3. Use [↓] key to select the hard disk, press [Space] key to change its assignment status to "Y".
4. Press [Ctrl-Y] to save the setting.

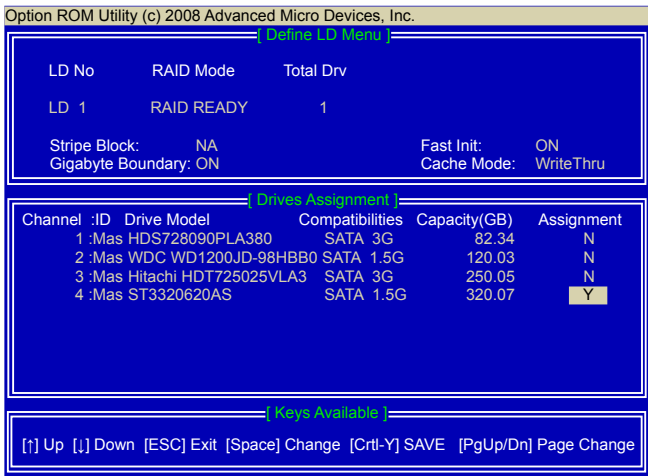

5. A message prompts.

Press [Ctrl-Y] to erase the RAID array.

Option ROM Utility (c) 2008 Advanced Micro Devices, Inc.

[ Define LD Menu ]

LD No	RAID Mode	Total Drv
LD 1	RAID READY	1

Stripe Block: NA                      Fast Init: ON  
Gigabyte Boundary: ON              Cache Mode: WriteThru

Channel	ID	Assignment
1	:Mas	N
2	:Mas	N
3	:Mas	N
4	:Mas	Y

Fast Initialization Option has been selected  
It will erase the MBR data of the disks,  
<Press Ctrl-Y Key if you are sure to erase it>  
<Press any other key to ignore this option>

[ Keys Available ]

[↑] Up [↓] Down [ESC] Exit [Space] Change [Ctrl-Y] SAVE [PgUp/Dn] Page Change

6. The configuration of LD1 array is completed.

Option ROM Utility (c) 2008 Advanced Micro Devices, Inc.

[ Define LD Menu ]

LD No	RAID Mode	Total Drv	Capacity(GB)	Status
LD 1	RAID READY	1	320.00	Functional
LD 2	----	----	-----	----
LD 3	----	----	-----	----
LD 4	----	----	-----	----
LD 5	----	----	-----	----
LD 6	----	----	-----	----
LD 7	----	----	-----	----
LD 8	----	----	-----	----
LD 9	----	----	-----	----
LD10	----	----	-----	----

[ Keys Available ]

[↑] Up [↓] Down [ESC] Exit [Enter] Select

## Create JBOD

Here, we will show you how to create a JBOD Logical Drives (LD) by using four hard disks.

1. Select [2] from the main menu, "Define LD Menu" appears.

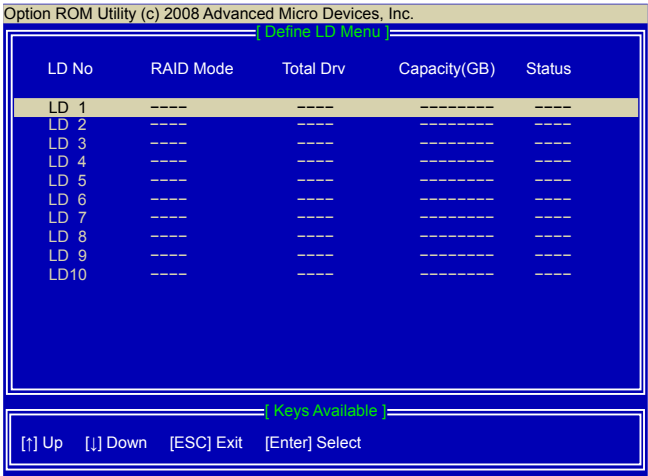

2. Press [Enter], the screen appears as below, select JBOD.
3. Use [↓] key to select the hard disks, press [Space] key to change its assignment status to "Y".
4. Press [Ctrl-Y] to save the setting.

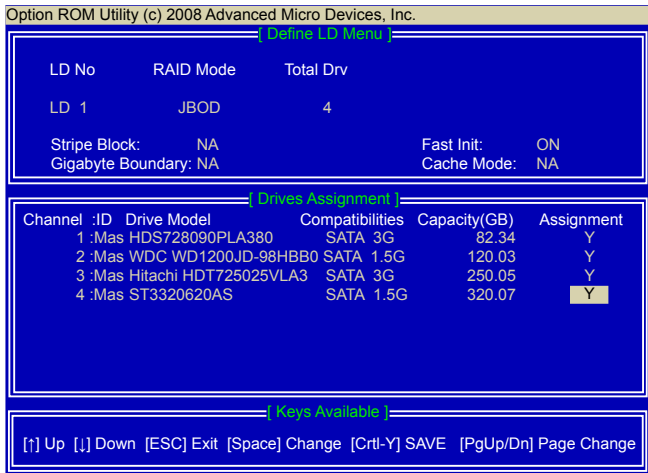



5. A message prompts.

Press [Ctrl-Y] to erase the RAID array.

Option ROM Utility (c) 2008 Advanced Micro Devices, Inc.

[ Define LD Menu ]

LD No	RAID Mode	Total Drv
LD 1	JBOD	4

Stripe Block: 64 KB      Fast Init: ON  
Gigabyte Boundary: ON      Cache Mode: WriteThru

Channel :ID	Fast Initialization Option has been selected It will erase the MBR data of the disks, <Press Ctrl-Y Key if you are sure to erase it> <Press any other key to ignore this option>	Assignment
1 :Mas		Y
2 :Mas		Y
3 :Mas		Y
4 :Mas		Y

[ Keys Available ]

[F1] Up [.] Down [ESC] Exit [Space] Change [Ctrl-Y] SAVE [PgUp/Dn] Page Change

6. The configuration of LD1 array is completed.

Total size is  $82.28+119.96+250.00+320.00 = 772.24\text{GB}$

Option ROM Utility (c) 2008 Advanced Micro Devices, Inc.

[ Define LD Menu ]

LD No	RAID Mode	Total Drv	Capacity(GB)	Status
LD 1	JBOD	4	772.24	Functional
LD 2	----	----	-----	----
LD 3	----	----	-----	----
LD 4	----	----	-----	----
LD 5	----	----	-----	----
LD 6	----	----	-----	----
LD 7	----	----	-----	----
LD 8	----	----	-----	----
LD 9	----	----	-----	----
LD10	----	----	-----	----

[ Keys Available ]

[F1] Up [.] Down [ESC] Exit [Enter] Select

## 5-4 Install a New Windows XP

Assume a Mirrored array (249.99GB) was created as introduced in section 5-3, after the system restarts :

1. Press <DEL> to enter BIOS Setup during POST.
2. Insert the Windows installation CD into the optical drive.
3. Set the "1st Boot Device" to "CD/DVD-ROM", save changes and exit BIOS.

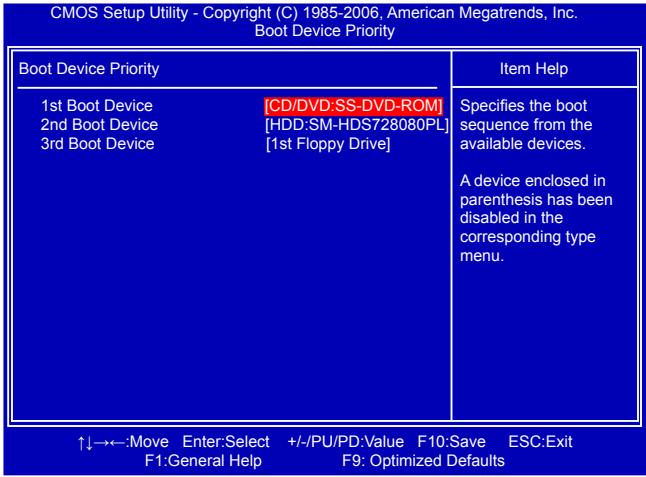

4. The computer will reboot, and it will start installing Windows Operating System. Watch the screen carefully, when the following picture appears, press <F6> key immediately. If you forget to do this, PC will go to an fatal blue screen, and you may need to reboot the system again. PC may not respond to your <F6> input immediately, and it keeps loading files until the next screen displays.



5. After some files are copied to your system, the following picture appears, press <S> to continue the specific driver installation.

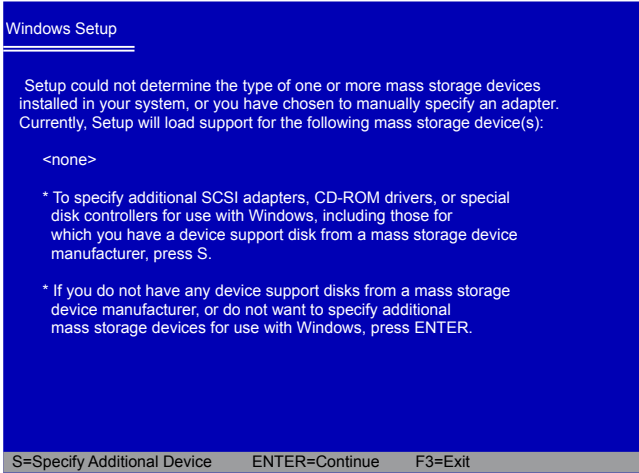

6. It will ask you to insert the RAID driver diskette into you floppy drive. Press <Enter> after it is done.

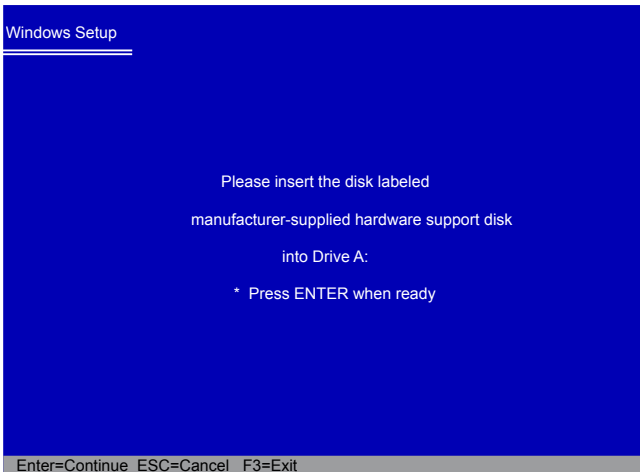

7. There are two drivers, for your 32-bit XP system, press [Enter] to select the first driver - "AMD AHCI Compatible RAID Controller-x86 platform".

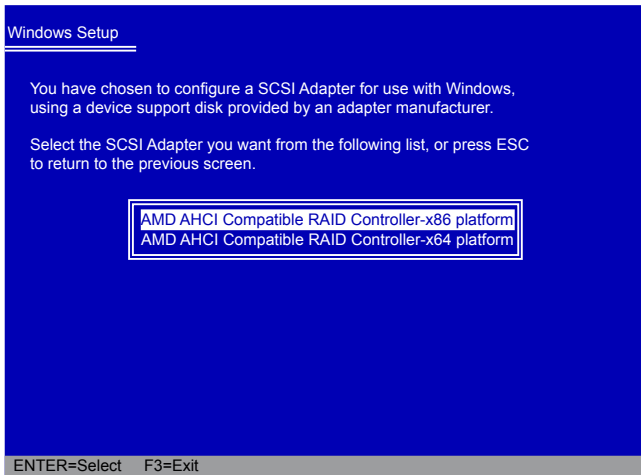

8. A confirmation message appears to double check if the driver is really what we wanted, press <Enter> to continue.

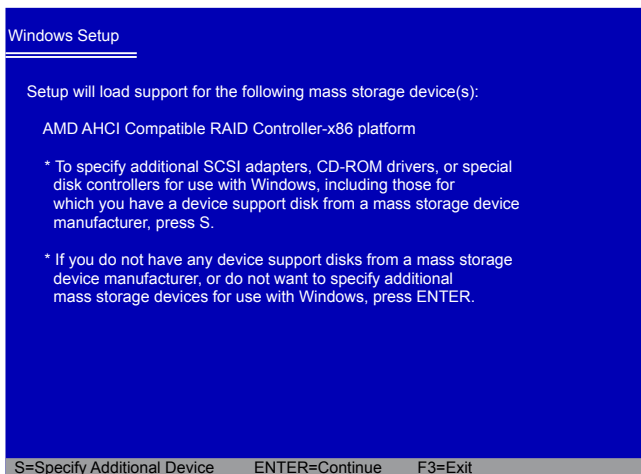

9. Windows will display the partition of your system. As we are using a Mirrored RAID array as an example, its size 232.88GB is now displayed as 238410MB. You can press [C] to create partitions as many as you wish, assign them C:, D: or E: logical drive names.
- (Note :  $238410\text{MB}/1024 = 232.82\text{GB}$ )

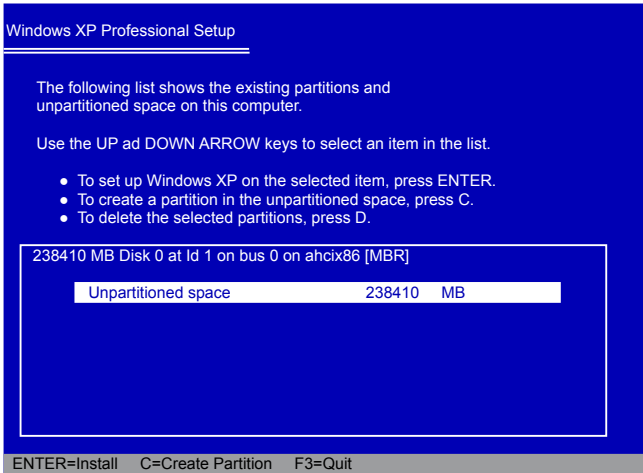

10. In this example, we will create a 30GB partition C: and leave the remaining space as a partition E:. (D: is allocated by a DVD drive)
11. Press <Enter> to install Windows. The Windows XP installation process will ask you to format your hard disk, then copy files...etc. Follow the installation steps until the whole Windows is setup.

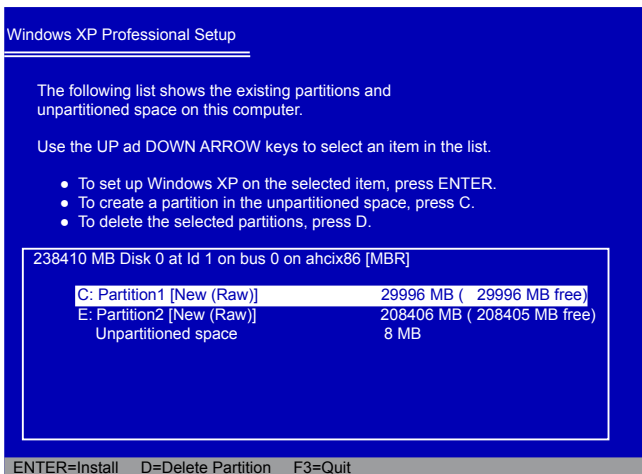

## 5-5 Setting Up a Non-Bootable RAID Array

This section assumes the following setup :

- Boot Disk with Windows XP installed :

One hard disk HDS728090PLAT20 (80GB) is connected to the IDE channel, and set to Master.

- A Mirrored RAID Array Disk :

Two SATA hard disks are configured as a mirrored RAID1 array, they are :  
 Hitachi HDT725025VLA3, (250.05GB) connected to SATA port2 of the motherboard.  
 Seagate ST3320620AS, (320.07GB) connected to SATA port3.

- A SATA DVD Drive :

A DVD drive connected to SATA port1.



To achieve the best performance and reliability, we highly recommend you using the hard disks with the same brand, size and model number. Though we are using different brand of hard disks as an example here, the purpose is only for easy understanding.

1. Reboot your system, and go to "IDE Configuration" menu.

Enable the RAID function. Press [F10] to save the settings and reboot.

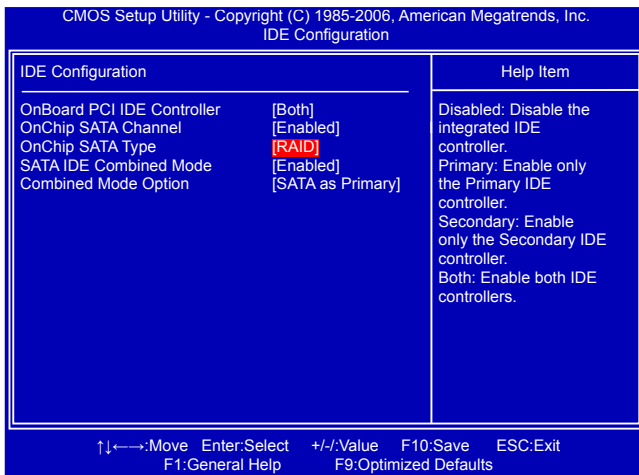

2. Select a RAID array for use (also can refer to section 5-3)

After rebooting your computer, you will see the RAID software prompting you to press [Ctrl-F].

Press [Ctrl-F] to enter the FastBuild BIOS setup and configure the mirrored RAID array as described in the 5-3 section. Finally, you can reach this step as depicted.

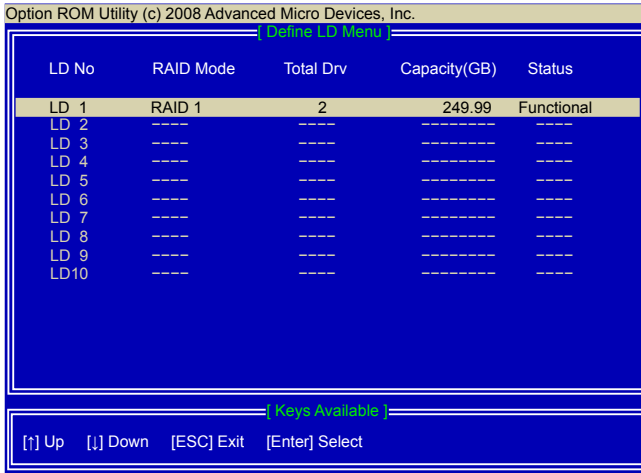

3. Exit FastBuild and restart computer to go to Windows.

4. In Windows, click "Cancel" to skip any "Found New Hardware Wizard".

Use driver CD and click on "AMD RAID Driver" to install the AMD RAID driver. The RAID driver will be installed only when you select "RAID" in "OnChip SATA Type" setting. If you do not select RAID, then RAID driver will not be installed.



5. After the AMD RAID driver is installed, it will ask you to click "Finish" to restart your computer.

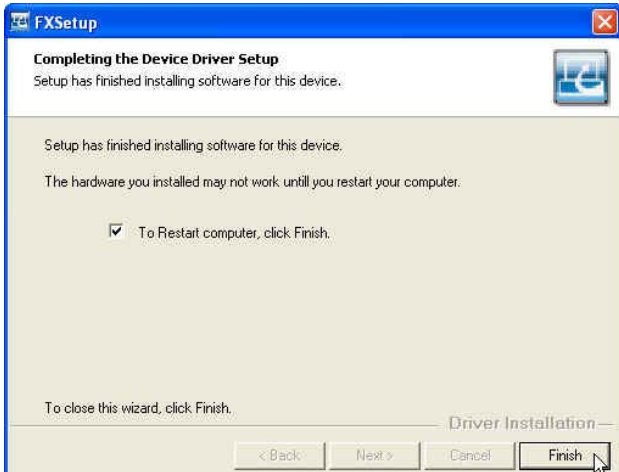

6. When Windows starts, a message is prompting you to reboot again. Click "Yes" to restart your computer.





7. After PC starts, the RAID array is now ready to be initialized under Windows. Launch Computer Management by clicking Start -> (Settings ->) Control Panel then open the Administrative Tools folder and double click on Computer Management. Click Disk Management (under the Storage section). The Initialize and Convert Disk Wizard appears. Click "Next" to continue. The RAID array is named as Disk1 and its status is unknown and not initialized.

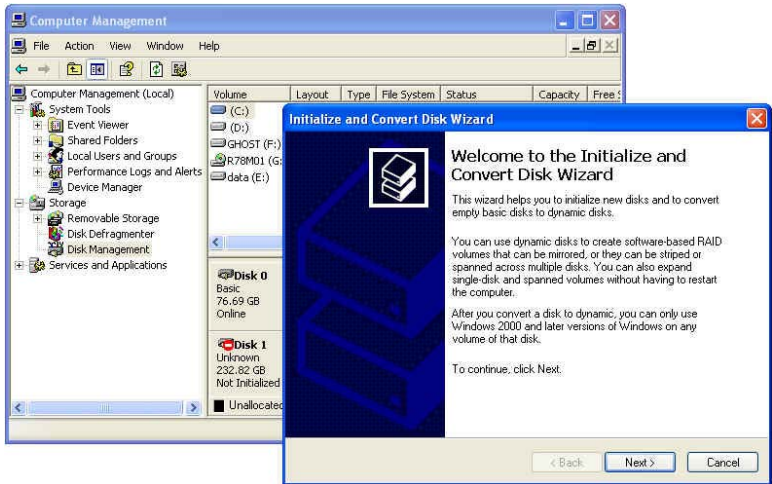

8. A "Select Disks to Initialize" window will appear. The disks listed depend on how many arrays you have configured. Select "Disk1" and click "Next" to continue.
9. When "Select Disks to Convert" window appears, do not select anything and click "Next" to continue.
10. When the "Completing the Initialize and Convert Disk Wizard" window appears, click "Finish" to complete the wizard.



11. The Computer Management window appears. The actual disks listed will depend on your system. In below figure, you can see there is a 232.82 GB unallocated partition. You must format the unallocated disk space before using it. Right click "Unallocated space", select "New Partition..." and follow the Wizard instructions.

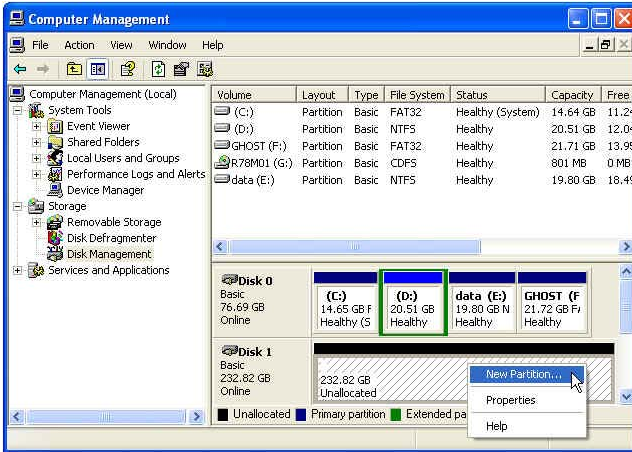

12. When "New Partition Wizard" appears, click "Next" to continue.  
13. When "Primary partition" screen appears, click "Next" to continue.  
14. When "Specify Partition Size" screen appears, click "Next" to continue.  
15. When "Assign Drive Letter or Path" screen appears, click "Next" to continue.  
16. Click "Finish" to end the "New Partition Wizard".

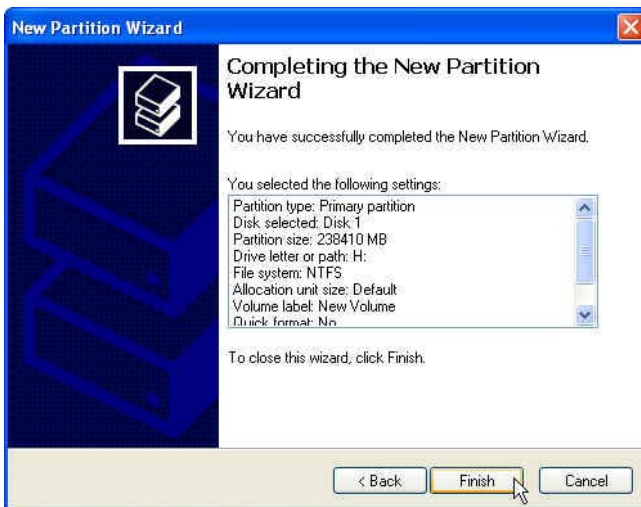

17. The format of disk array (Disk1) is in processing.

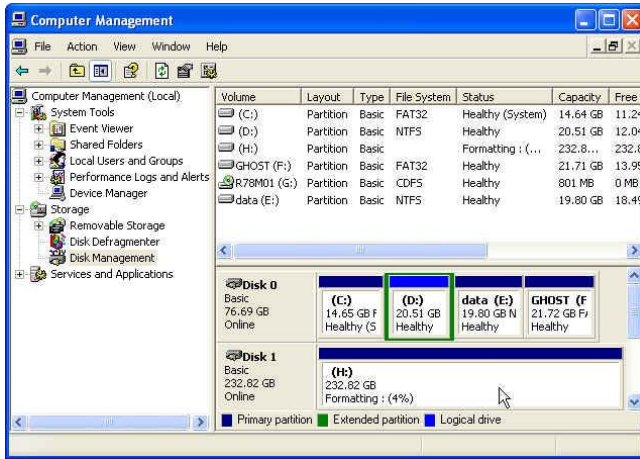

18. Format completed, now you can start using your RAID array.

