

RA-50
RA-50
RA-50

RA-50

A-50
-50
50
J

REALTIME ARRANGER

OWNER'S MANUAL

Apparatus containing Lithium batteries

ADVARSEL!

Lithiumbatteri. Eksplosionsfare.
Udskiftning må kun foretages af en sagkyndig,
og som beskrevet i servicemanual.

VARNING!

Lithiumbatteri. Explosionsrisk.
Får endast bytas av behörig servicetekniker.
Se instruktioner i servicemanualen.

ADVARSEL!

Lithiumbatteri. Fare for eksplosion.
Må bare skiftes av kvalifisert tekniker som
beskrevet i servicemanualen.

VAROITUS!

Lithiumparisto. Räjähdyksvaara.
Pariston saa vaihtaa ainoastaan
alan ammottimies.

Bescheinigung des Herstellers/Importeurs

Hiermit wird bescheinigt, daß der/die/das

ROLAND REALTIME ARRANGER RA-50

(Gerät. Typ. Bezeichnung)

in Übereinstimmung mit den Bestimmungen der

Amtsbl. Vfg 1046/1984

(Amtsblattverfügung)

funk-entstört ist.

Der Deutschen Bundespost wurde das Inverkehrbringen dieses Gerätes angezeigt und die Berechtigung zur Überprüfung der Serie auf Einhaltung der Bestimmungen eingeräumt.

Roland Corporation Osaka/Japan

Name des Herstellers/Importeurs

RADIO AND TELEVISION INTERFERENCE

WARNING — This equipment has been verified to comply with the limits for a Class B computing device, pursuant to Subpart J, of Part 15, of FCC rules. Operation with non-certified or non-verified equipment is likely to result in interference to radio and TV reception.

The equipment described in this manual generates and uses radio frequency energy. If it is not installed and used properly, that is, in strict accordance with our instructions, it may cause interference with radio and television reception. This equipment has been tested and found to comply with the limits for a Class B computing device in accordance with the specifications in Subpart J, of Part 15, of FCC Rules. These rules are designed to provide reasonable protection against such a interference in a residential installation. However, there is no guarantee that the interference will not occur in a particular installation. If this equipment does cause interference to radio or television reception, which can be determined by turning the equipment on and off, the user is encouraged to try to correct the interference by the following measure:

- Disconnect other devices and their input/output cables one at a time. If the interference stops, it is caused by either the other device or its I/O cable. These devices usually require Roland designated shielded I/O cables. For Roland devices, you can obtain the proper shielded cable from your dealer. For non Roland devices, contact the manufacturer or dealer for assistance.
- If your equipment does cause interference to radio or television reception, you can try to correct the interference by using one or more of the following measures.
- Turn the TV or radio antenna until the interference stops.
- Move the equipment to one side or the other of the TV or radio.
- Move the equipment farther away from the TV or radio.
- Plug the equipment into an outlet that is on a different circuit than the TV or radio. (That is, make certain the equipment and the radio or television set are on circuits controlled by different circuit breakers or fuses.)
- Consider installing a rooftop television antenna with coaxial cable lead-in between the antenna and TV. If necessary, you should consult your dealer or an experienced radio/television technician for additional suggestions. You may find helpful the following booklet prepared by the Federal Communications Commission: "How to Identify and Resolve Radio — TV Interference Problems"

This booklet is available from the U.S. Government Printing Office, Washington, D.C., 20402, Stock No. 004-000-00345-4.

CLASS B

NOTICE

This digital apparatus does not exceed the Class B limits for radio noise emissions set out in the Radio Interference Regulations of the Canadian Department of Communications.

CLASSE B

AVIS

Cet appareil numérique ne dépasse pas les limites de la classe B au niveau des émissions de bruits radioélectriques fixés dans le Règlement des signaux parasites par le ministère canadien des Communications.

REALTIME
ARRANGER

RA-50

OWNER'S MANUAL

Thank you for purchasing the Roland Real-time Arranger RA-50. This is a completely new type device that uses high digital technology and Roland's technique for musical instruments. It will give you high quality synthesizer sounds, reverb sounds, automatic accompaniment performance, etc., resulting in a powerful one-man band system. It is designed compactly, but features excellent functions and therefore can be used by inexperienced and professional keyboard players. To make the RA-50 a long and helpful partner, read this owner's manual carefully.

Copyrights © 1989 by ROLAND CORPORATION All rights reserved. No part of this publication may be reproduced in any form without the written permission of ROLAND CORPORATION.

■ HOW TO READ THIS OWNER'S MANUAL

This owner's manual consists of six chapters. The first chapter includes how to set up the RA-50, play the preprogrammed performance data and use the main functions.

The second chapter includes notes on handling the RA-50 and the outline.

The third chapter explains the basic functions of the RA-50.

The fourth chapter explains the more sophisticated functions of the RA-50.

The fifth chapter explains how to use a sequencer and computer with the RA-50.

The final chapter contains references (appendix); what you should do when you make a mistake, panel setting memo, MIDI implementation, index, etc.

First, read the first chapter, then the second. After that, you may go to any following chapter. When you use the RA-50 with a Roland piano (or MIDI keyboard), you do not need to read the fifth chapter.

■ CONTENTS

1 RA-50 ENTERTAINMENT

1 Preparation for playing the RA-50	6
(1) Connection cords and cables	6
(2) Connecting the RA-50 to a Roland Piano	7
(3) Preparation on the Roland Piano (Local OFF)	8
(4) Power-on	8
(5) MIDI Channel Setting	9
2 Playing the preprogrammed performance data (ROM Play)	10
3 Let's enjoy ensemble performance	12
(1) Keyboard Split	12
(2) Listening to the rhythm	14
(3) Accompaniment	15
a. Chord Intelligence	15
b. Melody Intelligence	16

2 BEFORE PLAYING THE RA-50

1 Panel Description	18
(1) Front Panel	18
(2) Rear Panel	18
2 Important Notes	20
3 Connections	21
4 Outline of the RA-50	22
(1) What is the RA-50 ?	22
(2) About "Music Style"	22

3 BASIC PROCEDURE

1 How to enjoy the Split Performance	24
(1) Split function and Tone Assignment	24
(2) Tone List	25
(3) Tone selection for Upper Part	27
(4) Tone selection for Lower Part	28
(5) Notes on tone selecting	28
2 Rhythm and Music Style	29
(1) Music Style List	30
(2) Selecting a Music Style	30
(3) Music Style Card	31
(4) Starting the Music Style	32
a. Immediate start	32
b. Sync start	32
c. Start with Intro	32
d. Sync start with Intro	33
(5) Stopping the Music Style	33
a. Immediate stop	33
b. Stop with Ending	34
(6) Tempo Change	34

3 Arranger (Automatic Accompaniment Playing)	35
(1) Arranger Function (Automatic Accompaniment Function)	35
(2) Chord	35
(3) Style Performance	36
(4) Variation	37
(5) Fill in	38
a. Fill in To Variation	38
b. Fill in To Original	38
(6) Break	39
(7) Chord Hold	39
(8) Chord Intelligence	40
(9) Melody Intelligence	40
■ Étude (Example music sheet)	41

4 INTERMEDIATE PROCEDURE

1 Adjusting the volume balance of each Part	44
(1) Volume balance for the Upper and Lower Parts	44
a. Upper Balance	44
b. Lower Balance	45
(2) Volume balance for the other Parts	45
a. Accompaniment Balance	45
b. Bass Balance	45
c. Drums Balance	45
2 Creating spacious sounds	46
(1) About Reverberation	46
(2) On/Off of the Reverb Effect	46
a. On/Off for all the Parts	46
b. On/Off for individual Part	46
(3) Changing Reverb Types	48
3 User Program	49
(1) Calling a User Program	50
(2) Recording a User Program	52
4 Song Composer (Recording the performance data)	54
(1) Recording a performance 1 - - Recording	54
(2) Playing the performance data 1 - - Playback	57
(3) Playing the performance data 2 - - Repeat	58
(4) Recording a performance 2 - - Monitor Recording	59
5 Using Memory Cards	61
(1) Useful Memory Cards	61
a. Data that can be saved on a memory card	61
b. Memory protect	62
(2) Saving onto a memory card	62
(3) Loading data from a memory card back to the internal memory	63
6 Advanced procedure for playing	65
(1) Tuning the RA-50	65
(2) Setting the Pitch Bend Range	65
(3) Using a Foot Switch	66
(4) Manual Drums	67
(5) LCD Contrast	69
■ Étude (Example music sheet)	70

5 ADVANCED PROCEDURE

1 Setting the MIDI Functions	72
(1) What is MIDI ?	72
(2) Devices that can be connected via MIDI	72
(3) MIDI Sockets on the RA-50	72
a. MIDI (KBD) IN / MIDI (KBD) OUT	72
b. MIDI (SEQ) IN / MIDI (SEQ) OUT	72
(4) Internal Structure of the RA-50	72
(5) Difference between normal transmission and extended transmission	72
(6) Local Control	72
(7) Functions of the Panel Switches for MIDI	73
2 MIDI Channels of Parts / MIDI Filter	73
(1) Setting the MIDI Channels	73
(2) On/Off of MIDI	74
(3) On/Off of Program Change	74
(4) On/Off of Control Change	77
3 Other MIDI Settings	77
(1) Setting the Sync Mode	77
(2) Setting the Bypass Mode	78
(3) Selecting a Program Change Map	78
(4) Editing a Program Change Map	80
4 Using the RA-50 with a MIDI Sequencer	80
(1) MIDI Sequencer	80
(2) Control from a MIDI Sequencer	80
a. When not using the RA-50's Arranger Function	80
b. When using the RA-50's Arranger Function	81
c. When using the RA-50's Arranger Function from the MIDI Sequencer	81
5 Using the RA-50 with a MIDI instrument other than a sequencer	81
(1) Computer (Sequence software)	81
(2) Guitar Synthesizer	82

6 APPENDIX (References)

■ Troubleshooting	84
■ Chord List	88
■ User's Setting Memo	90
■ MIDI Implementation	93
■ Specifications	111
■ Index	112

1

RA-50

ENTERTAINMENT

FIRST OF ALL, EXPLORE THE RA-50.

1

Preparation for playing the RA-50

To play the RA-50, you should connect a Roland piano (or a MIDI piano or keyboard) to the RA-50 using connection cords and MIDI cables. If the keyboard does not feature input sockets or speaker, you will need an amplifier. Make connections as follows.

(1) Connection cords and cables

The following are required for setting up the RA-50 with a Roland piano.

1. MIDI Cable × 2
2. Stereo Audio Cord × 1
3. AC Adaptor × 1

< When using a Roland piano featuring the DC outlet, prepare a DC - DC plug (PCS-25). >

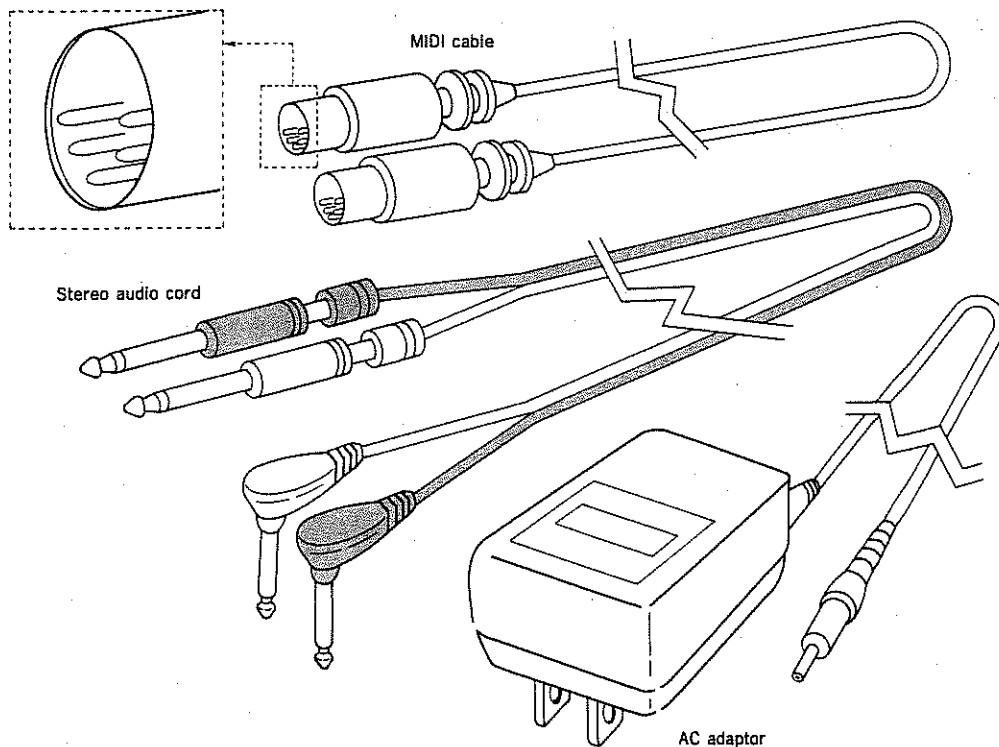

(2) Connecting the RA-50 to a Roland Piano

- ① Connect an AC adaptor (or a DC - DC plug) to the DC IN socket on the rear of the RA-50, set the power switch on the RA-50 to OFF, then insert the plug to the wall sockets (or to the DC outlet on the rear of the Roland piano).

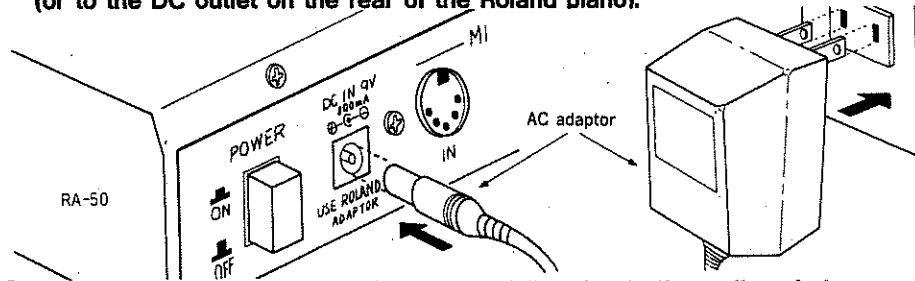

- ② Switch off the Roland piano, then connect the plug to the wall socket.

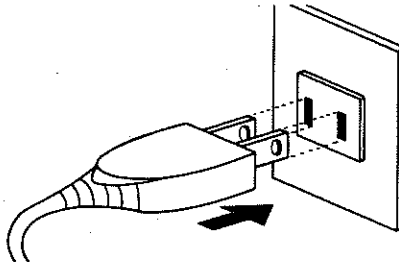

- ③ Connect the MIDI OUT socket on the Roland piano to the MIDI (KBD) IN socket on the RA-50 using a MIDI cable.

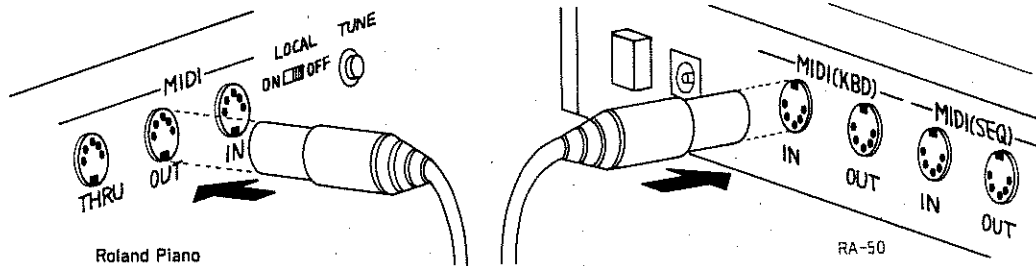

- ④ Connect the MIDI (KBD) OUT socket on the RA-50 to the MIDI IN on the Roland piano using a MIDI cable.

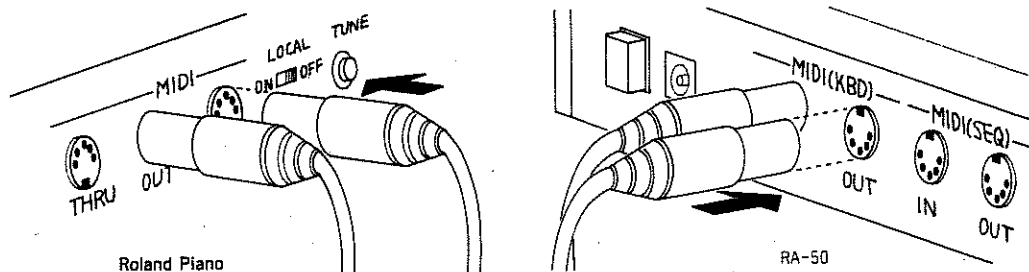

- ⑤ Connect the OUTPUT sockets on the RA-50 to the INPUT sockets on the Roland piano using STEREO audio cord. (Connect L to L and R to R.)

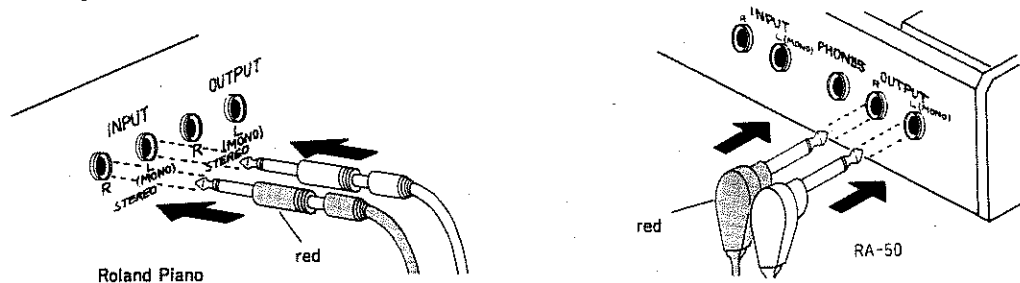

(3) Preparation on the Roland Piano (Local OFF)

- ① Set the Local Switch () on the Roland piano to the OFF (:) position.

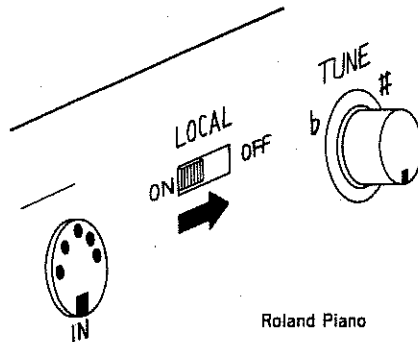

- ② If the piano features the INPUT LEVEL SWITCH, set it to the "H" position.

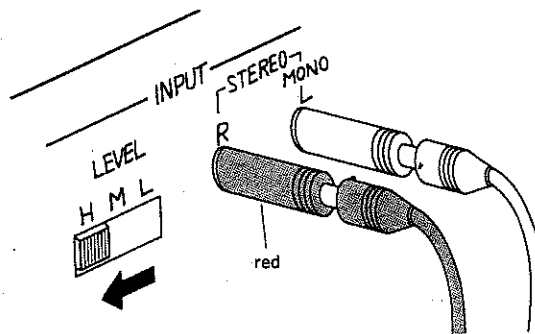

(4) Power-on

- ① Switch the Roland piano on.

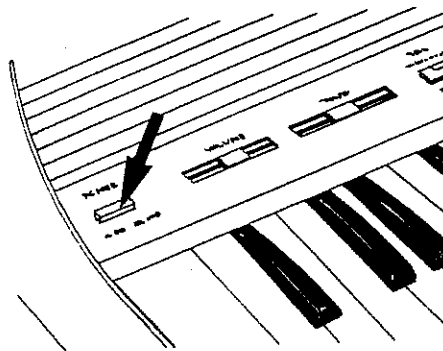

- ② Set the MASTER VOLUME knob on the RA-50 to the MIN position, then switch the RA-50 on.

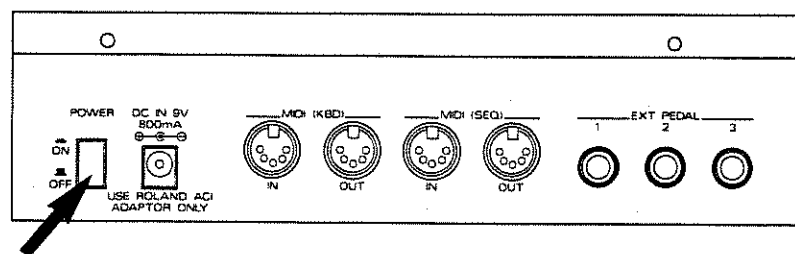

- ③ If you use an amplifier, switch it on.

(5) MIDI Channel Setting

The RA-50's MIDI receive channel is set to 1 from the manufacturer. Normally, a Roland piano is default to MIDI channel 1, so that you do not need to change MIDI channels. However, if the MIDI channel on the Roland piano is set to a different number, change it to 1 as follows.

- Press the far-left key on the keyboard while holding down **KEY TRANSPOSE / MIDI** on the Roland piano.

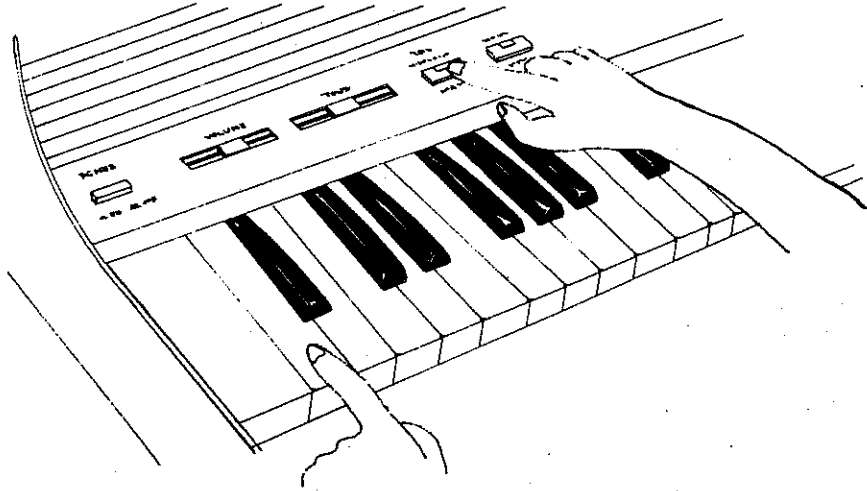

* If you are using a keyboard other than the Roland piano, read the owner's manual of the keyboard to set the MIDI channel (both channels if the keyboard can set the transmit and receive channels separately) to 1. If the MIDI channel of your keyboard is fixed to a number other than 1, read page 73 "1 Setting the MIDI Functions" in the fifth chapter to set the MIDI receive channel of the RA-50 to the same number as the keyboard.

2

Playing the preprogrammed performance data (ROM Play)

Five demonstration songs are preprogrammed in the RA-50's internal memory. Playing these songs is called ROM Play in this manual.

① Press **ROM PLAY**.

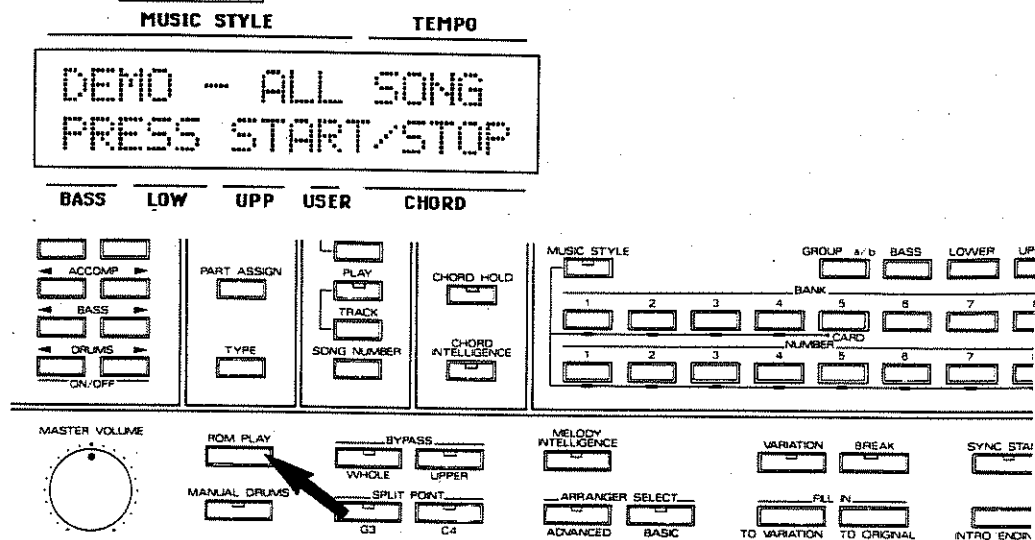

② Press **START/STOP**.

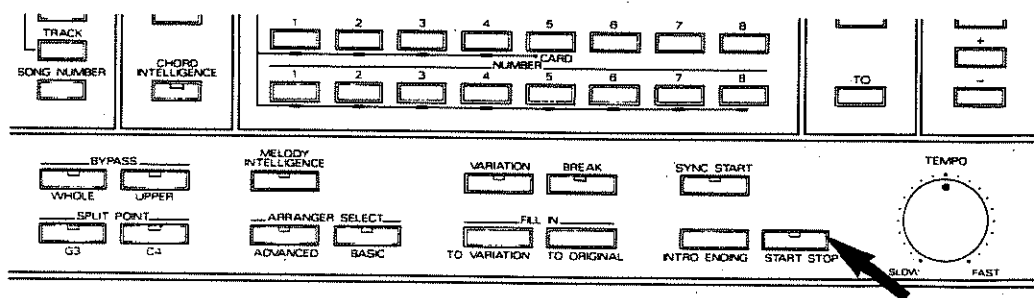

*If you do not press **START/STOP** quickly after pressing **ROM PLAY**, the display will return to the previous indication. To continue to play the demonstration songs, repeat steps ① and ②.

③ Adjust the volume using the MASTER VOLUME knob on the RA-50.

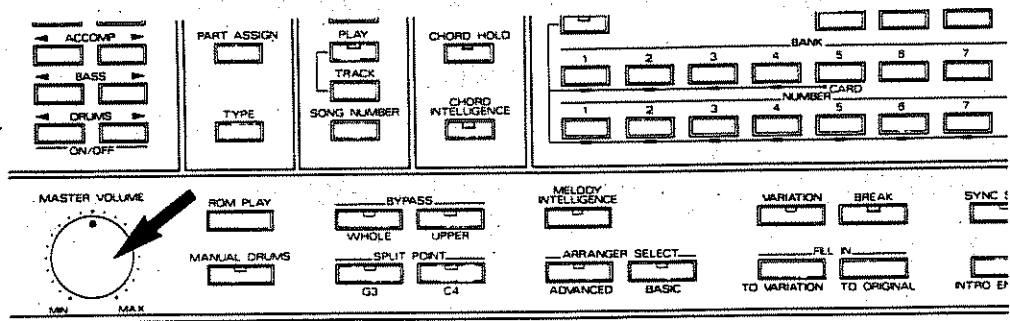

* The Master Volume knob on the Roland piano does not affect the volume of the RA-50.

* If you start ROM Play as explained above, the 1st to 5th songs are played repeatedly unless you press **START/STOP**.

* To play the second song, press **ROM PLAY** twice in step ①. Likewise, to play the third song, press **ROM PLAY** three times, and so on. In this case, the song is played only once.

* To stop ROM Play, simply press **START/STOP**.

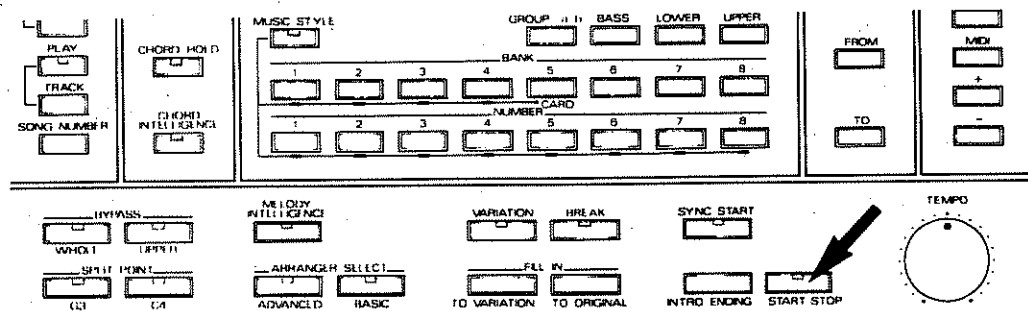

3

Let's enjoy ensemble performance

(1) Keyboard Split

When the RA-50 is switched on, the indicator located above the "C4" button in the SPLIT POINT will light up. This means that the keyboard is divided into two sections; the keyboard higher than C4 to the Upper Part (right-hand keyboard) and the keyboard lower than B3 to the Lower Part (left-hand keyboard). (For details of Split, refer to page 24 in the third chapter.)

The Upper Tone is default to "11 ELEC PIANO 1", the Lower Tone to "42 STRING SECT 2" and the Bass Tone to "71 ACOU BASS 1".

Now, select "35 TROMBONE 1" for the Upper Tone and "21 ELEC ORGAN 1" for the Lower Tone to play the example score.

① Press **UPPER** in the MUSIC STYLE/TONE SELECT section.

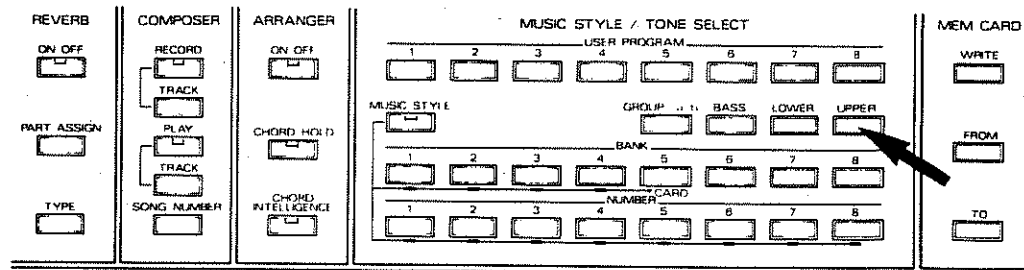

② Press **BANK 3**.

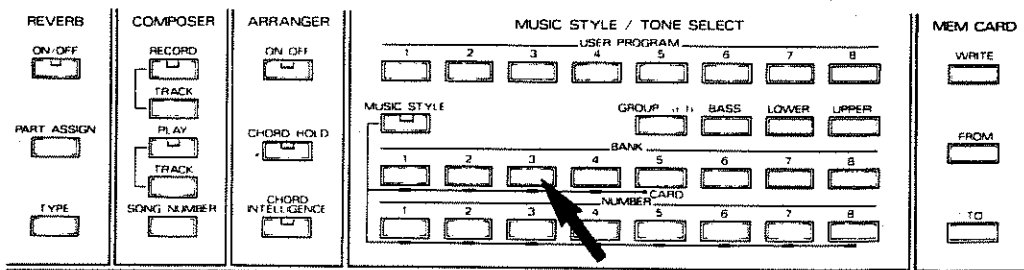

③ Press NUMBER **5**.

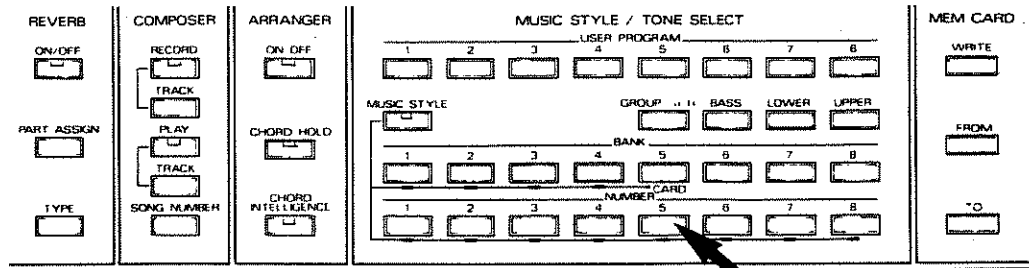

* The number of UPP in the display will change to "35". (If a different number is shown, repeat steps ② and ③.)

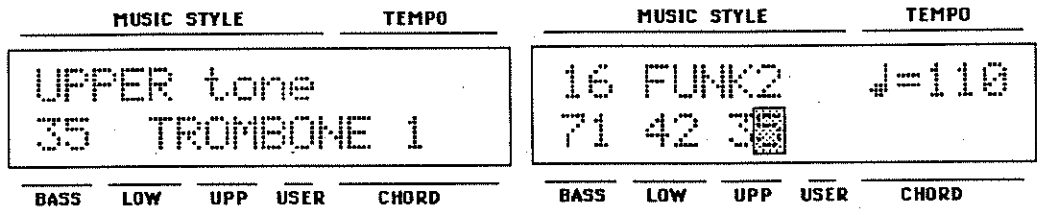

④ Press **LOWER** that is located next to **UPPER**.

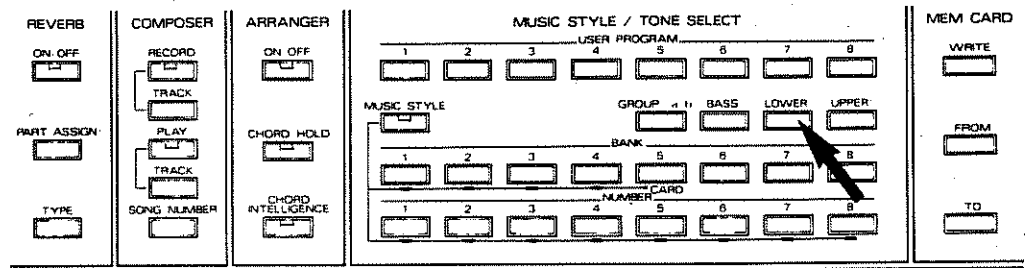

⑤ Press BANK **2**.

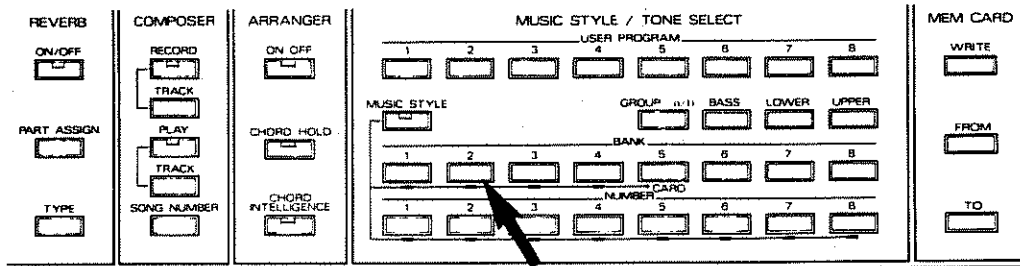

⑥ Press NUMBER **1**.

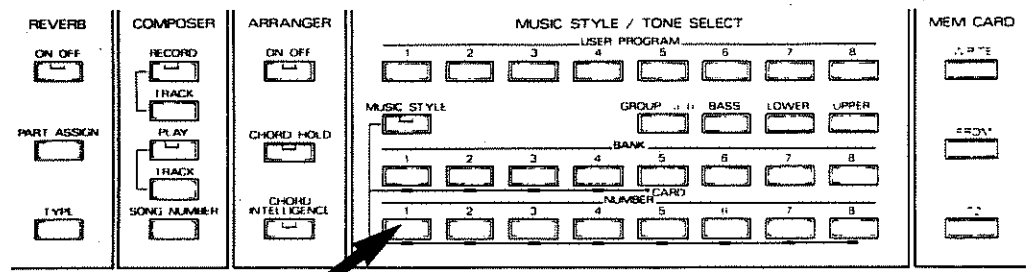

*The number of LOW in the display will change to "21". (If a different number is shown, repeat steps ⑤ and ⑥.)

MUSIC STYLE				TEMPO		MUSIC STYLE				TEMPO	
LOWER tone						16 FUNK2				♩=110	
21 ELEC ORGAN1						71 2 35					
BASS	LOW	UPP	USER	CHORD		BASS	LOW	UPP	USER	CHORD	

⑦ Play the keyboard.

(2) Listening to the rhythm

Various different rhythms can be played on the RA-50. Now, we play "44 CHA CHA" rhythm.

① Press **MUSIC STYLE**.

② Press **BANK 4**.

③ Press **NUMBER 4**.

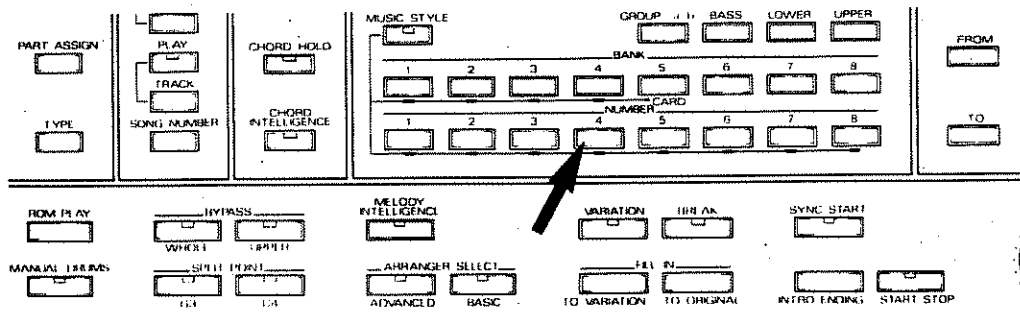

④ Press **START/STOP**.

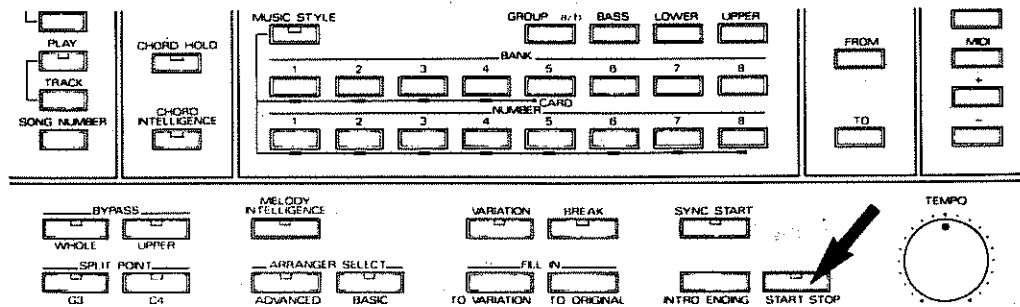

* A desired rhythm can be selected using the 1 to 4 BANK buttons and 1 to 8 NUMBER buttons. You may play different rhythms. For details of rhythm, refer to page 29 in "2 Rhythm and Music Style" in the third chapter.

(3) Accompaniment

a. Chord Intelligence

This function can distinguish the chord by playing only a part of a chord.

① Press **CHORD INTELLIGENCE** and make sure that the indicator lights up.

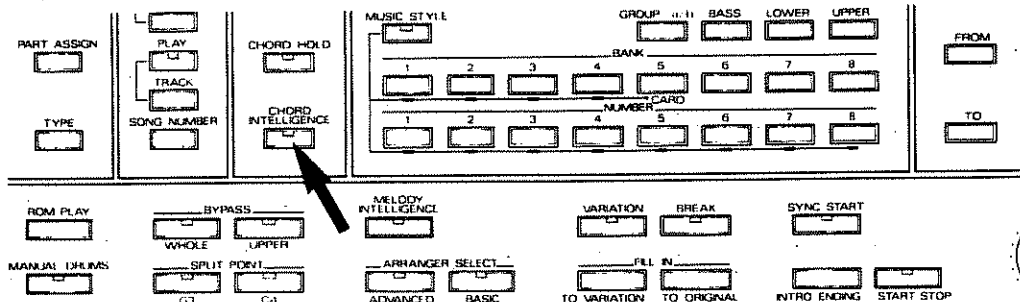

② Press **ARRANGER ON/OFF** and make sure that the indicator lights up.

③ Press **SYNC START**

④ Play the piano (Lower Part).

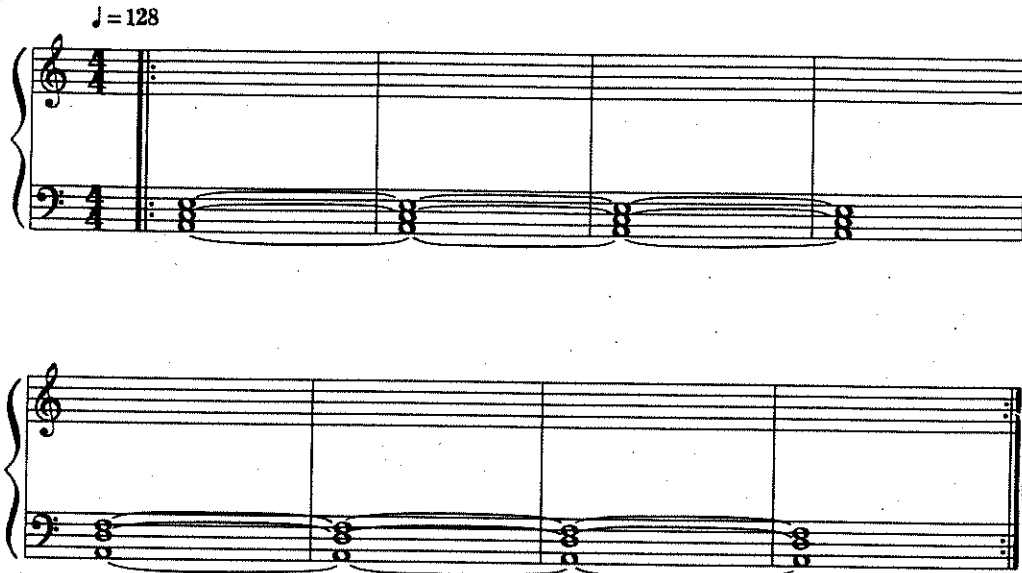

b. Melody Intelligence

Now, you can add harmony to the melody played in single note.

- ① Press **MELODY INTELLIGENCE** and make sure that the indicator lights up.

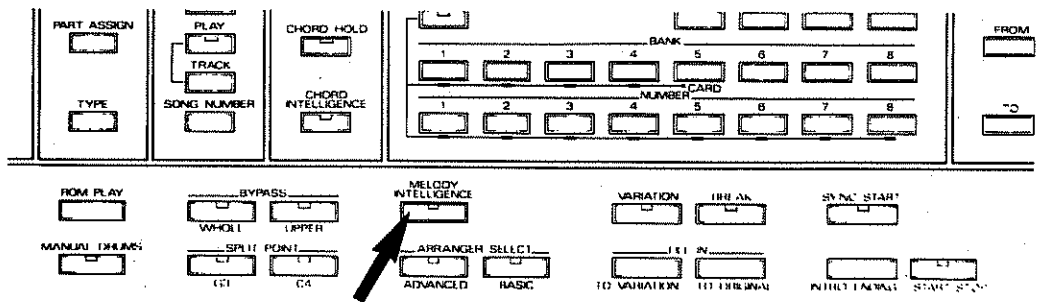

- ② Play the chord with the left hand (naturally, the Chord Intelligence function can be used) and play the melody with the right hand.

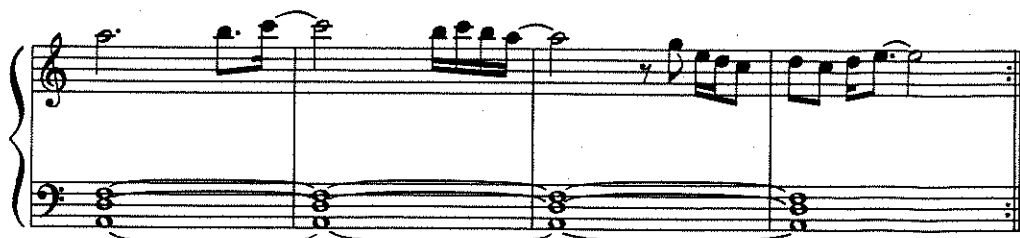

2

BEFORE PLAYING THE RA-50

TO USE THE RA-50 IN THE BEST CONDITION.

1

Panel Description

(1) Front Panel

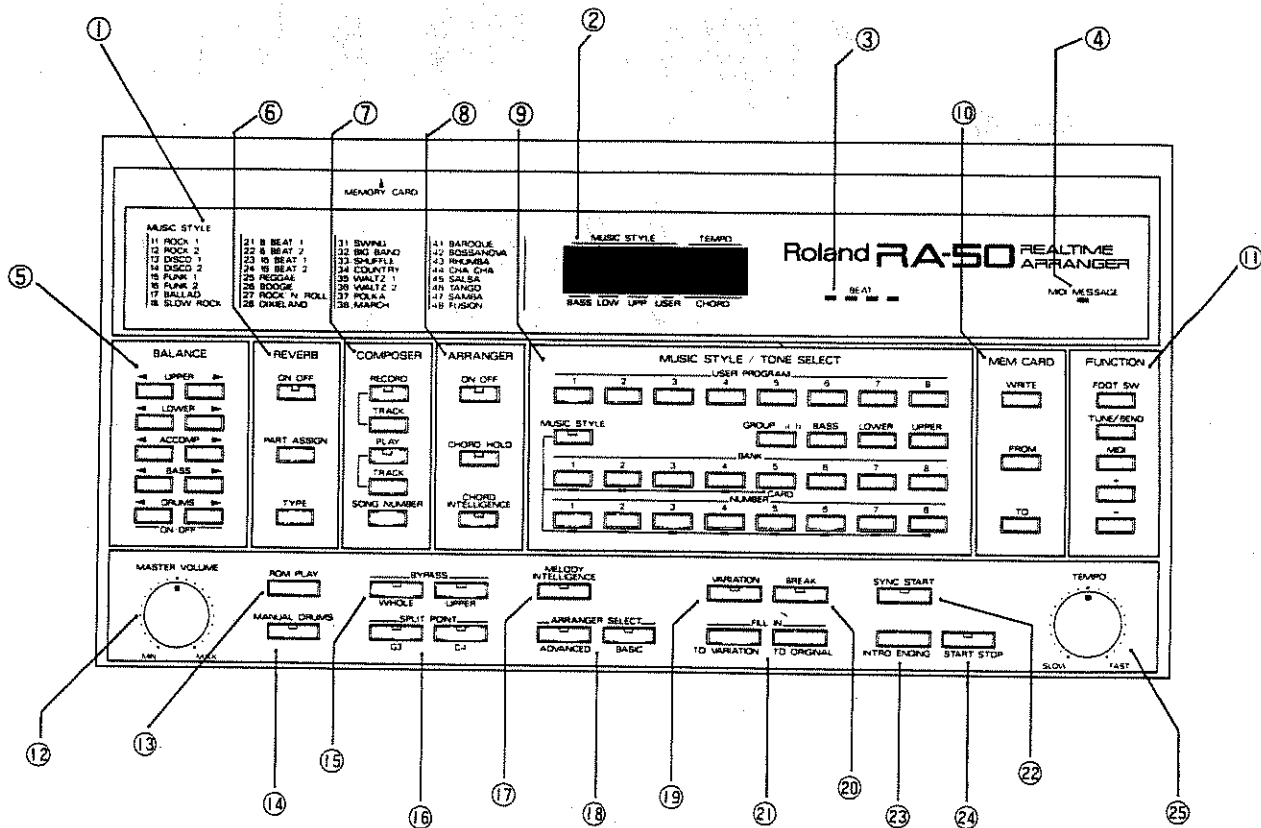

(2) Rear Panel

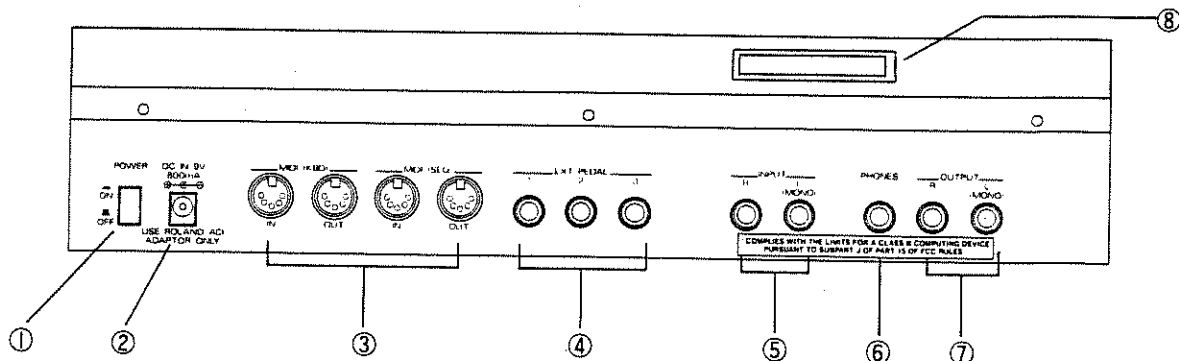

● Front Panel

- ① **Music Style List**
- ② **Display**.....shows the current condition of the RA-50 or instructions for you to follow.
- ③ **Beat Indicator**.....the indicator flashes to tell you what beat is currently being played.
- ④ **MIDI Message Indicator**.....this lights when any MIDI messages are received.
- ⑤ **BALANCE**.....controls the volume of each Part for ensemble performance.
- ⑥ **REVERB (Reverberation)**.....controls the reverb effect.
- ⑦ **COMPOSER**.....use this for recording or playing back your performance data.
- ⑧ **ARRANGER**.....this allows you to select an ideal auto-accompaniment that suits the played chord and selected Music Style.
- ⑨ **MUSIC STYLE/TONE SELECT**.....use this to select a desired Music Style (music genre) and Tone.
- ⑩ **MEM CARD**.....use this for saving data onto a memory card or loading data on a memory card back to the RA-50 memory.
- ⑪ **FUNCTION**.....this allows you to set parameters related with foot switch, tuning, pitch bend and MIDI.
- ⑫ **MASTER VOLUME knob**.....this controls the volume. The headphones volume is also controlled with this knob.
- ⑬ **ROM PLAY**.....used this to play the five preprogrammed demonstration songs.
- ⑭ **MANUAL DRUMS**.....you can enjoy drum solo performance by playing the keyboard.
- ⑮ **BYPASS**.....you can select whether to play the RA-50's built-in sound module or the sound source of the connected keyboard.
- ⑯ **SPLIT POINT**.....this determines the position where the keyboard is split into two parts, Upper and Lower.
- ⑰ **MELODY INTELLIGENCE**.....this can add harmony to the melody you play (in the Split mode).
- ⑱ **ARRANGER SELECT**.....this selects an accompaniment type (Basic or Advanced).
- ⑲ **VARIATION**.....this selects the advanced type accompaniment.
- ⑳ **BREAK**.....this makes a space of silence in the middle of a performance.
- ㉑ **FILL IN**.....this can put fill in in the middle of a song.
- ㉒ **SYNC START**.....this starts playing the moment you play the keyboard.
- ㉓ **INTRO/ENDING**.....this inserts specific patterns at the beginning and end of the performance.
- ㉔ **START/STOP**.....this starts or stops playing.
- ㉕ **TEMPO knob**.....this changes the tempo of song.

● Rear Panel

- ① **POWER**.....this switches on or off the unit.
- ② **DC IN**.....connect an AC adaptor to this socket.
- ③ **MIDI Sockets**.....these are MIDI sockets to connect an external MIDI device.
- ④ **EXT PEDAL**.....connect a foot switch (optional : DP-2/6, FS-5U) to this socket.
* A foot switch (unlatch type), damper pedal or pedal switch will function in exactly the same way on the RA-50.
- ⑤ **INPUT**.....this receives audio signal from an external device, mix it with the audio signal of the RA-50 itself, then output the mixed signal from the OUTPUT socket.
- ⑥ **PHONES (headphones) socket**.....connect headphones to this socket.
- ⑦ **OUTPUT**.....this output the RA-50's audio signal.
- ⑧ **MEMORY CARD slot**.....insert a MUSIC STYLE CARD (optional : TN-SCI-01 ~ 07, etc.) or MEMORY CARD (optional : M-256E) to this slot.

2

Important Notes

- When employing an AC adaptor, make certain you use only one that has been supplied by the manufacturer. Use of any other power adaptor could result in malfunction or damage.
- When you make any connections with other devices, always turn off the power to all equipment first. This will help in preventing malfunction, and damage to speakers.
- Do not force the unit to share the same power outlet as one used for distortion producing devices (such as motors, variable lighting devices). Be sure to use a separate power outlet.
- Before using the AC adaptor, always make certain the voltage of the available power supply conforms to its rating.
- Do not place heavy objects onto, step on, or otherwise risk causing damage to the power cord.
- Whenever you disconnect the AC adaptor from the outlet, always grasp it by plug, to prevent internal damage to the cord and hazard of possible short circuits.
- If the unit is not to be used for a long period of time, unplug the cord from the socket.
- Avoid using or storing the unit in the following places, as damage could result.
 - Places subject to extremes in temperature. (Such as under direct sunlight, near heating units, above equipment generating heat, etc.)
 - Places near water and moisture. (Baths washrooms, wet floors, etc.) Places otherwise subject to high humidity.
 - Dusty environments.
 - Places where high levels of vibration are produced.
- Placing the unit near power amplifiers or other equipment containing large transformers may induce hum.
- Should the unit be operated nearby television or radio receivers, TV pictures may show signs of interference, and static might be heard on radios. In such cases, move the unit out of proximity with such devices.
- For everyday cleaning, wipe the unit with a soft dry cloth, or one that is dampened slightly. To remove dirt that is more stubborn, wipe using a mild, neutral detergent. Afterwards, make sure to wipe thoroughly with a soft cloth.
- Never apply benzene, thinners, alcohol or any like agents, to avoid the risk of discoloration and deformation.
- Protect the unit from strong impact
- Avoid getting any foreign objects (coins, wire, etc.) or liquids (water, drinks, etc.) into the unit.
- NEVER apply strong pressure to the display, or strike it in any way.
- At any time that you notice a malfunction, or otherwise suspect there is damage, immediately refrain from using the unit. Then contact the store where bought, or the nearest Roland Service Station.
- Within the unit is contained a battery which serves in maintaining the contents of memory while the main power is off. The normal life of this battery is 5 years or more, but it is strongly recommended that you change it every 5 years as a rule. When it is time to change the battery, contact a Roland Service Station. The first time you need to change the battery could occur before 5 years have passed.
- When the battery gets weak the following will appear in the display. By this time, it is possible that the contents of memory have already been lost. "CHECK INTERNAL BATTERY"
- Please be aware that the contents of memory may at times be lost ; when sent for repairs or when by some chance a malfunction has occurred. Important data should be saved on an optional memory card (M-256E), or written down on paper. During repairs, due care is taken to avoid the loss of data, however, in certain cases, such as when circuitry related to memory itself is out of order, we regret that it may be impossible to restore the data.

3 Connections

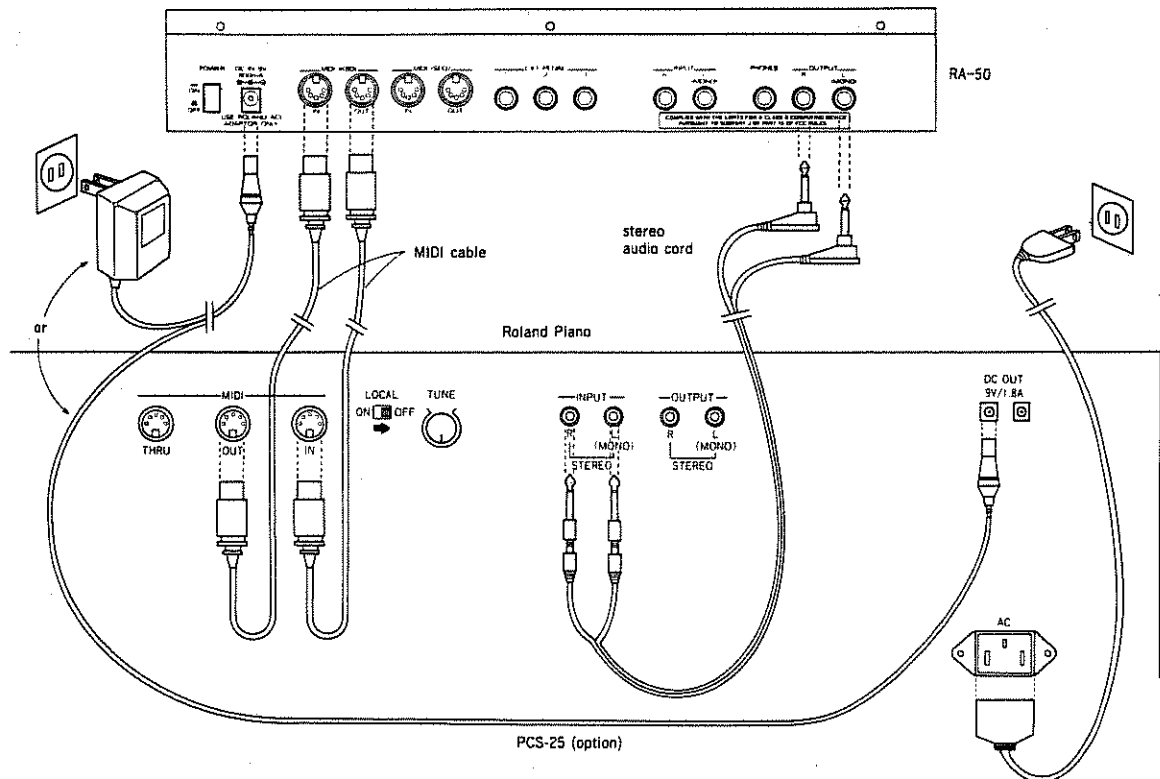

The MIDI receive channel of the RA-50 has been set to "1" from the manufacturer. Normally, a Roland piano is default to MIDI channel 1, so that you do not need to change MIDI channels. However, if the MIDI channel on the Roland piano is fixed to a different number, change the Upper and Lower's receive channels on the RA-50 to 1 as explained on page 72 "1 Setting MIDI Functions" in chapter 5.

Even when the piano is set to Local OFF, the Bypass function allows you to play the piano on its own without switching the RA-50 off. (For detailed explanation, read page 72 "1 Setting the MIDI Functions" in chapter 5.)

If the RA-50 is not correctly tuned to the connected piano, the pitch of the sound created by piano with the Bypass function on will differ from the RA-50's. How to adjust the RA-50's tuning is explained on page 65 "(1) Tuning" in chapter 4.

When you disconnect the RA-50 from the piano and play the piano on its own, return the Local Switch on the piano to the ON position.

4

Outline of the RA-50

(1) What is the RA-50 ?

RA-50 is an arranger that arranges the music you play on your electronic piano or MIDI keyboard. It also features various sounds such as a guitar, violin, trumpet, bass and drums, and therefore can become a player. In other words, it is an orchestra with a conductor that allows you to play melody or ad-lib to the excellent accompaniment.

You may consider it difficult to create music or compose a song. When you wish to make a song from the melody you happen to hear, you cannot think of how to make the accompaniment, how to play the phrase, how to play the drums, etc. Now that you have the RA-50, there is nothing to worry about. Simply select the music genre you like, give the melody and chord process, and the RA-50 will arrange it and add excellent accompaniment and harmony, if you like. The RA-50 is not only intelligent as above but also is an excellent player. The RA-50 adopts the LA synthesis which is greatly supported by professional musicians in the D-50 and other D-series, and therefore creates high quality sounds; from realistic acoustic sounds to synthesizer sounds. It also includes a digital reverb that creates natural reverberation of a large hall. The RA-50 can record your performance just like a tape recorder, so that you can record the melody that comes in your mind or the song you have arranged.

The RA-50's is an instrument that features great many functions. With the RA-50 and a piano, you can stand on a stage in a large hall as a keyboard player, and the RA-50 will take parts of an arranger and conductor.

(2) About "Music Style"

Music Style in this manual means accompaniment pattern that varies depending on the music genre. That is, changing the Music Style, you can use different accompaniments. Each Music Style has a name, such as Rock, Disco, Bossanova, Samba, etc.

One Music Style has Advanced and Basic types and each type has two variations, therefore, by selecting a Music Style, you can play four types of accompaniments. The accompaniment patterns change depending on the chord constructions, creating natural accompaniment along with the music. Advanced Music Style is more sophisticated accompaniment compared with the Basic. A Music Style contains patterns for two patterns of Fill in, Intro and Ending. It also contains a Tone and Tempo that match the accompaniment, so that selecting a Music Style will cover everything for successful performance.

3

BASIC PROCEDURE

ENJOY THE RA-50 THOROUGHLY.

1

How to enjoy the Split Performance

(1) Split Function and Tone Assignment

Using the RA-50's Split function, you can enjoy ensemble performance with different Tones assigned to the upper (right-hand) and lower (left-hand) keyboard.

The keyboard is divided into two sections at the Split Point where the indicator is lit. The upper keyboard includes the Split Point.

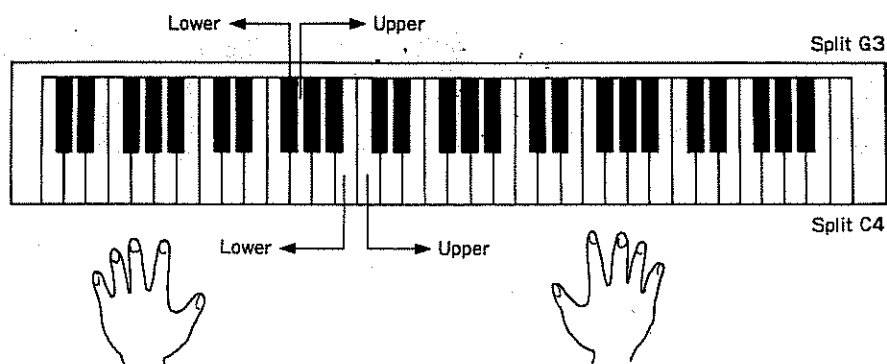

* Normally, the Split Point is set to C4 at power up. This means that the right keyboard including C4 key is the Upper Part and the left keyboard from B3 key is the Lower Part.

● To change the Split Point to G3, press **G3**. The relevant indicator lights up. Now, the right keyboard from G3 key is the Upper Part and the left keyboard from F#3 key is the Lower Part.

● To cancel the Split and use the entire keyboard with one Tone, press the button currently lit.

(2) Tone List

TONE #		TONE NAME
1	A 11	Electric Piano 1
2	A 12	Electric Piano 2
3	A 13	Electric Piano 3
4	A 14	Honkytonk
5	A 15	Harpsichord 1
6	A 16	Clavi 1
7	A 17	Celesta 1
8	A 18	Harp 1
9	A 21	Electric Organ 1
10	A 22	Electric Organ 2
11	A 23	Electric Organ 3
12	A 24	Pipe Organ 1
13	A 25	Pipe Organ 2
14	A 26	Breathpipe
15	A 27	Shakuhachi
16	A 28	Accordion
17	A 31	Synth Brass 1
18	A 32	Synth Brass 2
19	A 33	Synth Brass 3
20	A 34	Trumpet 1
21	A 35	Trombone 1
22	A 36	French Horn 1
23	A 37	Brass Section 1
24	A 38	Saxophone 1
25	A 41	Strings Section 1
26	A 42	Strings Section 2
27	A 43	Pizzicato
28	A 44	Violin 1
29	A 45	Orchestra Hit
30	A 46	Chorale
31	A 47	Soundtrack
32	A 48	Whistle 1

33	A 51	Fantasy
34	A 52	Atmosphere
35	A 53	Warm Bell
36	A 54	Echo Bell
37	A 55	Water Bells
38	A 56	Echo Pan
39	A 57	Doctor Solo
40	A 58	Square Wave
41	A 61	Guitar 1
42	A 62	Guitar 2
43	A 63	Electric Guitar 1
44	A 64	Electric Guitar 2
45	A 65	Flute 1
46	A 66	Pan Pipes
47	A 67	Clarinet 1
48	A 68	Harmonica
49	A 71	Acoustic Bass 1
50	A 72	Acoustic Bass 2
51	A 73	Electric Bass 1
52	A 74	Slap Bass 1
53	A 75	Slap Bass 2
54	A 76	Fretless Bass 1
55	A 77	Fretless Bass 2
56	A 78	Contrabass
57	A 81	Vibraphone 1
58	A 82	Vibraphone 2
59	A 83	Glockenspiel
60	A 84	Xylophone
61	A 85	Marimba
62	A 86	Jungle Tune
63	A 87	Ice Rain
64	A 88	Telephone

65	B 11	Acoustic Piano 1
66	B 12	Acoustic Piano 2
67	B 13	Acoustic Piano 3
68	B 14	Electric Piano 4
69	B 15	Electric Organ 4
70	B 16	Pipe Organ 3
71	B 17	Harpsichord 2
72	B 18	Harpsichord 3
73	B 21	Clavi 2
74	B 22	Clavi 3
75	B 23	Celesta 2
76	B 24	Synth Brass 4
77	B 25	Synth Bass 1
78	B 26	Synth Bass 2
79	B 27	Synth Bass 3
80	B 28	Synth Bass 4
81	B 31	Harmo Pan
82	B 32	Glasses
83	B 33	Funny Vox
84	B 34	Oboe 2001
85	B 35	Schooldaze
86	B 36	Bellsinger
87	B 37	Strings Section 3
88	B 38	Violin 2
89	B 41	Cello 1
90	B 42	Cello 2
91	B 43	Harp 2
92	B 44	Sitar
93	B 45	Electric Bass 2
94	B 46	Flute 2
95	B 47	Piccolo 1
96	B 48	Piccolo 2
97	B 51	Recorder
98	B 52	Saxophone 2
99	B 53	Saxophone 3
100	B 54	Saxophone 4
101	B 55	Clarinet 2
102	B 56	Oboe
103	B 57	English Horn
104	B 58	Bassoon
105	B 61	Trumpet 2
106	B 62	Trombone 2
107	B 63	French Horn 2
108	B 64	Tuba
109	B 65	Brass Section 2
110	B 66	Synth Mallet
111	B 67	Wind Bell
112	B 68	Tube Bell
113	B 71	Koto
114	B 72	Sho
115	B 73	Whistle 2
116	B 74	Bottleblow
117	B 75	Timpani
118	B 76	Melodic Tom
119	B 77	Deep Snare
120	B 78	Electric Percussion 1
121	B 81	Electric Percussion 2
122	B 82	Taiko
123	B 83	Taiko Rim
124	B 84	Cymbal
125	B 85	Castanets
126	B 86	Triangle
127	B 87	Bird Tweet
128	B 88	One Note Jam

(3) Tone Selection for Upper Part

① Press **UPPER** in the MUSIC STYLE/TONE SELECT section.

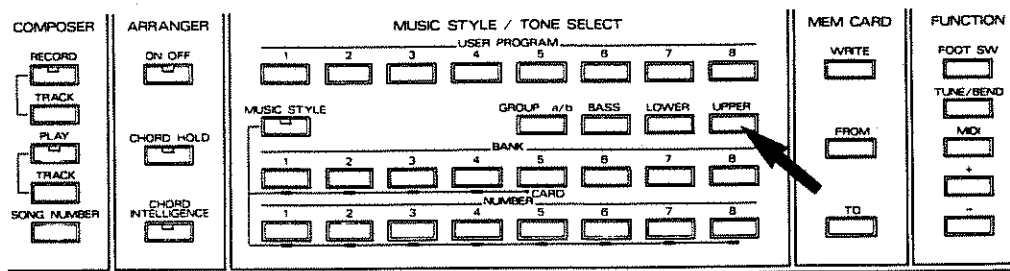

② Press **GROUP a/b**.

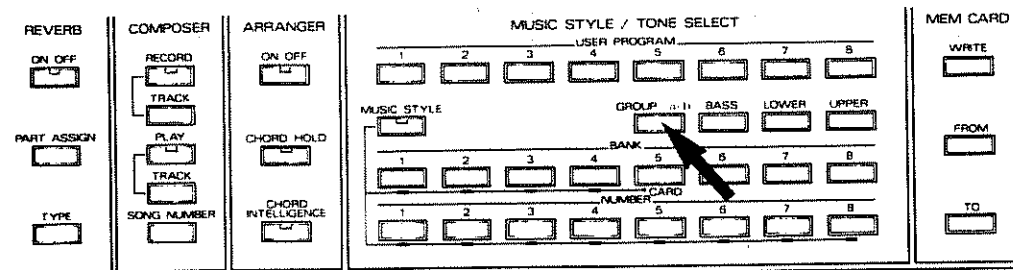

③ A Tone is represented with a two figure number. Press the **BANK** button for the left figure. (Press Bank button 2 if the Tone Number is 25).

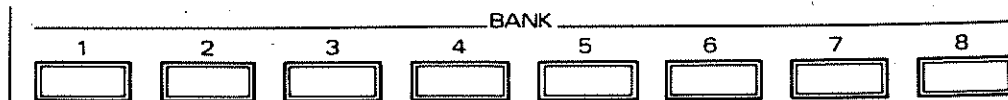

④ Press the **NUMBER** button for the right figure. (Press Number button 5 if the Tone Number is 25.)

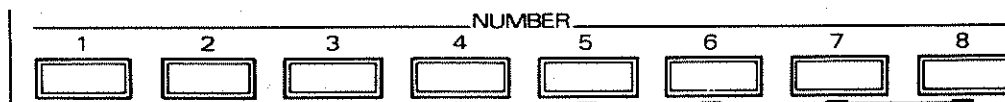

* The number shown above UPP in the display is the selected Tone. (If you do not proceed the above steps quickly, the display will return to the previous indication. If this happens, repeat steps ②, ③ and ④.)

* While the cursor is flashing at the UPP position in the display (after **UPPER** is pressed), you can change Upper Tones by taking steps ②, ③ and ④.

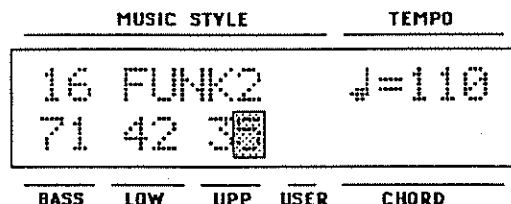

NOTE) The flashing position in the display is called cursor.

* You may take steps ②, ③ and ④ in a different order.

(4) Tone Selection for Lower Part

① Press **LOWER** in the MUSIC STYLE/TONE SELECT section.

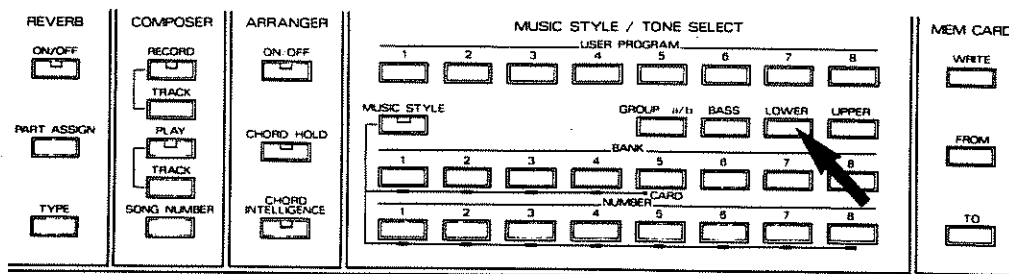

② Press the **BANK** button to select a Tone.

③ Press the **NUMBER** button.

* The number shown above LOW in the display is the new Tone Number. (If you do not proceed the above steps quickly, the display will return to the previous indication. If this happens, repeat steps ② and ③.)

* While the cursor is flashing at the LOW position in the display (after **LOWER** is pressed), you can change Lower Tones by taking steps ② and ③.

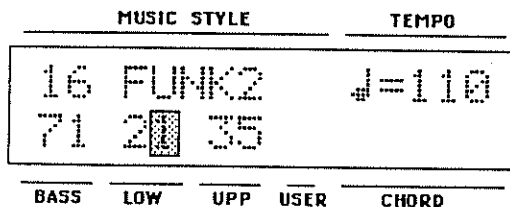

* You may take steps ② and ③ in a different order.

(5) Notes on tone selecting

* Any of the 128 different Tones can be used for the Upper Tone.

* Any of the 128 different Tones can be used for the Lower Tone.

* Both Upper and Lower Tones can be changed even while music is being played.

● Any of the 128 different Tones can be used for the Bass Tone. Press **BASS** in the MUSIC STYLE/TONE SELECT section, then use the **BANK** and **NUMBER** buttons to assign the Tone Number. However, when the rhythm has been started with the Arranger function on, the Tone that is assigned to the Music Style currently used will be automatically used for the Bass, and you cannot use any other Tone. (For detailed explanation about the Arranger function, see page 35 "Arranger" in chapter 3, and about the Music Style, read the following "2 Rhythm and Music Style".

2

Rhythm and Music Style

There are various different music genres, such as Classical music, Jazz, Rock etc. There are some common features for all music in the same genre. Rhythm is one of the common features. Rhythm, tempo and accompaniment instrument and arrangement will determine the music. Music Style consists of all these elements.

Four Elements included in a Music Style

Rhythm.

Tempo that matches the rhythm (Preset Tempo).

Accompaniment instrument that matches the rhythm (Tone).

Arrangement that matches the rhythm (Arranger).

The RA-50 is accompanied with 32 different Music Styles (4 Banks × 8 Numbers : the same number as the rhythms). You may use the optional Music Style Card to extend the number of Music Styles.

If you select a Music Style with the Arranger function off, the rhythm and tempo that matches the rhythm will be automatically set. Playing the Music Style will play only the rhythm with the preset tempo like a rhythm machine. (You can play the keyboard to the rhythm, if you like.) If you select a Music Style with the Arranger function on, the four elements will be automatically set. Therefore, complete form of the performance will be automatically played. This is called "Style Performance".

A Music Style includes bass/chord/accompaniment for the use of drum pattern/basic tempo and arranger. Also, a basic rhythm (original) and modified rhythm (variation) are set for the drum pattern and a basic arrange type (basic) and advanced type (advanced) are set for the accompaniment. Therefore, a Music Style can be played in four different variations, that is, 128 different patterns are prepared in the internal memory of the RA-50.

(1) Music Style List

11 ROCK 1	21 8 BEAT 1	31 SWING	41 BAROQUE
12 ROCK 2	22 8 BEAT 2	32 BIG BAND	42 BOSSANOVA
13 DISCO 1	23 16 BEAT 1	33 SHUFFLE	43 RHUMBA
14 DISCO 2	24 16 BEAT 2	34 COUNTRY	44 CHA CHA
15 FUNK 1	25 REGGAE	35 WALTZ 1	45 SALSA
16 FUNK 2	26 BOOGIE	36 WALTZ 2	46 TANGO
17 BALLAD	27 ROCK'N'ROLL	37 POLKA	47 SAMBA
18 SLOW ROCK	28 DIXIELAND	38 MARCH	48 FUSION

The same Music Style List is shown at the upper left on the front of the RA-50.

(2) Selecting a Music Style

① Press **MUSIC STYLE**.

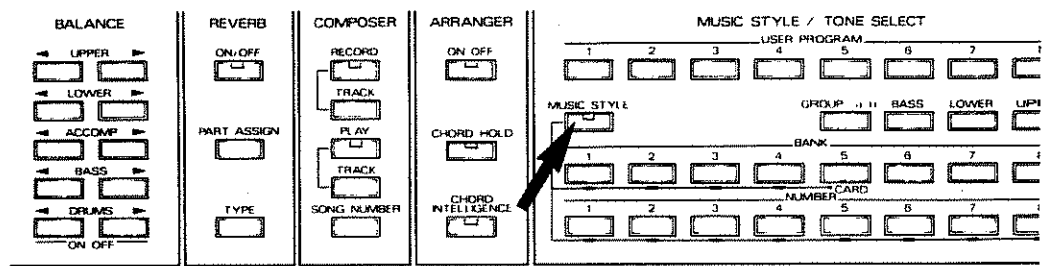

② Select a Music Style using a **BANK** button (1 ~ 4) and **NUMBER** button (1 ~ 8).

* You can press either of the **BANK** or **NUMBER** button first.

* When the cursor has been moved to the position of the Music Style Number using **MUSIC STYLE**, a different Music Style can be selected simply by taking step ②.

* To select a Music Style in the internal memory of the RA-50, only 1 to 4 **BANK** buttons can be used.

* Even while a Music Style is being played, you can select a different Music Style. However, the tempo remains unchanged.

(3) Music Style Card

The RA-50's internal memory stores 32 different Music Styles. The optional music style card (TN-SC1-01 ~ 07, etc.) allows you to use even more Music Styles. The Music Styles loaded from the Music Style Card can be played in the same way as the internal ones.

- 1 Insert the Music Style Card into the card slot on the RA-50.

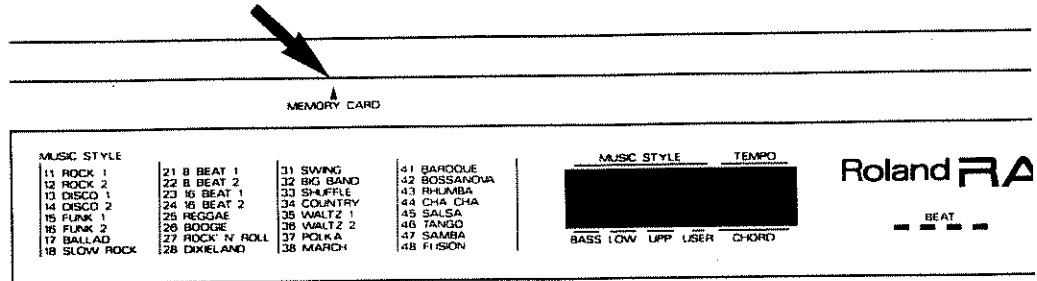

- 2 Press **MUSIC STYLE**.

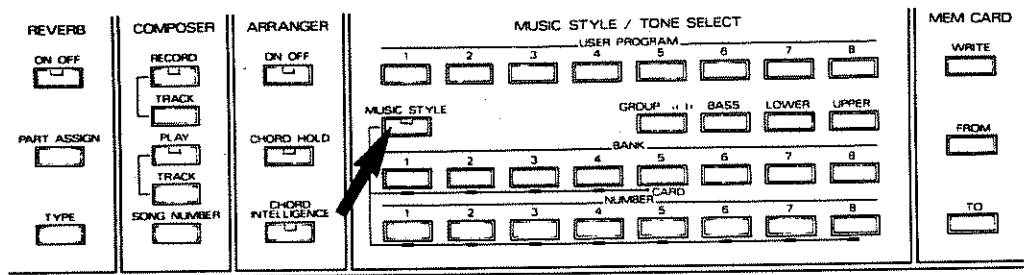

- 3 Press **BANK** button **CARD 5**.

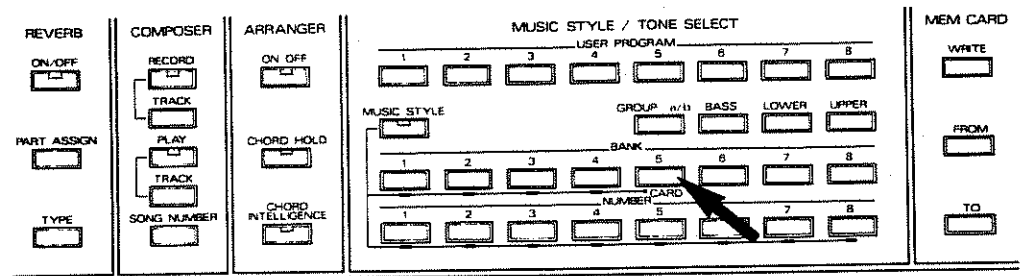

- 4 Assign the Music Style you wish to play using the appropriate **NUMBER** button.

* If you use a Music Style Card storing four rhythms, 1 to 4 patterns are exactly the same as 5 to 8 patterns.

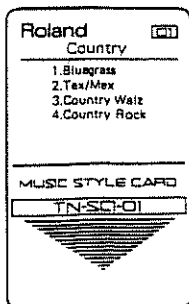

(4) Starting the Music Style

There are four different methods of starting to play a Music Style.

a. Immediate start

① Press **START/STOP**.

The moment the button is pressed, the rhythm starts playing.

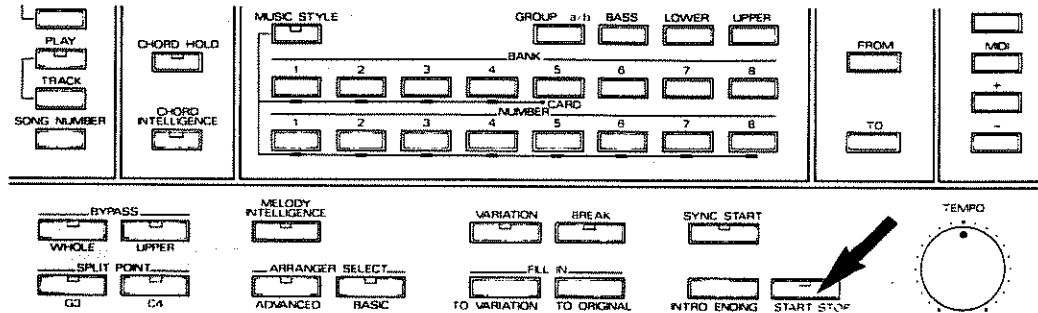

b. Sync start

① Press **SYNC START**.

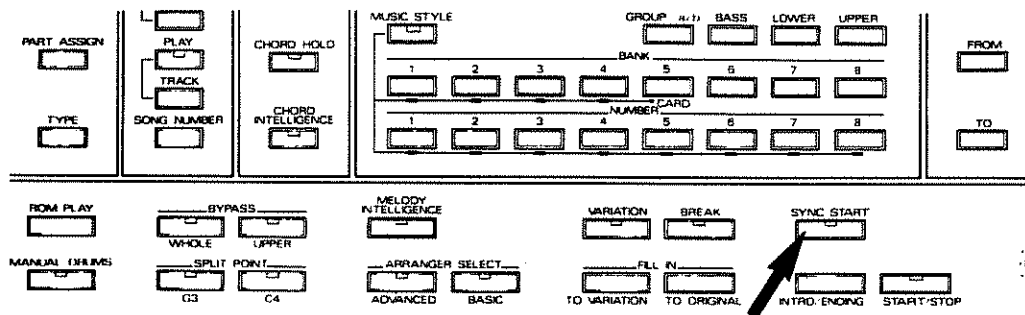

② Play the keyboard on the Lower Part.

The moment you play the keyboard, the rhythm starts playing.

* In the Sync Start Stand-by condition (right after the **SYNC START** is pressed), the Sync Indicator lights up, and it goes out the moment the rhythm starts.

* You can also start the rhythm by pressing the **START/STOP** button.

c. Start with Intro

① Press **INTRO/ENDING**.

The moment the keyboard is played, the rhythm starts with intro.

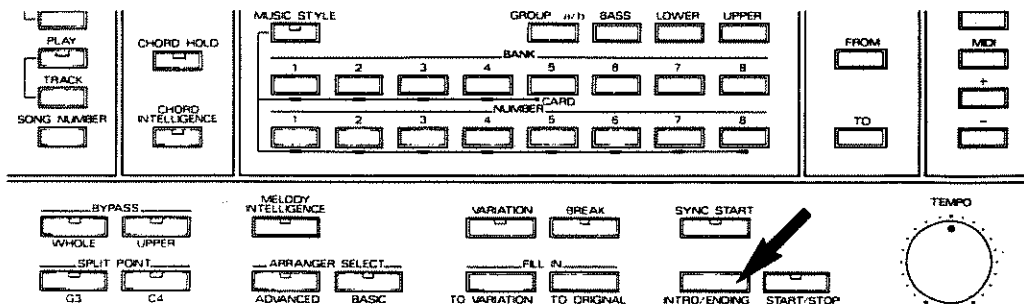

* The length of the Intro varies depending on the Music Style you select.

d. Sync start with intro

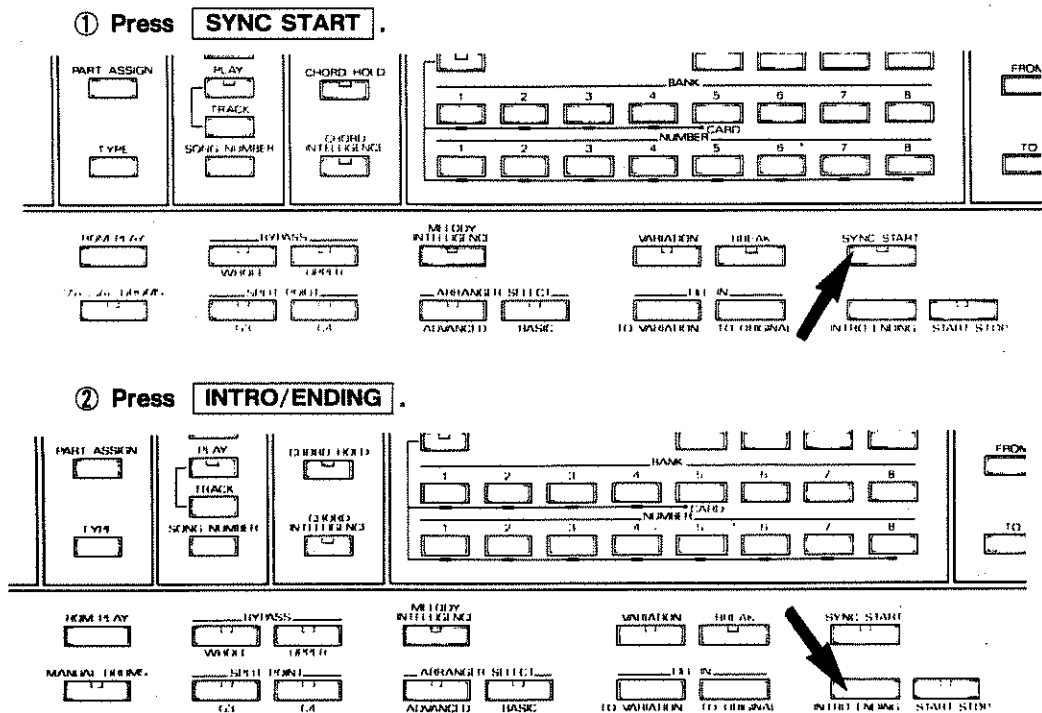

③ Play the keyboard on the Lower Part.

The moment the keyboard is played, the rhythm starts with intro.

- * In the stand-by condition (right after **SYNC START** is pressed), the Sync Indicator lights up, and it goes out the moment the rhythm starts.
- * You can also start the rhythm by pressing the **START/STOP** button.
- * The length of the intro varies depending on the Music Style you select.

(5) Stopping the Music Style

There are two methods of stopping the Music Style.

a. Immediate start

① Press **START/STOP**.

The moment the button is pressed, the rhythm stops playing.

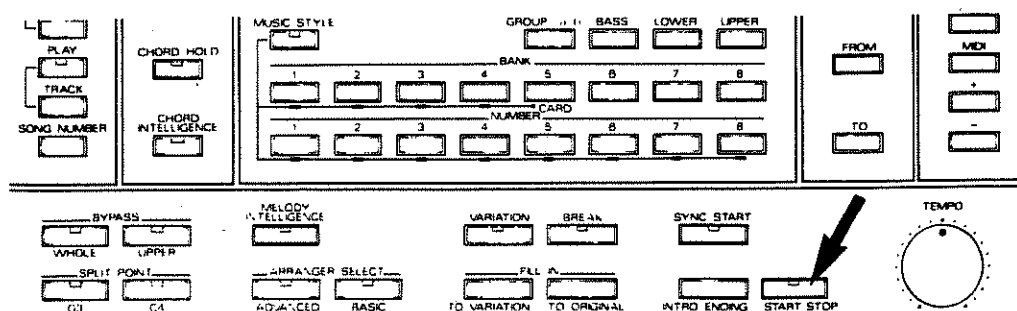

b. Stop with Ending

① Press **INTRO/ENDING**.

The ending starts from the first accent (the first beat of a bar) and the song stops at the end of the ending.

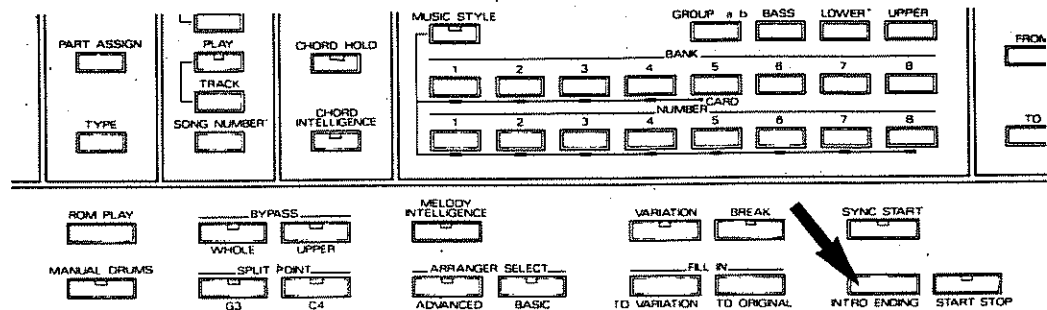

* The length of the ending varies depending on the Music Style you select.

(6) Tempo Change

The tempo can be changed using the TEMPO knob. The tempo is shown under TEMPO in the display as "♩=120". This means that as many as 120 quarter notes are played per minute. The variable range of tempo is ♩=32 to 250.

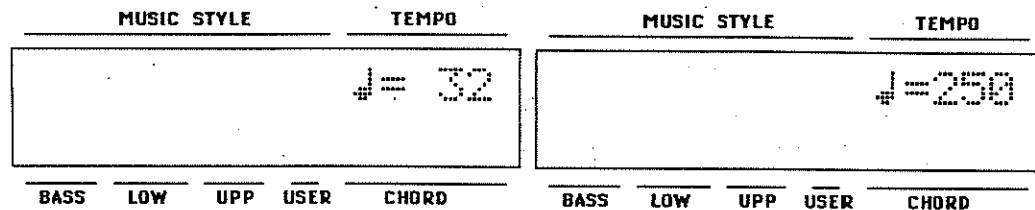

● Change the tempo using the TEMPO knob.

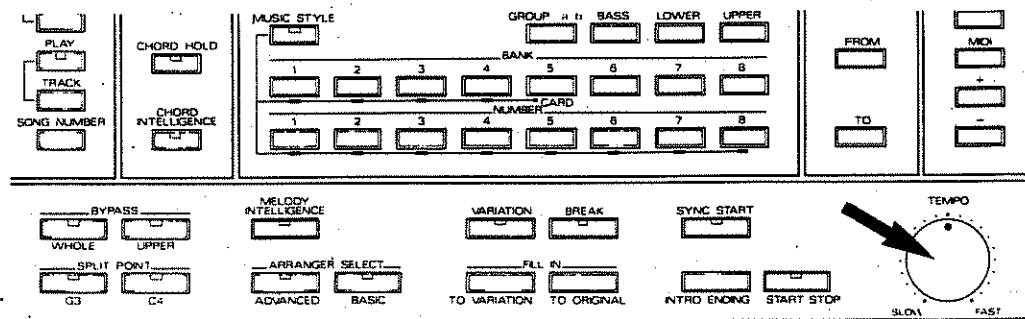

* Rotating the TEMPO knob clockwise will quicken the tempo.

* The tempo may not change by rotating the TEMPO knob slightly. If this happens, rotate the knob drastically once. Each Music Style has a different tempo and that is why the tempo does not change unless the TEMPO knob should be moved up to the preset tempo value.

3

Arranger

(Automatic Accompaniment Playing)

The RA-50's accompaniment is automatic accompaniment played with the Arranger function.

(1) Arranger Function (Automatic Accompaniment Function)

The Arranger Function distinguishes the chord pattern from a part of the chord you play on the Lower Part (within the range where the chord is detectable).

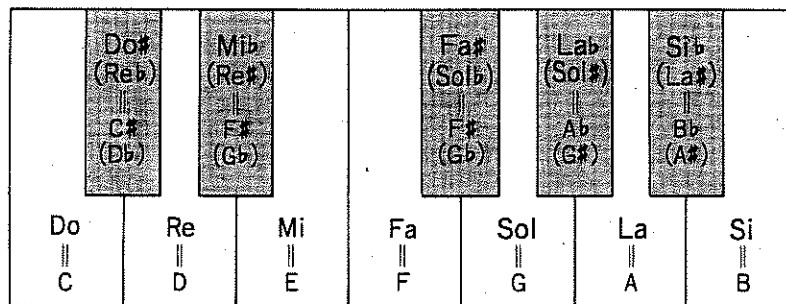

When a Music Style is started with the Arranger function on, the Lower Part (within the range where the chord is detectable) is automatically muted, therefore any note played will not sound. The Style performance in this case varies depending on the selected Music Style and the played chord.

(2) Chord

Chord names may be familiar to guitar players but not to those who play only the classical piano. They, however, are easy and useful once you have learned them.

Playing "la", "do", and "mi" in the Lower Part will cause the display to show "Ami" at the CHORD position. "Ami" is a chord name for the "la", "do", and "mi". The first (far-left) capital letter (C - B may be marked with # or b) is the root note of the chord and the sign or number that follows it shows the other notes of the chord, such as major or minor. (For detailed explanation about chord and the notes, see page 88 "Chord List".)

There are 12 root notes available for each chord. They are displayed as shown below.

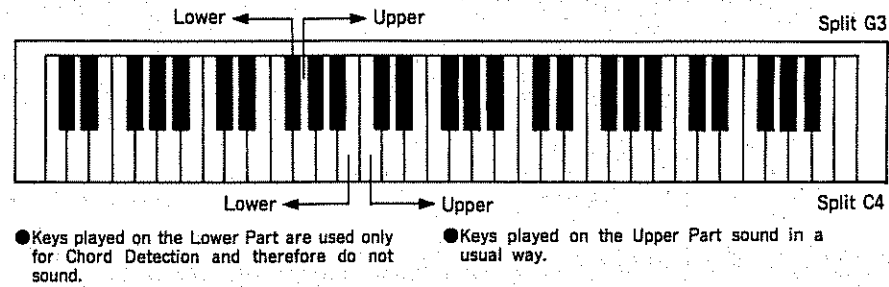

The RA-50 can distinguish and display the following 10 chords from one root note. (In the following example, the root note C is displayed.) Also, it may be displayed as shown in. < >.

<Chord Name List>

C Ma	C Major < C, Cmaj >
C mi	C Minor < Cm >
C Ma7	C Major 7th < C Δ 7, Cmaj7, CM7 >
C mi7	C Minor 7th < Cm7, C-7 >
C 7	C 7th
C ϕ	C Minor 7th Flat Five < Cm7 (\flat 5), Cm7 (-5), C-7 (-5) >
C Aug	C Augmented < C Δ 7, C (#5), C (+5) >
C Dim	C Diminished < Cdim, Cdim7, C $^{\circ}$, C $^{\circ}$ 7 >
C Su4	C Suspended 4th < C Δ 7sus4 >
C Su7	C Suspended 7th < C7sus4 >

(3) Style Performance

There are two types of automatic accompaniments played with the Arranger function; basic type arrange (BASIC) and advanced type arrange (ADVANCED). When the power is turned on, either of the arrange types is selected. (The relevant ARRANGER SELECT indicator is lit.)

① Press **ON/OFF** of ARRANGER section.

● If you wish to change arrange types, press **ADVANCED** or **BASIC** of the ARRANGER SELECT section which you desire.

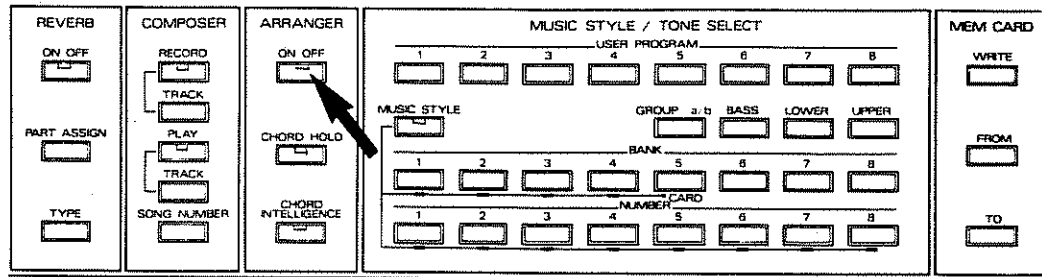

- ② Start playing the Music Style. (How to start the Music Style is explained on page 32 "(4) Starting the Music Style" in chapter 3.)
- ③ Play a chord on the Lower Part (within the chord detectable range). The RA-50 will play the Music Style currently selected and the accompaniment that matches the chord you are playing.
- ④ Stop the rhythm. (How to stop the rhythm is explained on page 33 "(5) Stopping the Music Style".)

* The muting condition of the Lower Part (the chord detectable range) is retrieved when the rhythm is stopped. However, if you stop the rhythm without releasing the keyboard, the notes being pressed are not played. To continue to play the Lower Part, play the same notes again.

(4) Variation

There are two types of rhythm patterns for Music Styles; basic rhythm (Original) and modified rhythm (Variation). Normally, you may use Original patterns, and use variations for the climax of a song.

- ① Press **VARIATION** and make sure the indicator lights up.

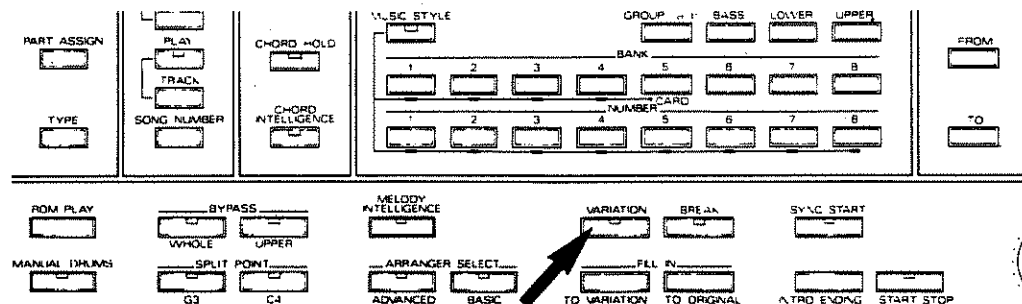

- ② To return to the Original pattern, press **VARIATION** again.

* The Variation can be turned on or off using the Fill in Function which is explained in the following section.

(5) Fill in

Fill in is a short improvisational irregular phrase (such as a drum-roll) in the song.

There are two types of Fill in for each of 32 rhythms.

a. FM in To Variation

● Press **TO VARIATION** of FILL IN section, and a bar of sophisticated fill in is played before variation rhythm of each arranger.

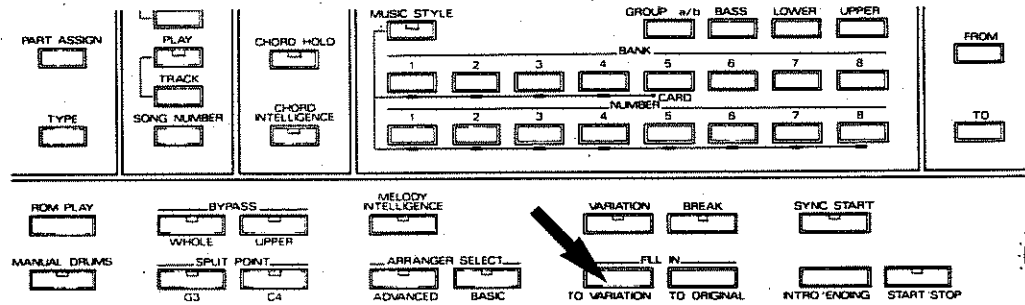

* At this stage, the VARIATION indicator lights up showing that the Variation is on.

b. Fill in To Original

● Press **TO ORIGINAL** of FILL IN, and a bar of simple fill in is played before original rhythm of each arranger.

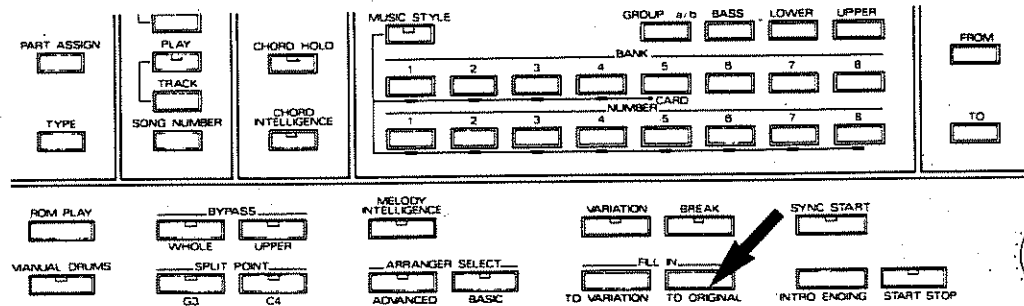

* The fill in is a bar of performance. However, depending when the Fill in button is pressed, it will be played differently.

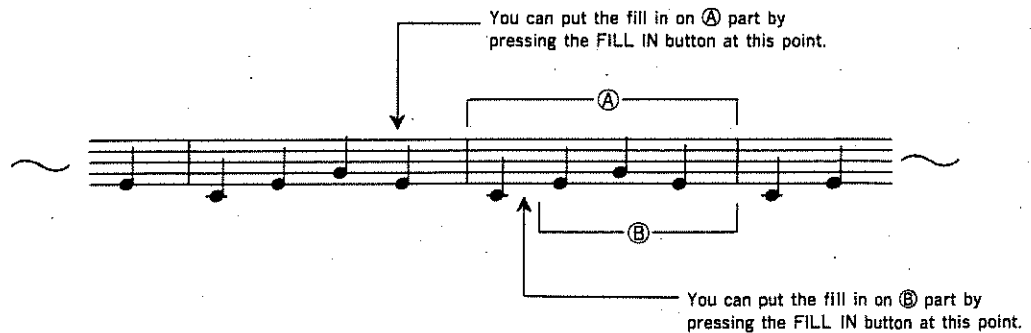

(6) Break

The RA-50's Break function makes a bar of rest in the middle of the performance, then resume playing. You may play ad-lib solo for the break (rest). This is called solo break.

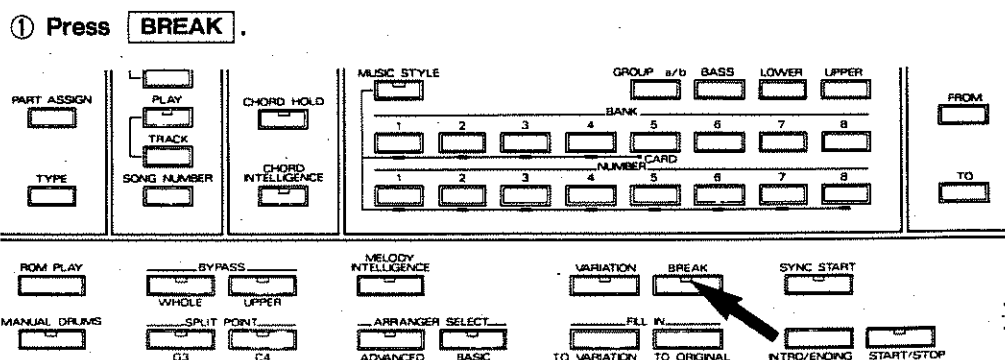

* A break is a bar of rest. However, depending when the Break button is pressed, the length of the break will vary.

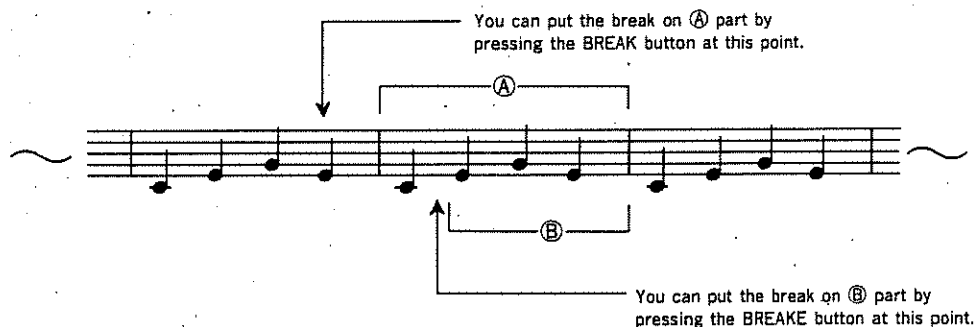

(7) Chord Hold

The Chord Hold function allows you to hold the chord played on the Lower Part until you play a new chord. Using the Chord Hold function, you can change arranger style or insert a fill in without stopping the performance.

* The Chord Hold function is effective only for the Lower Part. If you turn the Chord Hold function on with the Split off, Split Point is automatically set to C4.

① Press **CHORD HOLD** of ARRANGER and make sure the indicator lights up.

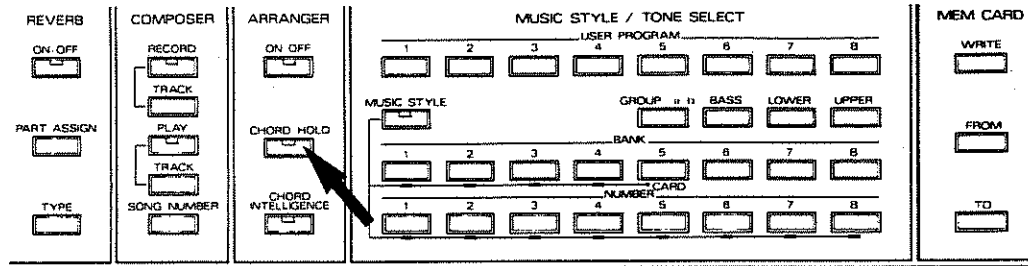

● To turn the Chord Hold function off, press **CHORD HOLD** again and check the indicator goes out.

(8) Chord Intelligence

The Chord Intelligence function can assign a correct chord even if you play only a part of the chord.

① Press **CHORD INTELLIGENCE** of ARRANGER and make sure the indicator lights up.

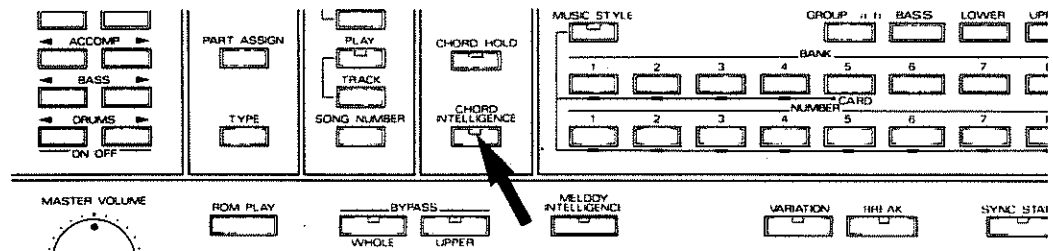

* The RA-50 can distinguish the ten types of chords from 12 root notes. (Chords that the RA-50 can distinguish are shown on page 35 "(2) Chord" in chapter 3.)

* When the chord is distinguished, the chord name is displayed. When the chord cannot be distinguished, the display shows the lowest note played on the keyboard and "****".

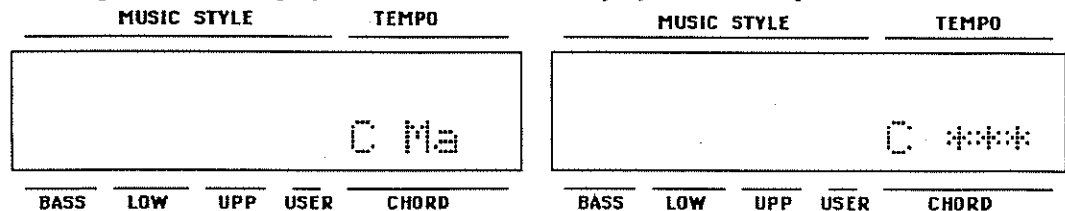

● To turn the Chord Intelligence function off, press **CHORD INTELLIGENCE** again and check the indicator goes out.

(9) Melody Intelligence

The Melody Intelligence function adds harmony to the melody you play. This function is effective in the Split mode. Play melody on the Upper Part while playing the chord in the Lower Part (this applies to the Chord Hold mode).

① Press **MELODY INTELLIGENCE** in ARRANGER and make sure that the indicator lights up.

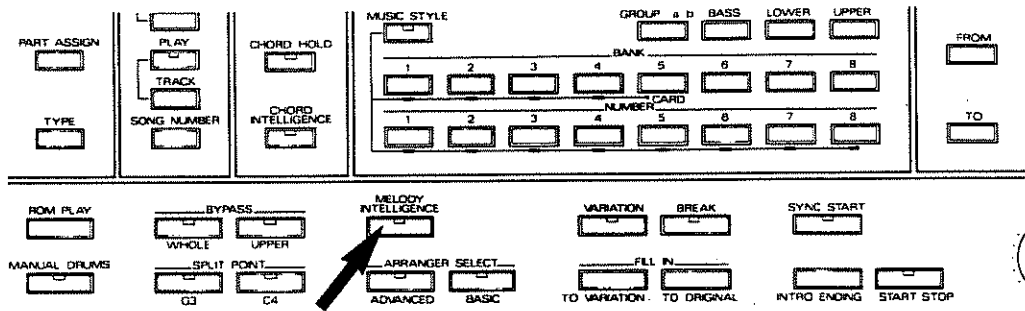

● To turn the Melody Intelligence function off, press **MELODY INTELLIGENCE** again and check the indicator goes out.

Now, you let's play the following song.

■ Étude (Example music sheet)

♩=120 RHYTHM (MUSIC STYLE)=42 BOSSANOVA
 (ARRANGER=BASIC/CHORD INTELLIGENCE=ON/VARIATION=OFF) UPPER=35 TROMBONE 1

1.

G7
17/49
18/50
CMa
19

TO ORIGINAL
C7
20
VARIATION
FMa
21
22

Emi7
23
A7
24
Dmi7
25

G7
26
CMa
27
C7
28

FMa
29
30
Emi7
31

A7
32
Dmi7
33
G7
34

2.

CMa
35
TO ORIGINAL
36
CMa
51
ENDING
52

4

INTERMEDIATE PROCEDURE

LET'S MASTER HOW TO ENJOY MUSIC MORE.

1

Adjusting the volume balance of each Part

The MASTER VOLUME knob controls the overall volume of the RA-50, so it cannot make fine adjustment of each Part. If you need volume adjustment for each Part, do as follows.

* The volume balance of each Part is set as follows at power up.

<Default Volume Setting Table>

Upper Part	100
Lower Part	80
Accompaniment Part	75
Bass Part	90
Drums Part	90

(1) Volume balance for the Upper and Lower Parts

a. Upper Balance

① Press or of UPPER in BALANCE section.

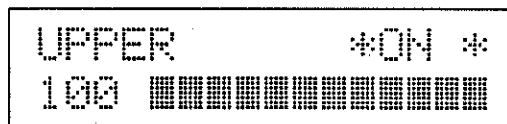
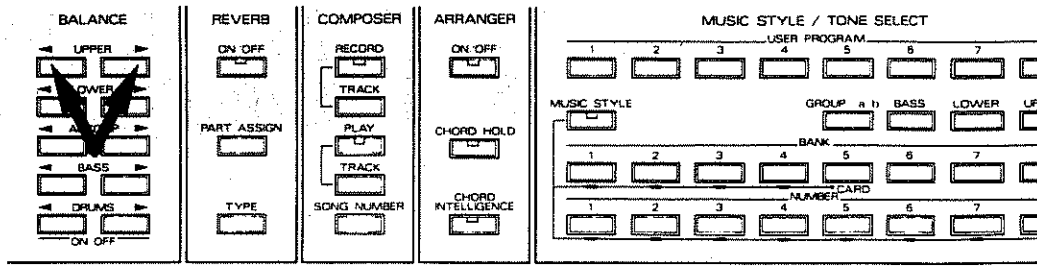

② To increase the volume, press . To decrease, press .

● To change the volume continuously, keep pressing or .

● By pressing and at the same time, you can turn to the muting state without changing the volume balance of the Upper Tone. (To cancel the muting state, press and simultaneously again.)

b. Lower Balance

① Press ◀ or ▶ of LOWER in BALANCE section.

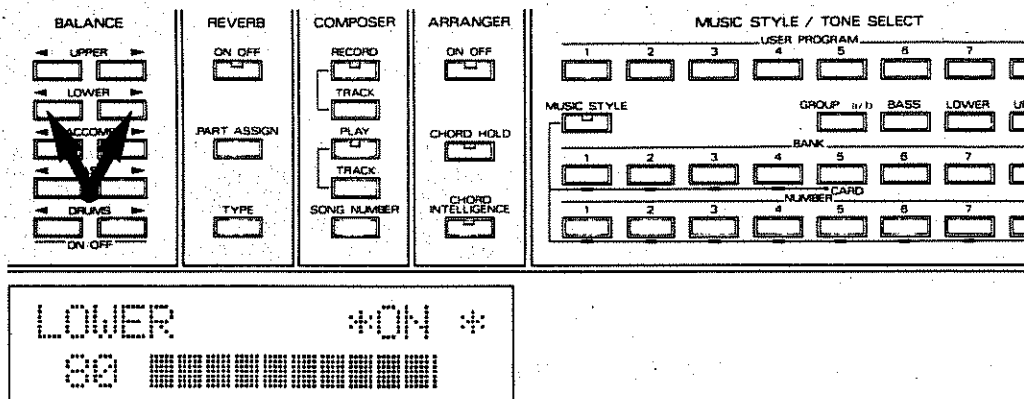

● The volume balance of the Lower Part can be set using the same procedure as the Upper Part. (Continuous volume change, mute and mute cancel can also be achieved in the similar method as the Upper Part.)

(2) Volume Balance for the other Parts

a. Accompaniment Balance

① Press ◀ or ▶ of ACCOMP in BALANCE section.

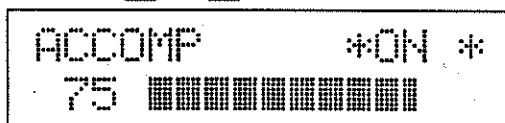

● The volume balance of the accompaniment can be set using the same procedure as the Upper Tone. (Continuous volume change, mute and mute cancel can also be achieved in the similar method as the Upper Tone.)

b. Bass Balance

① Press ◀ or ▶ of BASS in BALANCE section.

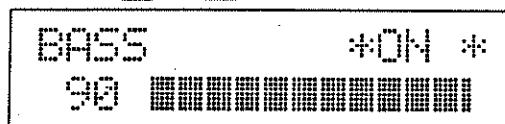

● The volume balance of the Bass can be set using the same procedure as the Upper Tone. (Continuous volume change, mute and mute cancel can also be achieved in the similar method as the Upper Tone.)

c. Drums Balance

① Press ◀ or ▶ of DRUMS in BALANCE section.

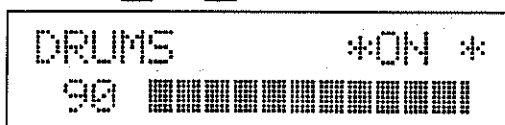

● The volume balance of the Drums can be set using the same procedure as the Upper Tone. (Continuous volume change, mute and mute cancel can also be achieved in the similar method as the Upper Tone.)

* The panning of the drum sounds (in stereo) is fixed. (For detailed explanation, read page 67 "(4) Manual Drums" in chapter 4.)

2

Creating spacious sounds

(1) About Reverberation

Reverb stands for reverberation. Reverberation gives depth to the sound and makes you feel the spaciousness of the room. In other words, reverb effect creates ambience as if you were playing in a concert hall. The RA-50 includes the reverb unit which can be turned on or off for each Part or for the entire Parts.

(2) On/Off of the Reverb Effect

a. On/Off for all the Parts

- ① Press **ON/OFF** of REVERB and make sure the indicator lights up.

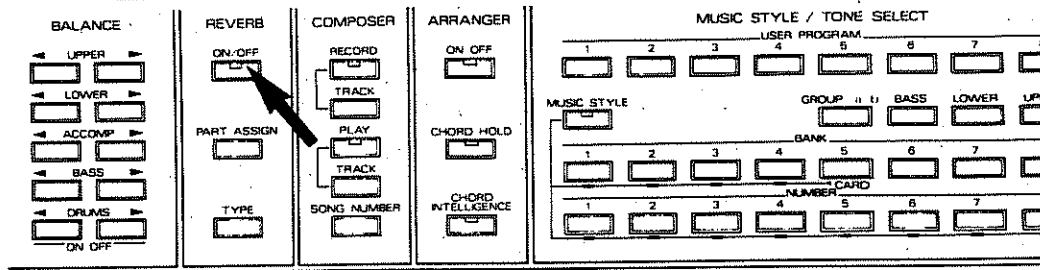

- To turn the reverb off, press **ON/OFF** again and check that the indicator goes out.

b. On/Off for Individual Part

Normally, all the Parts take on reverb effect when it is turned on. However, it is possible to turn on or off the reverb effect separately for Upper/Lower/Drums Parts.

- ① Press **PART ASSIGN** of REVERB.

(To turn on or off the Part currently shown in the display, take the following procedure without releasing **PART ASSIGN**.)

```
UPPER Part
Reverb      *YES*
```

UPPER part
Reverb * NO*

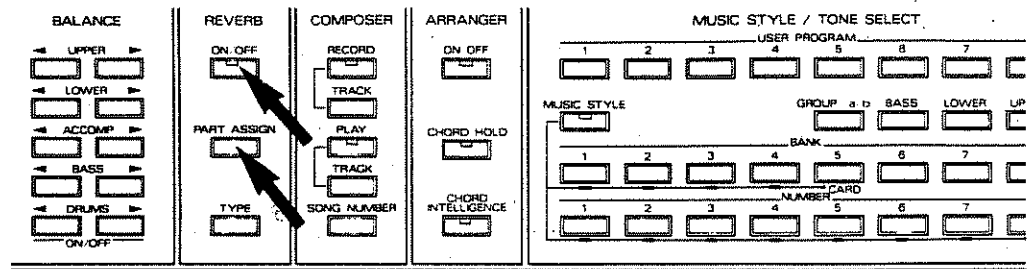

- ② While still holding **PART ASSIGN** down, press **ON/OFF**. (To turn on the reverb, make the display show *** YES ***, and to turn it off, make the display shown *** NO ***.)

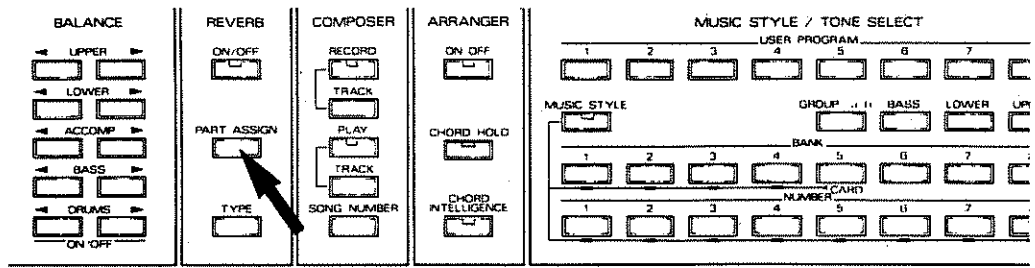

- ③ To continue to turn on or off the other Part, press **PART ASSIGN** until the desired Part appears, then take step ②.

* The Part display changes in sequence of UPPER - LOWER - DRUMS - UPPER.

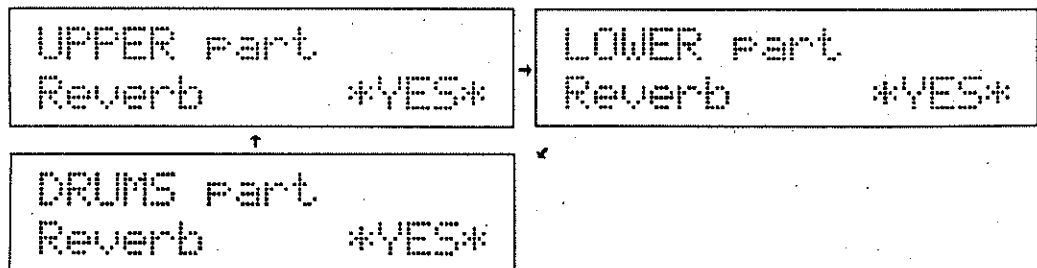

* When the reverb is set to off in all Parts, no reverb effect is obtained even by turning the overall reverb on.

(3) Changing Reverb Types

Any of the following 8 reverb types can be used.

<Reverb Type List>

Room 1	Reverberation in a small room.
Room 2	Reverberation in a large room.
Hall 1	Reverberation in a small hall.
Hall 2	Reverberation in a large hall.
Plate 1	Metallic reverberation.
Plate 2	Deeper reverberation than Plate 1.
Delay 1	Echo sound.
Delay 2	Longer echo than Delay 1.

① Press **TYPE**.

The image shows a screenshot of the RA-50 control panel. At the top, a display window shows "REVERB type" and "2 = Room 2". Below the display, the control panel is divided into several sections. The "PART ASSIGN" section has a "TYPE" button highlighted with a black arrow. Other sections include "ACCOMP", "BASS", "DRUMS", "ON/OFF", "PLAY", "TRACK", "SONG NUMBER", "CHORD HOLD", "CHORD INTELLIGENCE", "MUSIC STYLE", "GROUP", "BANK", "NUMBER", "CARD", "MASTER VOLUME", "ROM PLAY", "MANUAL DRUMS", "BYPASS", "WHOLE", "UPPER", "SPLIT POINT", "G3", "C4", "MELODY INTELLIGENCE", "ARRANGER SELECT", "ADVANCED", "BASIC", "VARIATION", "BREAK", "SYNC STA", "FILL IN", "TO VARIATION", "TO ORIGINAL", and "INTRO END".

② Keep pressing **TYPE** until the desired reverb type appears.

* The RA-50 is default to reverb type "2=Room 2".

3

User Program

The RA-50 allows you to store up to 8 different patches you program using various parameters and recall any of them just by a flick of switch. These 8 patches are called User Programs.

The following 25 parameters can be used for making a User Program.

- Upper Tone**.....Tone of the Upper Part.
- Lower Tone**.....Tone of the Lower Part.
- Bass Tone**.....Tone of the Bass Part.
- Upper Volume**.....Volume of the Upper Part.
- Lower Volume**.....Volume of the Lower Part.
- Accompaniment Volume**.....Volume of the Accompaniment Part.
- Bass Volume**.....Volume of the Bass Part.
- Drums Volume**.....Volume of the Drums Part.
- Split (OFF/G3/C4)**Whether to split the keyboard into two parts, Upper and Lower.
If so, at which key.
- Music Style**.....Pattern for accompaniment.
- Basic Tempo**.....Base tempo.
- Variation (ON/OFF)**Whether to play Variation performance or not.
- Arranger (ON/OFF)**Whether to use the Arranger function or not.
- Arranger Select (Basic/Advanced)**Arranger type to be used for the Arranger function.
- Chord Hold (ON/OFF)** Whether to hold the chord played on the Lower Part or not.
- Sync Start (ON/OFF)**Whether to use the Sync Start function or not.
- Chord Intelligence (ON/OFF)**Whether to use the Chord Intelligence function or not.
- Melody Intelligence (ON/OFF)**Whether to use the Melody Intelligence function or not.
- Reverb (ON/OFF)**Whether to turn on or off the reverb effect.
- Reverb Type**.....Selecting one of the 8 Reverb Types.
- Manual Drums**.....Whether to play the Drums Part from the keyboard.
- Pedal Switch 1**.....Assigning a function to the Pedal Switch 1.
- Pedal Switch 2**.....Assigning a function to the Pedal Switch 2.
- Pedal Switch 3**.....Assigning a function to the Pedal Switch 3.
- Pitch Bend Range**.....The maximum pitch change caused by using the pitch bender.

(1) Calling a User Program

It takes a lot of time to make a patch each time you play a song. To save time and work, you can record patches (User Programs) and recall one of them at any time you want. Up to 8 different User Programs can be recorded in the internal memory of the RA-50 or onto a memory card (optional M-256E). The following User Programs are preprogrammed from the manufacturer.

●User Program 1

Upper Tone.....31 SYN BRASS 1
Lower Tone.....11 ELEC PIANO 1
Bass Tone.....71 ACOU BASS 1
Split.....C4
Rhythm.....15 FUNK 1
Tempo.....110
Variation.....OFF Arranger.....ON
Arranger Select.....Advanced
Chord Hold.....OFF
Sync Start.....OFF
Chord Intelligence.....OFF
Melody Intelligence.....OFF
Reverb.....ON
Reverb Type.....Hall 1
Manual Drums.....OFF
Pedal Switch Assign.....1. Start/Stop
2. Fill in to Original
3. Fill in to Variation

●User Program 3

Upper Tone.....85 MARIMBA
Lower Tone.....16 CLAVI 1
Bass Tone.....73 ELEC BASS 1
Split.....C4
Rhythm.....25 REGGAE
Tempo.....140
Variation.....OFF Arranger.....ON
Arranger Select.....Advanced
Chord Hold.....OFF
Sync Start.....OFF
Chord Intelligence.....OFF
Melody Intelligence.....OFF
Reverb.....ON
Reverb Type.....Hall 1
Manual Drums.....OFF
Pedal Switch Assign.....1. Start/Stop
2. Fill in to Original
3. Fill in to Variation

●User Program 2

Upper Tone.....57 DOCTOR SOLO
Lower Tone.....52 ATMOSPHERE
Bass Tone.....72 ACOU BASS 2
Split.....C4
Rhythm.....17 BALLAD
Tempo.....120
Variation.....OFF Arranger.....ON
Arranger Select.....Advanced
Chord Hold.....OFF
Sync Start.....OFF
Chord Intelligence.....OFF
Melody Intelligence.....OFF
Reverb.....ON
Reverb Type.....Hall 1
Manual Drums.....OFF
Pedal Switch Assign.....1. Start/Stop
2. Fill in to Original
3. Fill in to Variation

●User Program 4

Upper Tone.....64 ELEC GUITAR 2
Lower Tone.....21 ELEC ORGAN 1
Bass Tone.....73 ELEC BASS 1
Split.....C4
Rhythm.....27 ROCK'N'ROLL
Tempo.....172
Variation.....OFF Arranger.....ON
Arranger Select.....Advanced
Chord Hold.....OFF
Sync Start.....OFF
Chord Intelligence.....OFF
Melody Intelligence.....OFF
Reverb.....ON
Reverb Type.....Delay 1
Manual Drums.....OFF
Pedal Switch Assign.....1. Start/Stop
2. Fill in to Original
3. Fill in to Variation

To call a prerecorded User Program, do as follows.

① Select a User Program you like using the 1~8 USER PROGRAM button.

* To call a different User Program, press the relevant button.

* To cancel the User Program mode, press the USER PROGRAM button that corresponds to the User Program number currently shown in the display. (This will return the RA-50 to the previous condition.)

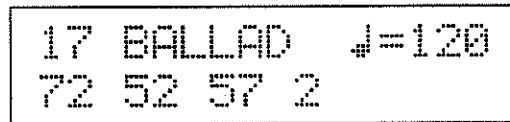

(2) Recording a User Program

The patch you have made on the panel switches can be recorded as a User Program. Up to 8 different User Programs can be recorded and they are retained safely even after the unit is switched off. Recording a new User Program will erase the previous data, so if you wish to retain the previous data, save it onto an optional memory card (M-256E) before writing a new program. (How to use a memory card is explained on page 61 "Using Memory Cards".)

* You can restore the User Programs preprogrammed from the manufacturer at any time.

① Make a patch using the 25 parameters.

② Press **WRITE**.

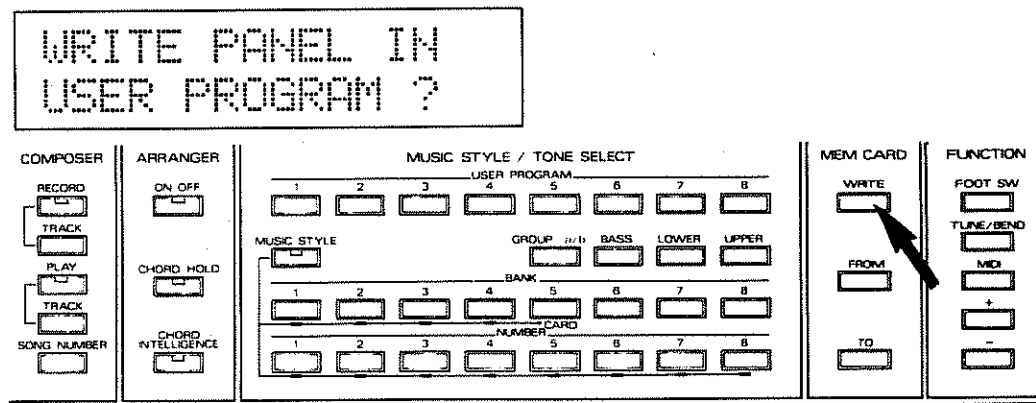

③ While still holding **WRITE** down, press the **USER PROGRAM** button where you wish to write the patch.

Writing a new User Program will automatically erase the previous data, but you can restore the User Programs preset from the manufacturer as shown below. However, restoring the preprogrammed User Programs will erase any data you have written in the RA-50 and the Song Composer function. Therefore, if you wish to retain the data, save it onto an optional memory card. (Song Composer function is explained in the next section "Song Composer".)

① Switch the RA-50 off.

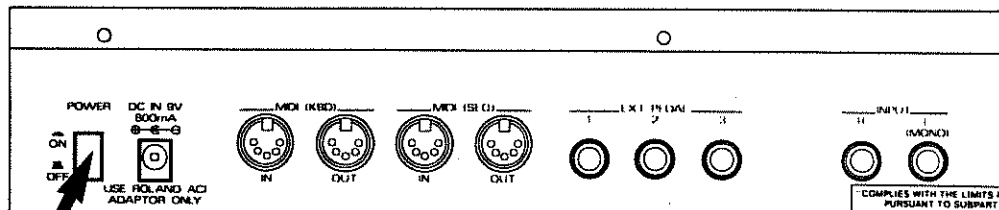

② Switch the RA-50 on while holding **WRITE** down.

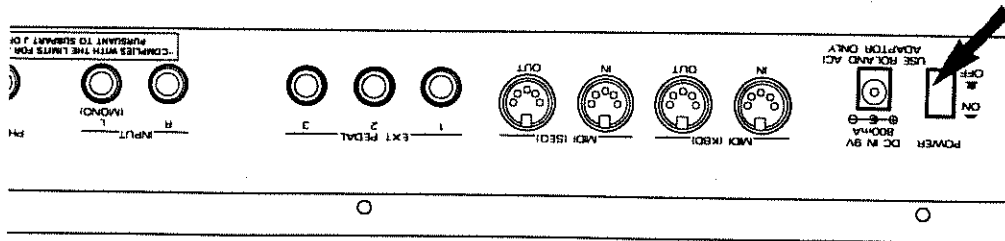
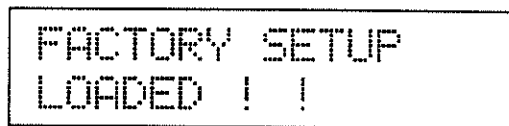

MEMORY CARD

WING	41 BAROQUE
42 BOSSANOVA	
43 RHUMBA	
44 CHA-CHA	
45 SALSA	
46 TANGO	
47 SAMBA	
48 FUSION	

MUSIC STYLE TEMPO

BASS LOW UPPER USER CHORD

Roland RA-50 REALTIME ARRANGER

BEAT MIDI MESSAGE

COMPOSER

RECORD

TRACK

PLAY

TRACK

SONG NUMBER

ARRANGER

ON OFF

CHORD HOLD

CHORD INTELLIGENCE

MUSIC STYLE / TONE SELECT

USER PROGRAM

1	2	3	4	5	6	7	8
---	---	---	---	---	---	---	---

MUSIC STYLE GROUP BASS LOWER UPPER

1	2	3	4	5	6	7	8
---	---	---	---	---	---	---	---

CARD NUMBER

1	2	3	4	5	6	7	8
---	---	---	---	---	---	---	---

MEM CARD

WRITE

FROM

TO

FUNCTION

FOOT SW

TUNE/BEND

MIDI

+

-

4

Song Composer (Recording the performance data)

The RA-50's Composer function allows you to record the music you play on the RA-50. The recording basic of the RA-50 is conceptual like a tape recorder in that it records sound. However, the recording process is very different since the RA-50 converts audio signal into digital and records it into computer memory. The major advantage of this method is that noise is shut out in recording, and pitch is not affected by changing the tempo in playback. The RA-50's Composer can record up to 3 songs. Each song can be played back individually. Also, each song consists of the Upper and Lower tracks, recording the Upper Part performance into the Upper track and the Lower Part performance into the Lower track (including the Style Performance) respectively.

(1) Recording a performance 1 - - Recording

There are two methods for recording a song.

Recording the Upper and Lower performance at the same time.

Recording the Upper and Lower performance separately (Monitor Recording).
(Details about Monitor Recording is explained the following "(4) Recording a performance 2".)

- ① Make sure that the Music Style is stopped and make the necessary settings for Style Performance.
- ② Press **SONG NUMBER** of COMPOSER to select a song number (destination song).

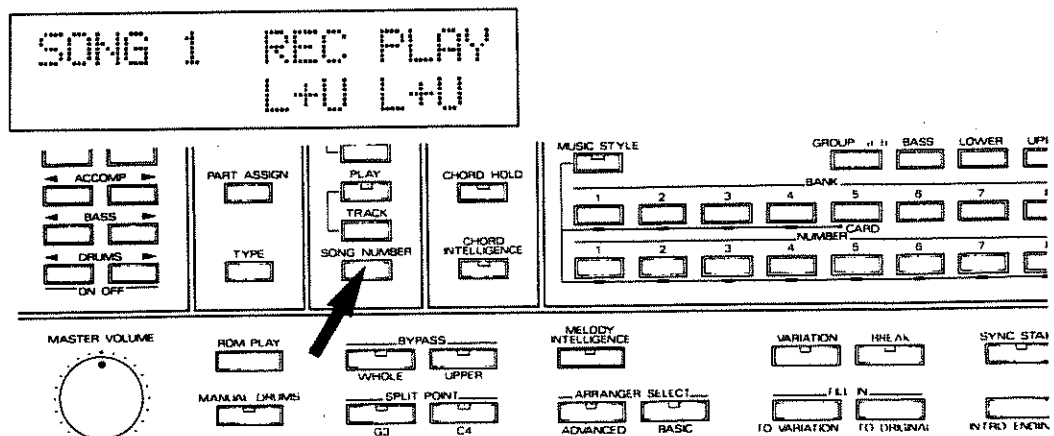

* Each time you press **SONG NUMBER**, the display changes as "1 - 2 - 3 - 1".

- ③ Press **TRACK** under **RECORD** to select the track (Upper or Lower) to be recorded. Keep pressing **TRACK** until "L + U" appears.

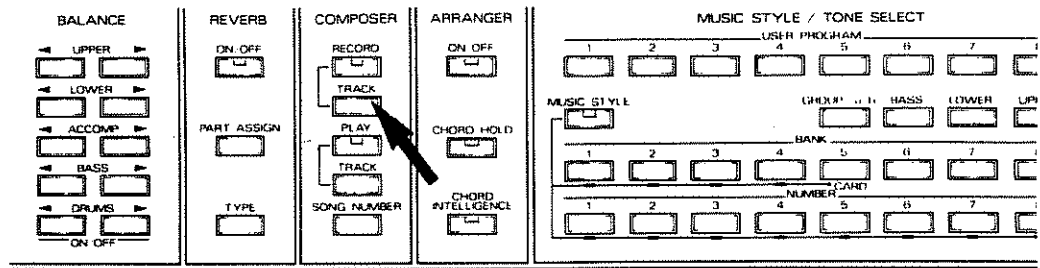

* "L" represents Lower and "U" represents Upper track. The display changes as "L - U - L+U - L.....".

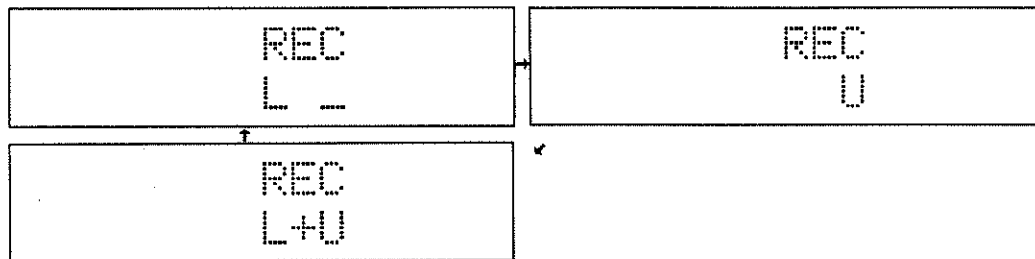

- ④ Press **RECORD** and make sure the indicator lights up. (Pressing **RECORD** will automatically select Split C4.)

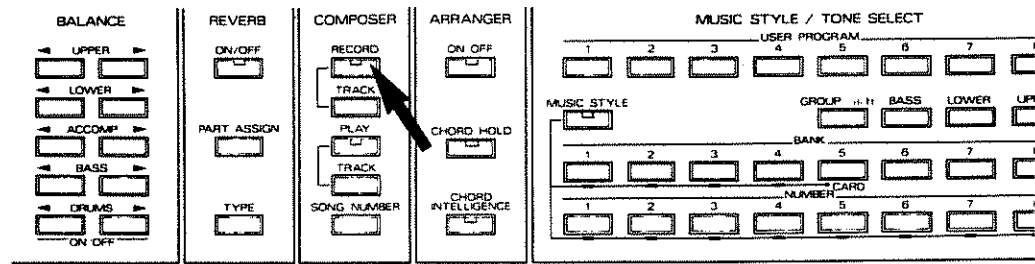

* To cancel recording, press **RECORD** again and make sure the indicator goes out.

- ⑤ Play the keyboard to start recording. (There are 4 different types for starting recording. For details, read page 32 "(4) Starting the Music Style" in chapter 3.)

- ⑥ When you finish playing, stop recording. (There are 2 types for stopping recording. For details, read page 33 "(5) Stopping the Music Style" in chapter 3.)

* If you make a mistake, stop recording by pressing **START/STOP** then resume from step 3.

* The Lower track can store up to 96 time Chord Changes for each song.

- * The shortest timing value recorded in the Upper track is 64th note triplets.
- * The performance data recorded with the Composer function is retained in memory even after the unit is switched off.
- * To store more than three songs, save the existing songs onto an optional memory card, then record the other songs. If you record a new song with three songs already stored in memory, the previous song will be erased. (For details of memory card, see page 61 "5 Using Memory Card" in chapter 4.)
- * When the remaining memory for recording is very small (less than 10 %), the RECORD indicator flashes. When no memory is left, recording stops automatically.
- * Recording with Pitch Bend/Modulation/Tempo Change/Volume control of each Part will consume large amount of memory.

The following are data which can be recorded:

< Lower Track >

Lower Tone
 Bass Tone
 Lower Volume
 Accompaniment Volume
 Bass Volume
 Drums Volume
 Music Style
 Tempo (Tempo Change)
 Variation (ON/OFF)
 Arranger (ON/OFF)
 Arranger Select (Original/Advanced)
 Chord Hold (ON/OFF)
 Chord Intelligence (ON/OFF)
 Reverb (The entire or individual Parts ON/OFF)
 Reverb Type
 Manual Drums (ON/OFF)

< Upper Track >

Upper Tone
 Upper Volume
 Melody Intelligence (ON/OFF)
 Pitch Bend
 Modulation (vibrato)

(2) Playing the performance data 1 - - Playback

There are two methods for playing back the recorded performance data; playing both the Upper and Lower Tracks at the same time and playing each track individually.

- ① Press **TRACK** under **PLAY** of **COMPOSER** to select the track to be played back.

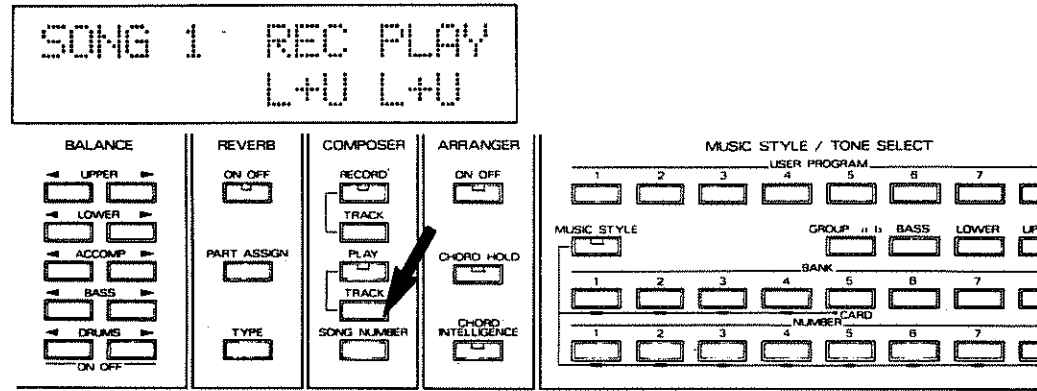

*Each time you press **TRACK**, the display changes as "L - U - L+U - L.....".

- ② Press **PLAY** to start playing. (The **PLAY** indicator lights up.)

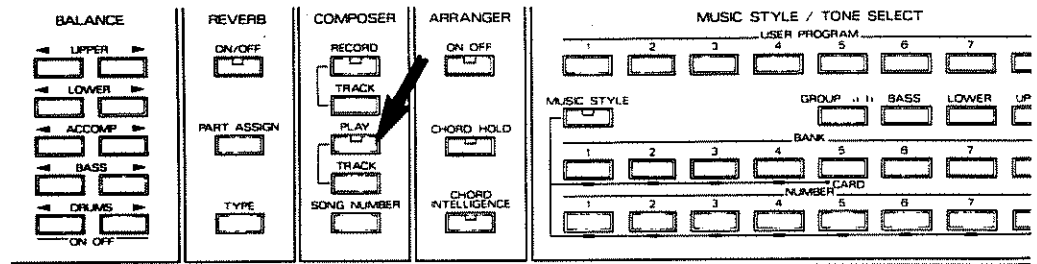

- Pressing **PLAY** again will flash the indicator. To stop playback, press **PLAY** once again. (To continue to playback data = repeat play, do not press **PLAY**). For details, read the following section "(3) Playing the performance data 2".)

- ③ Take either of the following procedures:

- Press **START/STOP**.

This will playback the recorded data faithfully.

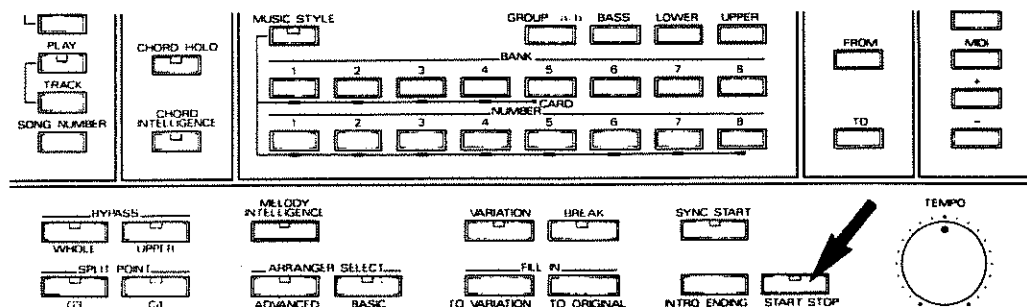

● Press **SYNC START**.

This will playback the recorded data faithfully by playing the Lower Part.

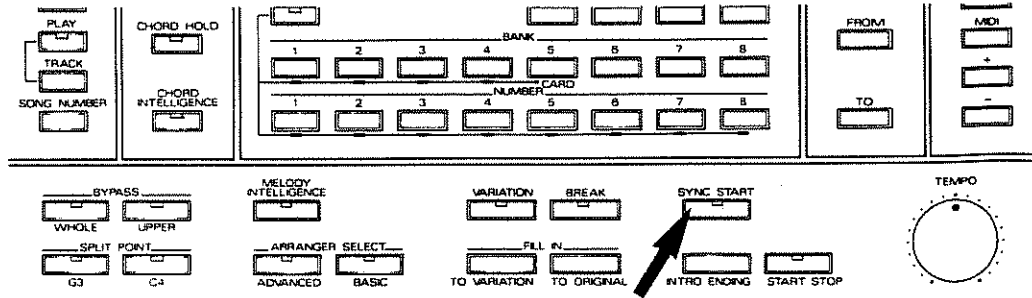

④ The RA-50 automatically stops after playing the final measure. (The PLAY indicator goes out.)

● To stop playback in the middle of the song, press **START/STOP** or **INTRO/ENDING**. **START/STOP** will stop playing immediately, while **INTRO/ENDING** will stop playing after the ending.

(3) Playing the performance data 2 - - Repeat

If the recorded performance data does not include any Intro or Ending, it can be played back repeatedly (Repeat Play). (Data with Intro or Ending will automatically stop after played back once even if you use the Repeat Play function.)

① Press **TRACK** under **PLAY** to select the track to be played.

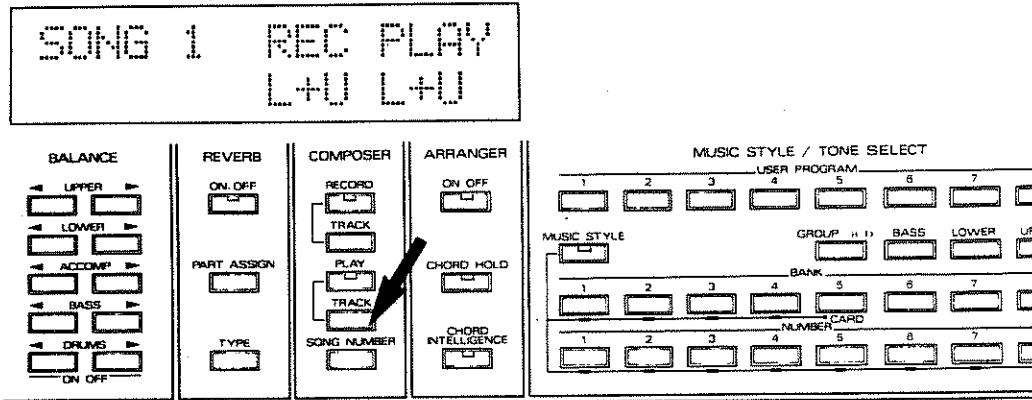

② Press **PLAY** twice and make sure that the indicator flashes.

③ Press **START/STOP** to start the Repeat Play.

* To stop playback press **START/STOP** or **INTRO/ENDING**.

* The Repeat Play function can be used not only for listening but also for practicing ad-lib to a specific chord, etc.

(4) Recording a performance 2 - - Monitor Recording

The Monitor recording allows you to record new data into a different track while playing (monitoring) data recorded in a track.

It may be better to record the Lower Part first since the Drums part is included in the Lower Part, therefore it will be easier to record melody later to the rhythm.

① Make sure that the Music Style is stopped, and make necessary setting for Style Performance.

② Press **SONG NUMBER** of **COMPOSER** to select a song number (destination song) to be recorded.

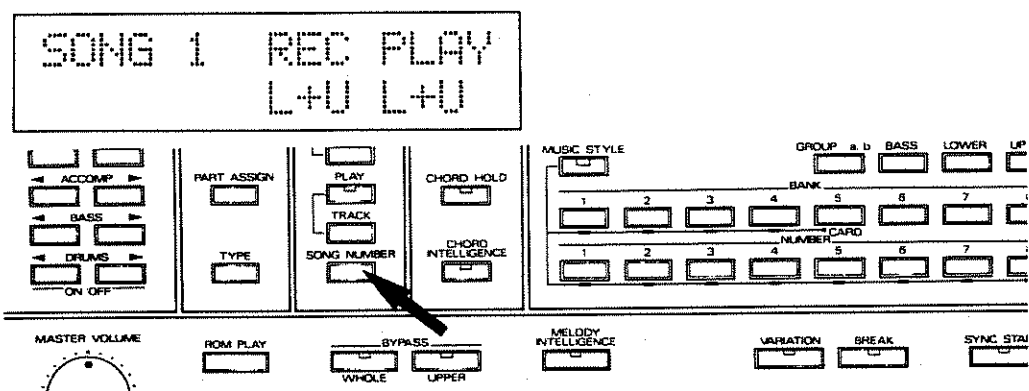

③ Press **TRACK** under **RECORD** to select the track (Upper or Lower) to be recorded.

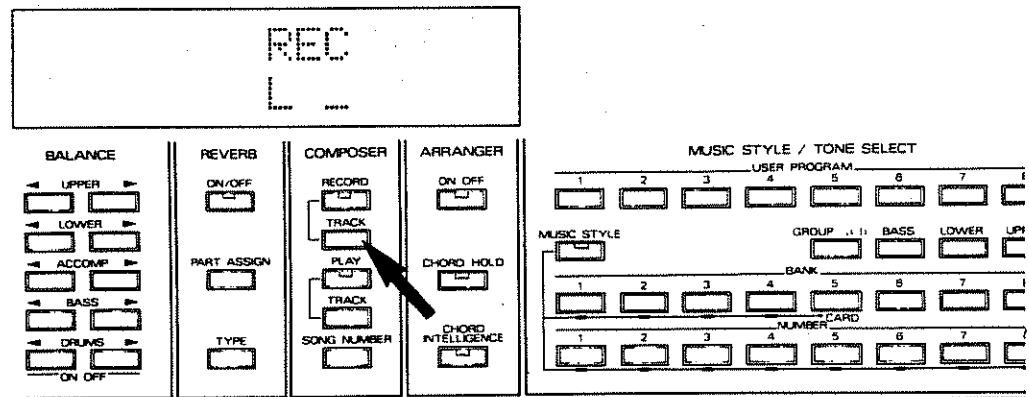

④ Press **RECORD** and make sure the indicator lights up. (Pressing **RECORD** will automatically select Split C4.)

* To cancel recording, press **RECORD** again and make sure the indicator goes out.

⑤ Play the keyboard to start recording. (There are 4 different types for starting recording. For details, read page 32 "(4) Starting the Music Style" in chapter 3.)

⑥ When you finish playing, stop recording. (There are 2 types for stopping recording. For details, read page 33 "(5) Stopping the Music Style" in chapter 3.)

● If you make a mistake, stop recording by pressing **START/STOP** then resume from step ③.

⑦ Press **TRACK** (under **PLAY**) to select the track to be monitored and press **TRACK** (under **RECORD**) to select a new track to be recorded.

• DISPLAY for recording Upper while monitoring Lower.

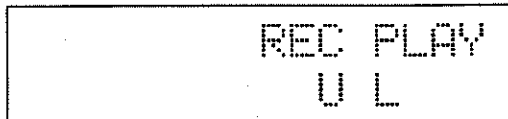

• DISPLAY for recording Lower while monitoring Upper.

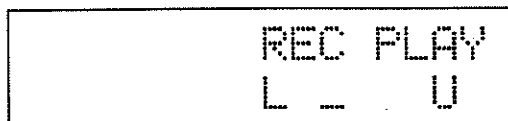

* If you try to record new data onto the track being monitored or select "L+U" mode, the Monitor Recording cannot be done.

⑧ Press **RECORD** and **PLAY** and make sure the indicators light up.

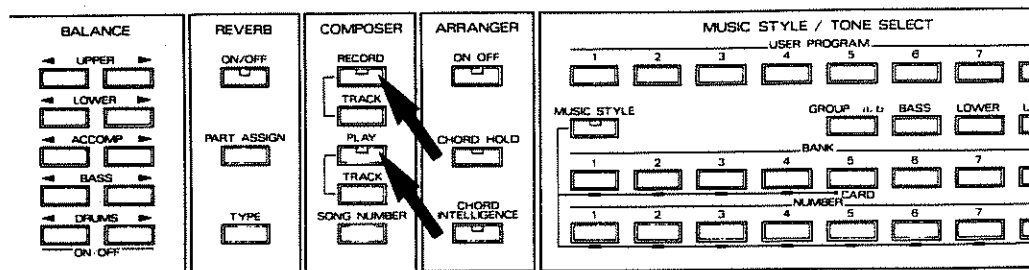

* If the PLAY indicator flashes, the Monitor Recording cannot be done. Press **PLAY** again and make sure the indicator lights up.

* You may press either of **RECORD** or **PLAY** prior to another.

⑨ Press **START/STOP** or **SYNC START** to start monitor recording.

⑩ When you finish playing song, press **START/STOP** to stop the monitor recording.

5

Using Memory Cards

(1) Useful Memory Cards

a. Data that can be saved on a memory card

The RA-50 allows you to save User Program data that are Music Style selections, Tone settings etc, and Song Composer data onto a memory card. You can use both a music style card and memory card. However, when you save Song Composer data/User Programs, be sure to use the specific memory card (optional : M-256E), since these cannot be saved onto a music style card.

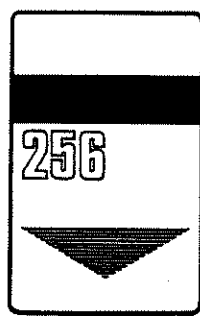

* M-256D can be used the same as M-256E.

Song Composer and User Program data can be saved or loaded together or separately.

- SONG COMPOSER Song Composer data
- USER PROGRAMS User Program data
- SONGS/USER PROG. Song Composer/User Program data

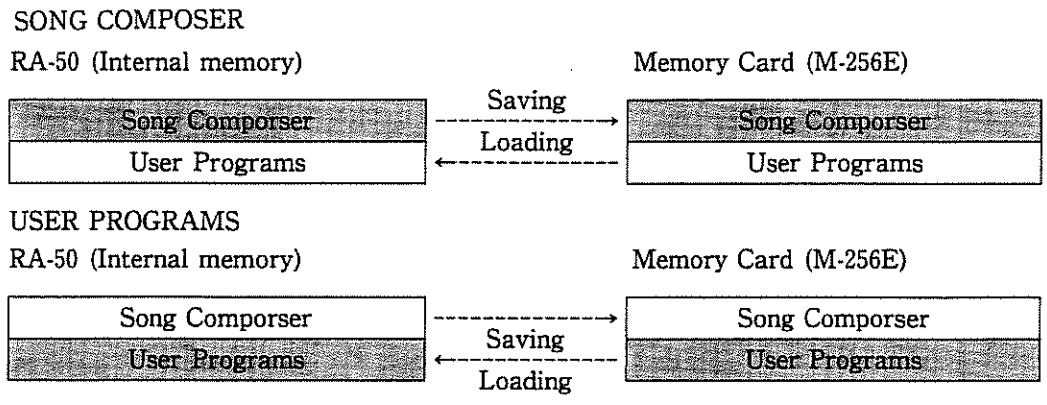

SONGS/USER PROG.
RA-50 (Internal memory)

Memory Card (M-256E)

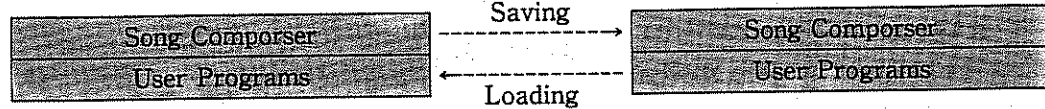

b. Memory Protect

A memory card has a Memory Protect switch to prevent accidental erasure of data. When you save Song Composer and User Program data in the RA-50 onto a memory card, set the Memory Protect switch to the OFF position. When you have saved data, make sure to set it back to the ON position.

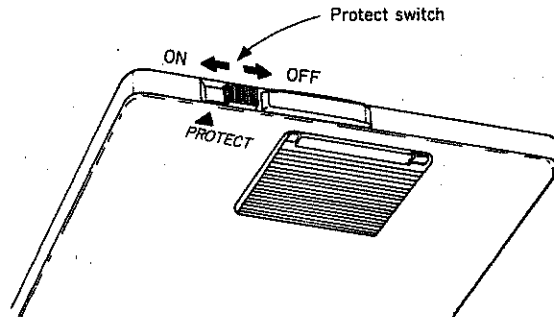

(2) Saving onto a memory card

- ① Insert a memory card into the card slot. (Be sure that the side with the letter "ROLAND" facing upward and inserting in the correct direction that an arrow indicates.)

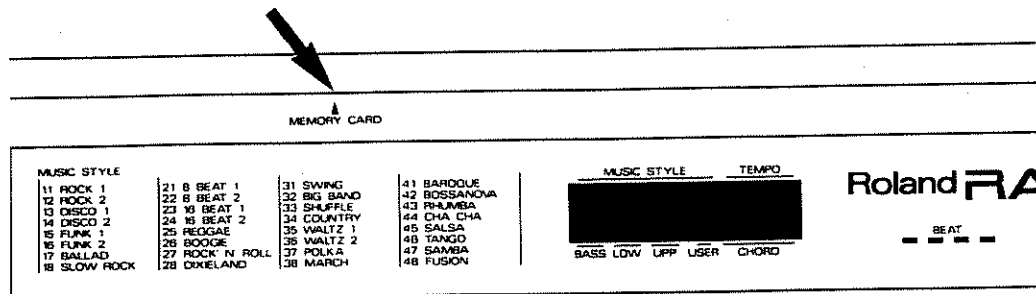

- ② Set the Protect Switch on the memory card to the OFF position.

- ③ Press **TO** of CARD.

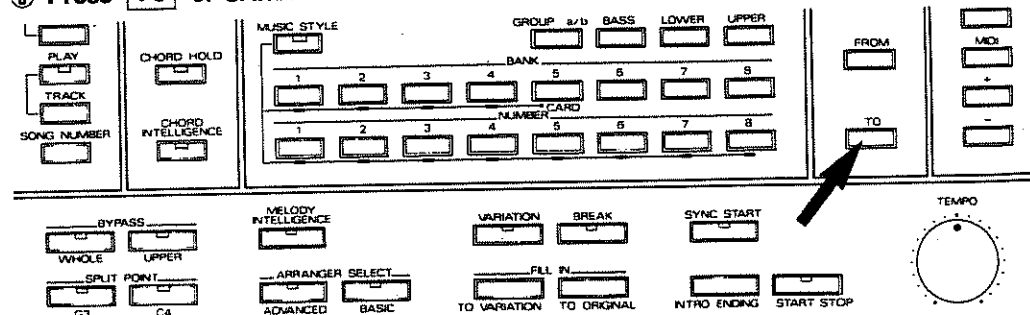

- DISPLAY of saving User Program data

```

USER PROGRAMS
TO MEMORY CARD

```

- DISPLAY of saving Song data

```

SONG COMPOSER
TO MEMORY CARD

```

- DISPLAY of saving Song and User Program data

```

SONGS/USER PROG.
TO MEMORY CARD

```

- ④ Press **WRITE** while holding **TO** down.

- If you use a brand new memory card, the display responds as shown below. If so, repeat step ④.

```

ILLEGAL CARD !!
WRITE AGAIN ?

```

- * When you are using a card which has been used before, data will be saved after step ④. However, be sure that any previous data on the card will be replaced with the new data.

- ⑤ When data saving is completed, the display responds as shown below.

```

      OK !!
SAVE COMPLETE

```

- * Saving data onto a card does not affect data in the RA-50.

- * If the display does not respond with "OK!!...", refer to page 84 "Error Messages".

- ⑥ Set the Protect Switch on the card back to the ON position, then remove the card.

- * It may be a good idea to put down the name of the data on the label of the card.

(3) Loading data from a memory card back to the internal memory

To load data saved on a memory card back to the internal memory of the RA-50, do as follows.

- ① Insert the memory card into the card slot. (Be sure that the side with the letter "ROLAND" facing upward and inserting in the correct direction that an arrow indicates.)

- ② Press **FROM** of CARD.

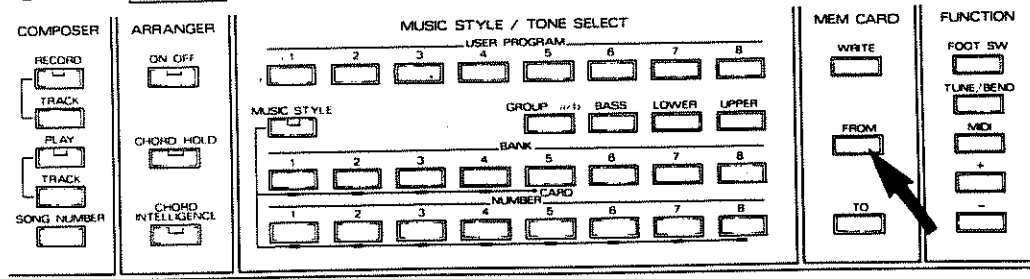

- DISPLAY of loading User Program data

```

USER PROGRAMS
FROM MEMORY CARD
  
```

- DISPLAY of loading Song data

```

SONG COMPOSER
FROM MEMORY CARD
  
```

- DISPLAY of loading Songs and User Program data

```

SONGS/USER PROG.
FROM MEMORY CARD
  
```

- ③ Press **WRITE** while holding **FROM** down.

```

OK !!
LOAD COMPLETE
  
```

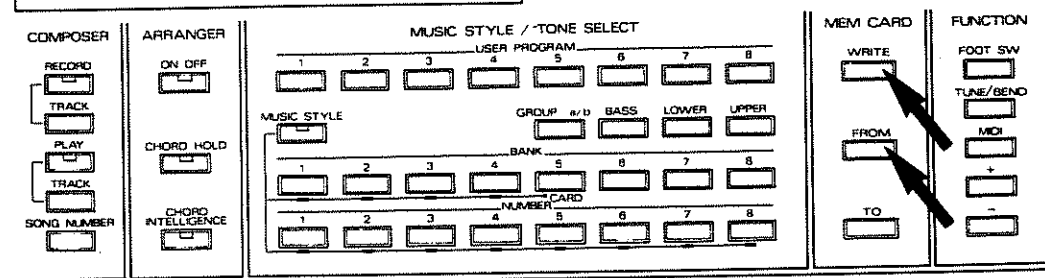

- ④ Release the buttons, then remove the card.

* When you load data into the RA-50, leave the Protect Switch on the memory card ON.
When you are not using a memory card, be sure to keep the Protect Switch ON.

6

Advanced procedure for playing

(1) Tuning the RA-50

The RA-50 can be tuned to the connected keyboard. Adjust it with the Master Tune in the Sound Module. The variable range of the pitch is from 427.5 to 452.6Hz.

The Master Tune you have set will retain even after the unit is switched off.

- ① Press **TUNE/BEND**.

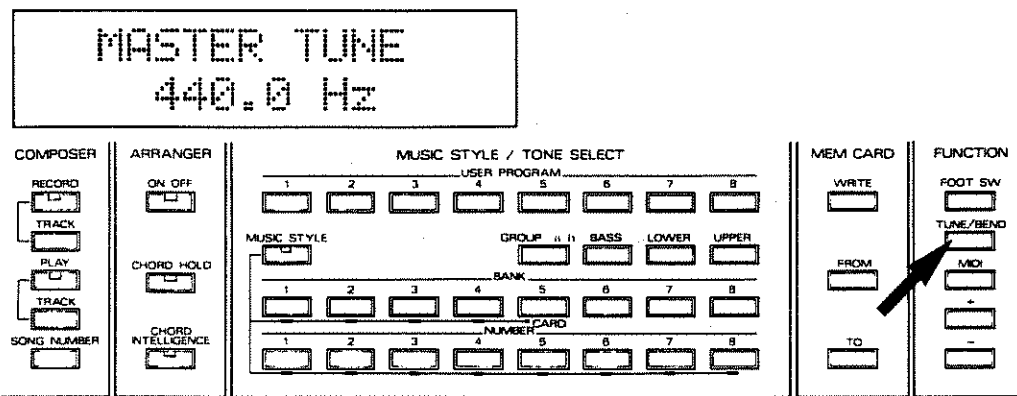

- If the display does not respond as shown above, press **TUNE/BEND** until the proper Master Tuning display appears.

- ② To increase the pitch, press **+**. To decrease, press **-**.

(2) Setting the Pitch Bend Range

The Upper Part of the RA-50 can receive bender messages sent from the connected keyboard. The variable range of the pitch is determined by the Pitch Bend Range value. (The RA-50 is default to Pitch Bend Range 2.)

Select a Pitch Bend Range value from the following 8.

- 1.....1 half tone (minor 2nd)
- 2.....2 half tones (major 2nd)
- 3.....3 half tones (minor 3rd)
- 4.....4 half tones (major 3rd)
- 5.....5 half tones (perfect 4th)
- 6.....6 half tones (augmented 4th)
- 7.....7 half tones (perfect 5th)
- 12.....12 half tones (an octave)

① Press **TUNE/BEND**.

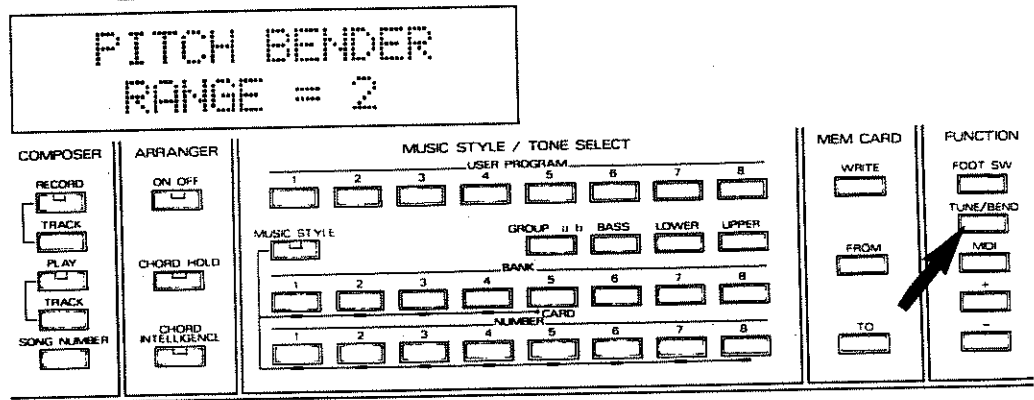

● If the display does not respond as shown above, press **TUNE/BEND** until the correct display appears.

② To increase the pitch bend range, press **+**. To decrease, press **-**.

(3) Using a Foot Switch

Up to three foot switches (DP-2, DP-6 or FS-5U) can be connected to the RA-50 at the same time for you to control with your foot. To each foot switch, a different function can be assigned from the panel switches.

Functions that can be assigned to the foot switches

Bypass ON/OFF (Bypass is OFF while holding down.

Bypass WHOLE is ON when the Foot Switch is released.)

Rhythm (Start ↔ Stop)

Fill in to Variation

Fill in to Original

Rhythm (ORIGINAL ↔ VARIATION)

Split ON/OFF (OFF ↔ Split C4)

Arranger Select (Basic ↔ Advanced)

Melody Intelligence (ON ↔ OFF)

- ① Press **FOOT SW** to call the foot switch setting display. (Pressing **FOOT SW** once will select foot switch function 1. To change to a different foot switch number, press **FOOT SW** again.)

Pedal 1
Start/Stop

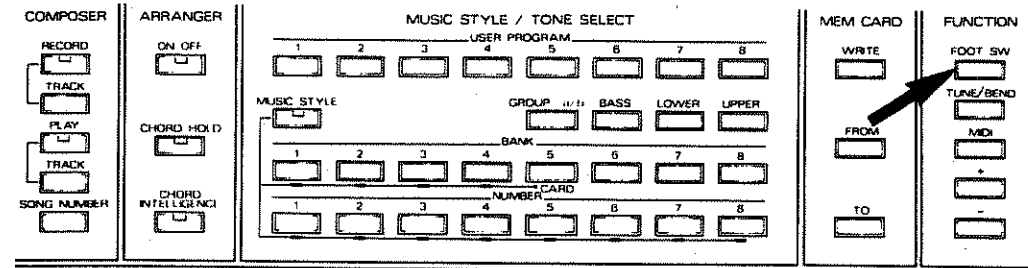

- ② Select the function to be assigned with **+** or **-**.

(4) Manual Drums

30 different drum voices can be created by playing the keyboard.

- ① Press **MANUAL DRUMS**. (The indicator lights up.)

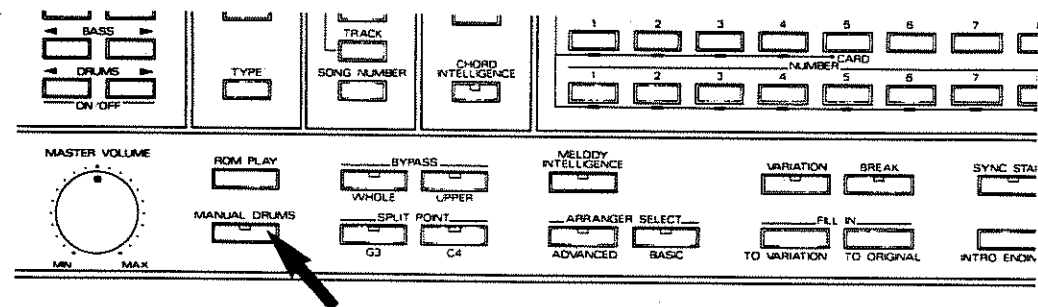

- ② Press keys on the keyboard.

* Drum voices are played whether the Rhythm is playing or stopped.

- To cancel the Manual Drums mode, simply press **MANUAL DRUMS** again. (The indicator goes out.)

* The Chord detecting function of the Arranger is effective even in the Manual Drums mode, therefore, it is possible to play the Manual Drums during Style Performance. However, a keyboard with less than 61 keys is too short for the Chord detecting. So, you must set the RA-50 so that bass/chord will keep playing with the Chord Hold function, then press **MANUAL DRUMS** to use the Manual Drums function.

* During Manual Drums playing, the arranger's chord cannot be changed. To change chords, cancel the Manual Drums mode once.

The sound positions (panning) of the RA-50's Drum voices are set as shown below. (When the Reverb is on, the sound positioning may be unclear.)

Note	Tone name	Pt 1 #	Left <<<<<<	Center	>>>>>> Right
B 1	Acoustic Bass Drum	1		●	
C 2	Acoustic Bass Drum	1		●	
C#2	Rim Shot	1		●	
D 2	Acoustic Snare Drum	1		●	
D#2	Hand Clap	1		●	
E 2	Electric Snare Drum	1		●	
F 2	Acoustic Low Tom	1	●		
F#2	Closed High Hat	1		●	
G 2	Acoustic Low Tom	1	●		
G#2	Open High Hat 2	2		●	
A 2	Acoustic Middle Tom	1		●	
A#2	Open High Hat 1	2		●	
B 2	Acoustic Middle Tom	1		●	
C 3	Acoustic High Tom	1			●
C#3	Crash Cymbal	2		●	
D 3	Acoustic High Tom	1			●
D#3	Ride Cymbal	1		●	
E 3					
F 3					
F#3	Tambourine	1		●	
G 3					
G#3	Cowbell	1		●	
A 3					
A#3					
B 3					
C 4	High Bongo	1			●
C#4	Low Bongo	1			●
D 4	Mute High Conga	1		●	
D#4	High Conga	1		●	
E 4	Low Conga	1	●		
[F 4	High Timbale	1		●	
F#4	Low Timbale	1			●
G 4	High Agogo	1			●
G#4	Low Agogo	1			●
A 4	Cabasa	1		●	
A#4	Maracas	1			●
B 4	Short Whistle	2		●	
C 5	Long Whistle	2		●	
C#5	Quijada	3		●	
D 5					
D#5	Claves	1	●		

(5) LCD Contrast

If the LCD display is not clearly viewed, adjust the contrast of the display with the LCD Contrast control. You can change the contrast in 8 levels. The contrast you have set will remain even after the unit is switched off.

- ① Press **TUNE/BEND** .

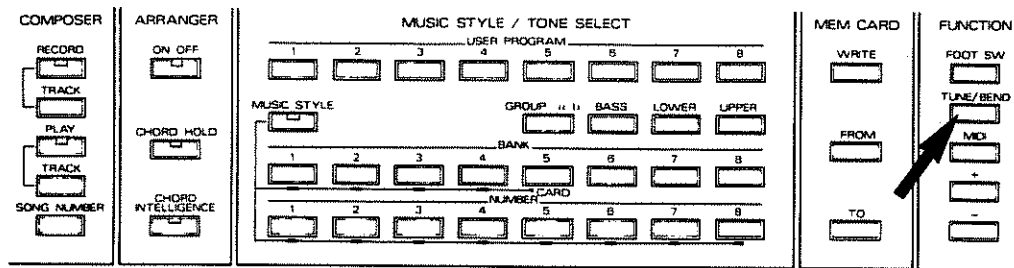
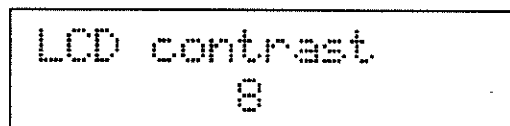

NOTE) LCD stands for "Liquid Crystal Display". Using in various devices such as a watch or calculator, since it requires small amount of power consumption and the display is stable.

- When the display does not respond as shown above, press **TUNE/BEND** until the correct display appears.

- ② To make the display darker, press **+** . To make it lighter, press **-** .

Now, try some functions explained so far using the example score.

■ Étude (Example music sheet)

$\text{♩} = 140$ $\text{♪} = \text{♪} \text{♪}$
RHYTHM (MUSIC STYLE) = 31 SWING
(ARRANGER = BASIC/CHORD INTELLIGENCE = ON/VARIATION = OFF) UPPER = 67 CLARINET

INTRO.
CMa

CMa FMa

CMa

C7 **TO VARIATION** FMa

FDim G7

C7

1 2 3 4

5 6 7

8 9 10

11 12 13 14

15 16 17

18 19 20

**FOR MORE INTEGRATED SYSTEM SETUP
WITH EXTERNAL DEVICES.**

5

**ADVANCED
PROCEDURE**

1

Setting the MIDI functions

The following explains the RA-50's MIDI functions.

(1) What is MIDI ?

MIDI stands for Musical Instrument Digital Interface that makes it possible to send and receive messages between different electronic musical instruments. By connecting the RA-50 with another musical instrument via MIDI, you can play the musical instrument from the RA-50 or control the RA-50 from the instrument. Since the RA-50 does not feature its own keyboard, you may connect an electronic piano or MIDI keyboard to the RA-50 via MIDI. There are many other instruments that can be connected to the RA-50 via MIDI.

(2) Devices that can be connected via MIDI

The following are the instruments which can be connected to the RA-50:

Electronic Piano (e.g. Roland Piano)

Synthesizer (e.g. D-10/20/50)

Sampler (e.g. S-50)

Keyboard Controller (e.g. A-50/80)

You may connect a keyboard instrument to enjoy the RA-50's excellent sounds and Style Performance. Also, it is possible to play the RA-50's Parts using the external instrument.

MIDI Sequencer (e.g. MC-500 MKII)

A MIDI sequencer records performance data in MIDI signals and plays the recorded data. It can be used just like a tape recorder. A MIDI sequencer may be effectively used for recording a long song that cannot be recorded into the RA-50's composer. Also, you may use it to record data and correct it later.

Rhythm Machine (e.g. R-8)

By using a rhythm machine with the RA-50, you can play the rhythm voices in the rhythm machine as well as those in the RA-50.

Effect Unit (e.g. DEP-5)

You may connect effect units to the RA-50 to add effects to the sounds.

(3) MIDI Sockets on the RA-50

The RA-50 features four MIDI sockets; MIDI (KBD) IN, MIDI (KBD) OUT, MIDI (SEQ) IN and MIDI (SEQ) OUT. Normally MIDI IN sockets receive signals from external MIDI devices and MIDI OUT sockets transmit signals to external devices. MIDI (KBD) IN and MIDI (SEQ) IN, MIDI (KBD) OUT and MIDI (SEQ) OUT, however, function in a slightly different way.

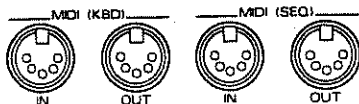

a. MIDI (KBD) IN/ MIDI (KBD) OUT

Connect an instrument that features a keyboard, such as an electronic piano, MIDI keyboard, etc. To play Style Performance on the RA-50, it is essential to connect an electronic piano or MIDI keyboard to this socket.

b. MIDI (SEQ) IN/ MIDI (SEQ) OUT

Connect a MIDI sequencer or rhythm machine to this socket. To sync the RA-50 to an external MIDI instrument, this socket is used.

* Sync Play: Sync is means that a slave unit plays to the master device in the tempo and start/stop timing of the master device.

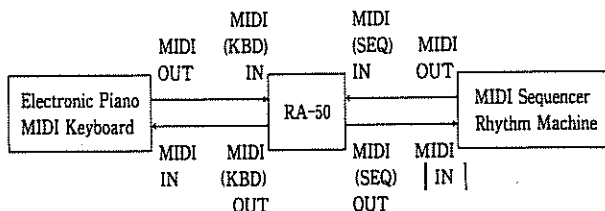

(4) Internal Structure of the RA-50

The normal Style Performance of the RA-50 allows you to play the Upper/Lower Parts from the keyboard of the connected instrument. The other Parts can also be controlled by the external MIDI keyboard. The following are the Parts built in the RA-50.

UPPER	Upper Part
LOWER	Lower Part
BASS	Bass Part
DRUMS	Drums Part
ACCOMP1	Accompaniment Part 1 ★
ACCOMP2	Accompaniment Part 2 ★
ACCOMP3	Accompaniment Part 3 ★
Rx. 1	Part 1 for receiving only
Rx. 2	Part 2 for receiving only

★Correspond to the accompaniments for the Style Performance.

DRUMS Part is specifically for drum voices played with the Manual Drums function. The other Parts can be played with various sounds and controlled via MIDI.

Receive Parts 1 and 2 are not used for performance on the RA-50 itself (when playing the Upper/Lower Parts from an electronic piano or the Style Performance), but can also be controlled via MIDI and played just like the other Parts.

Moreover, there are Arranger Parts which are provided for controlling the Arranger function or change Music Styles externally.

Arranger UPPER	Upper Part + Melody Intelligence
Arranger LOWER	Lower Part + Arranger, Chord Intelligence
CONTROL	Changing Music Styles

The above Parts can set MIDI channel, Part On/Off, Program Change On/Off and Control Change On/Off for receive (Rx), transmit (Tx) and extended transmit (Ex) individually.

(5) Difference between normal transmission and extended transmission

Normally, performance messages of each Part are transmitted through the MIDI (SEQ) OUT socket. Extended transmission transmits the performance messages of each Part through the MIDI (KBD) OUT when playing the Style Performance using the sound modules (e.g. external synthesizer) other than the RA-50's internal sound module.

(6) Local Control

Normally, a MIDI keyboard such as an electronic piano generates sound when the keyboard is played. This is because the keyboard and the internal sound module are connected (this is Local On condi-

tion). However, in some types of keyboards, the keyboard and the internal sound module can be disconnected (this is Local Off condition).

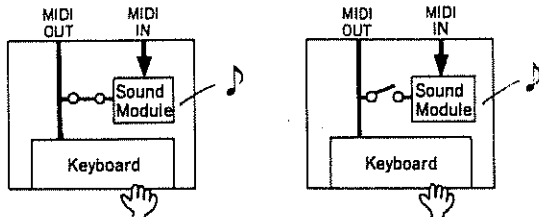

Sound is produced when the Keyboard is played.

No sound is produced when the Keyboard is played. (Sound is produced by performance messages received through MIDI IN)

When the unit is set to Local Off, performance messages from the keyboard are only output from the MIDI OUT, therefore, the internal sound module is controlled only by the messages received through the MIDI IN. When you use a MIDI keyboard with the RA-50, set the MIDI keyboard to Local Off. In this way, the sound of the MIDI keyboard and the RA-50 can be used separately or play the Split performance.

When using the MIDI keyboard on its own, turn the Bypass of the RA-50 on. In this way, the performance messages fed into the MIDI (KBD) IN are transmitted from the MIDI (KBD) OUT, playing the internal sound module from the keyboard of the MIDI keyboard.

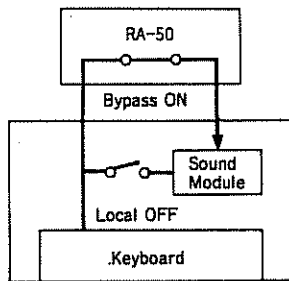

(7) Functions of the Panel Switches for MIDI

When MIDI functions are being edited (when **MIDI** is pressed), the panel switches function differently.

USER PROGRAM	Selects the MIDI function to be edited.
TO	Selects the Part to be set (to the next Part).
FROM	Selects the Part to be set (to the previous Part).
+	Changes values (increasing a number / ON).
-	Changes values (decreasing a number / OFF).
WRITE	Calls the Program Change map.
MUSIC STYLE	Finishes editing

*While a Music Style is being played, MIDI functions cannot be edited. (Pressing **MIDI** has no effect.)

When USER PROGRAM 1 ~ 4, 6 or 7 is selected, Parts (display) are changed as show below.

USER PROGRAM 1~4	USER PROGRAM 6	USER PROGRAM 7 (Ex. PROG MAP)
A-UPPER	A-UPPER	A-UPPER
A-LOWER	A-LOWER	A-LOWER
CONTROL	CONTROL	CONTROL
UPPER	UPPER	UPPER
LOWER	LOWER	LOWER
DRUMS	DRUMS	DRUMS
BASS	BASS	BASS
ACC 1	ACC 1	ACC 1
ACC 2	ACC 2	ACC 2
ACC 3	ACC 3	ACC 3
Rx. 1	Rx. 1	Rx. 1
Rx. 2	Rx. 2	Rx. 2

2 MIDI Channels of Parts / MIDI Filter

(1) Setting the MIDI Channels

The receive, transmit, extended transmit channels can be set for each Part.

Receive MIDI channel for playing a Part with the messages from the MIDI (KBD/SEQ) IN.

Transmit MIDI channel for transmitting the Style Performance messages from the MIDI (SEQ) OUT.

Extended transmit MIDI channel for transmitting the Style Performance messages from the MIDI (KBD) OUT.

① Press **MIDI**.

(The previous display appears.)

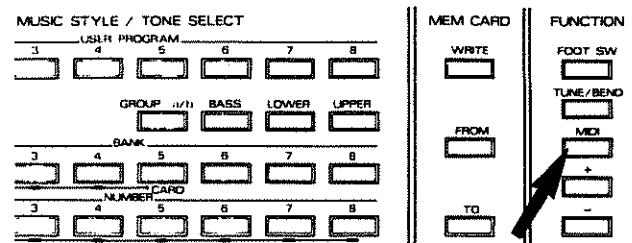

② Press USER PROGRAM **1**.

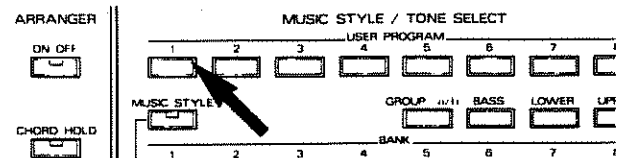

*Each time you press USER PROGRAM **1**, the display changes as "Rx. - Tx. - Ex. - Rx. ".

Rx. Channel & SW
A-UPPER= **ON**

↓ MIDI channel

Tx. Channel & SW
A-UPPER= **ON**

↓

Ex. Channel & SW
A-UPPER= **---**

③ Press **TO** (**MIDI**) and **FROM** to select the Part to be edited.

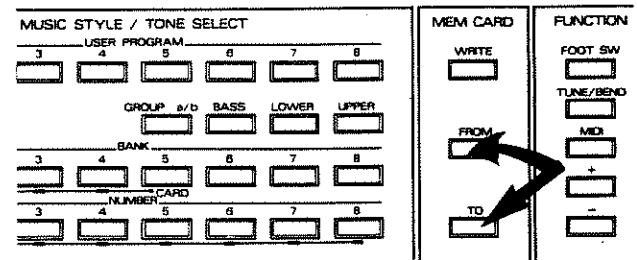

- ④ Set the channel using **+** or **-**.

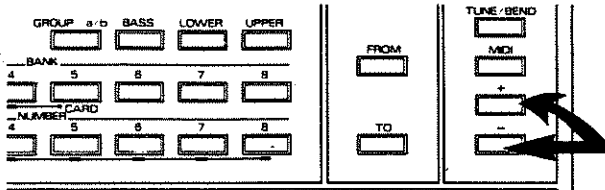

* Repeat steps 2 to 4 to set the channels of all Parts.

- ⑤ Press **MUSIC STYLE**.

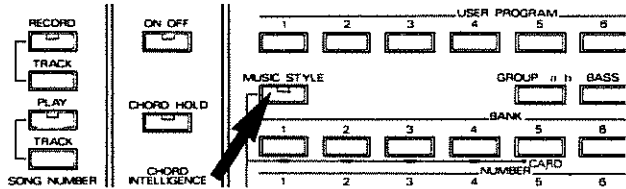

* To continue to set the other MIDI parameters, select the parameter with USER PROGRAM.

* If the keyboard connected to the MIDI (KBD) IN does not feature the function to change the MIDI channels, set the Arranger UPPER/LOWER's receive (Rx.) and transmit (Tx.) channels to the same number as the keyboard's channel. In this way, the Arranger function can be controlled from the connected keyboard.

* The MIDI channels of the Arranger UPPER/LOWER are MIDI receive channel that activates the Arranger function and transmit channel used for Bypass On. (MIDI (SEQ) OUT = transmit, MIDI (KBD) OUT extended transmit)

* MIDI channel of CONTROL is the channel on which Program Change messages for changing Music Styles are transmitted and received.

< Factory Preset >

Part	Receive (Rx.)	Transmit (Tx.)	Extended Transmit (Ex.)
A-UPPER	1	1	-
A-LOWER	1	1	-
CONTROL	1 6	1 6	-
UPPER	4	* 4	4
LOWER	3	* 3	3
BASS	2	* 2	2
DRUMS	1 0	* 1 0	1 0
ACCOMP1	5	* 5	5
ACCOMP2	6	* 6	6
ACCOMP3	7	* 7	7
Rx. 1	8	* 8	8
Rx. 2	9	* 9	9

* The numbers darkened with gray are restored each time the unit is switched on.

(2) On/Off of MIDI

This determines whether or not to use MIDI receive, transmit and extended transmit channel of each Part.

- ① Press **MIDI**.

(The previous display is retrieved.)

- ② Press USER PROGRAM **2**.

* Each time you press USER PROGRAM **2**, the display changes as "Rx. - Tx. - Ex. - Rx."

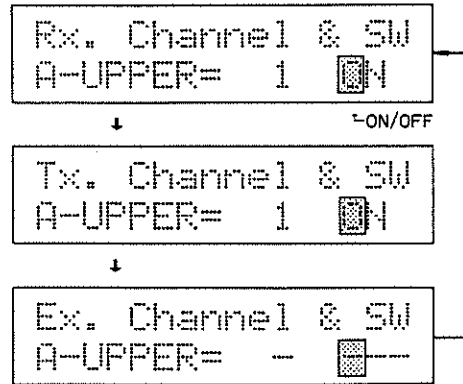

- ③ Select the Part to be edited with **TO** (**MIDI**) or **FROM**.

- ④ Set ON or OFF using **+** or **-**.

● Repeat steps 2 to 4 to set On/Off of the other Parts.

- ⑤ When you finish, press **MUSIC STYLE**.

* To continue to edit the other MIDI functions, select the function to be edited with USER PROGRAM.

< Factory Preset >

Part	Receive (Rx.)	Transmit (Tx.)	Extended Transmit (Ex.)
A-UPPER	ON	ON	-
A-LOWER	ON	ON	-
CONTROL	ON	ON	-
UPPER	ON	* ON	OFF
LOWER	ON	* ON	OFF
BASS	ON	* ON	OFF
DRUMS	ON	* ON	OFF
ACCOMP1	ON	* ON	OFF
ACCOMP2	ON	* ON	OFF
ACCOMP3	ON	* ON	OFF
Rx. 1	ON	* ON	OFF
Rx. 2	ON	* ON	OFF

* The ON or OFF settings darkened with gray are restored each time the unit is switched on.

(3) On/Off of Program Change

This determines whether to use Program Change (Tone Selection messages) or not.

- ① Press **MIDI**.

(The previous display is retrieved.)

- ② Press USER PROGRAM **3**.

* Each time you press USER PROGRAM **3**, the display changes as "Rx. - Tx. - Ex. - Rx."

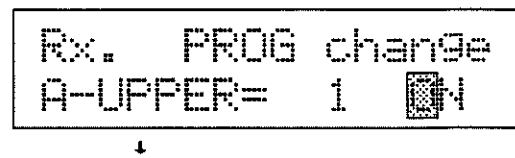

Tx. PROG change
A-UPPER= 1

EX. PROG change
A-UPPER= -

③ Select the Part to be edited with **TO** (**MIDI**) or **FROM**.

④ Set ON or OFF using **+** or **-**.

● Repeat steps ② to ④ to set On/Off of the other Parts.

⑤ When you finish, press **MUSIC STYLE**.

* To continue to edit the other MIDI functions, select the function to be edited with USER PROGRAM.

* In the Arranger UPPER/LOWER Parts, the received Program Change messages are output through MIDI OUT according to the Bypass setting.

* In the UPPER, LOWER, BASS, ACCOMP1, ACCOMP2, ACCOMP3, Rx.1 and Rx.2 Parts, Tones are changed by receiving Program Change messages. Program Change messages are transmitted from these Parts when Tones are changed with User Program or Music Style data. Extended transmission transmits Program Change according to the Program Change map.

<Program Change Numbers and corresponding Tones>

PROG #	TONE NAME	PROG #	TONE NAME	PROG #	TONE NAME	PROG #	TONE NAME
1	Acou Piano 1	33	Fantasy	65	Acou Bass 1	97	Brs Sect 2
2	Acou Piano 2	34	Harmo Pan	66	Acou Bass 2	98	Vibe 1
3	Acou Piano 3	35	Chorale	67	Elec Bass 1	99	Vibe 2
4	Elec Piano 1	36	Glasses	68	Elec Bass 2	100	Syn Mallet
5	Elec Piano 2	37	Soundtrack	69	Slap Bass 1	101	Windbell
6	Elec Piano 3	38	Atmosphere	70	Slap Bass 2	102	Glock
7	Elec Piano 4	39	Warm Bell	71	Fretless 1	103	Tube Bell
8	Honkytonk	40	Funny Vox	72	Fretless 2	104	Xylophone
9	Elec Org 1	41	Echo Bell	73	Flute 1	105	Marimba
10	Elec Org 2	42	Ice Rain	74	Flute 2	106	Koto
11	Elec Org 3	43	Oboe 2001	75	Piccolo 1	107	Sho
12	Elec Org 4	44	Echo Pan	76	Piccolo 2	108	Shakuhachi
13	Pipe Org 1	45	DoctorSolo	77	Recorder	109	Whistle 1
14	Pipe Org 2	46	Schooldaze	78	Pan Pipes	110	Whistle 2
15	Pipe Org 3	47	Bellsinger	79	Sax 1	111	Bottleblow
16	Accordion	48	Square Wave	80	Sax 2	112	Breathpipe
17	Harpsi 1	49	Str Sect 1	81	Sax 3	113	Timpani
18	Harpsi 2	50	Str Sect 2	82	Sax 4	114	Melodic Tom
19	Harpsi 3	51	Str Sect 3	83	Clarinet 1	115	Deep Snare
20	Clavi 1	52	Pizzicato	84	Clarinet 2	116	Elec Perc 1
21	Clavi 2	53	Violin 1	85	Oboe	117	Elec Perc 2
22	Clavi 3	54	Violin 2	86	Engl Horn	118	Taiko
23	Celesta 1	55	Cello 1	87	Bassoon	119	Taiko Rim
24	Celesta 2	56	Cello 2	88	Harmonica	120	Cymbal
25	Syn Brass 1	57	Contrabass	89	Trumpet 1	121	Castanets
26	Syn Brass 2	58	Harp 1	90	Trumpet 2	122	Triangle
27	Syn Brass 3	59	Harp 2	91	Trombone 1	123	Orche Hit
28	Syn Brass 4	60	Guitar 1	92	Trombone 2	124	Telephone
29	Syn Bass 1	61	Guitar 2	93	Fr Horn 1	125	Bird Tweet
30	Syn Bass 2	62	Elec Gtr 1	94	Fr Horn 2	126	One NoteJam
31	Syn Bass 3	63	Elec Gtr 2	95	Tuba	127	Water Bells
32	Syn Bass 4	64	Sitar	96	Brs Sect 1	128	Jungle Tune

* Program Change in CONTROL changes Music Styles. When Program Change is received on the MIDI channel of the CONTROL Part, the Music Styles change as shown next. When Music Styles are changed on the RA-50, the following Program Change numbers are transmitted.

< Program Change in the CONTROL Part >

Prog#	M. Style	Prog#	M. Style	Prog#	M. Style
1	INT 11	33	----	65	CARD 11
2	INT 12	34	----	66	CARD 12
3	INT 13	35	----	67	CARD 13
4	INT 14	36	----	68	CARD 14
5	INT 15	37	----	69	CARD 15
6	INT 16	38	----	70	CARD 16
7	INT 17	39	----	71	CARD 17
8	INT 18	40	----	72	CARD 18
9	INT 21	41	----	73	----
10	INT 22	42	----	74	----
11	INT 23	43	----	75	----
12	INT 24	44	----	76	----
13	INT 25	45	----	77	----
14	INT 26	46	----	78	----
15	INT 27	47	----	79	----
16	INT 28	48	----	80	----
17	INT 31	49	----	81	----
18	INT 32	50	----	82	----
19	INT 33	51	----	83	----
20	INT 34	52	----	84	----
21	INT 35	53	----	85	----
22	INT 36	54	----	86	----
23	INT 37	55	----	87	----
24	INT 38	56	----	88	----
25	INT 41	57	----	89	----
26	INT 42	58	----	90	----
27	INT 43	59	----	91	----
28	INT 44	60	----	92	----
29	INT 45	61	----	93	----
30	INT 46	62	----	94	----
31	INT 47	63	----	95	----
32	INT 48	64	----	96	----

Prog#	Music Style
97	USER PROGRAM 1
98	USER PROGRAM 2
99	USER PROGRAM 3
100	USER PROGRAM 4
101	USER PROGRAM 5
102	USER PROGRAM 6
103	USER PROGRAM 7
104	USER PROGRAM 8
105	BREAK ON
106	----
107	----
108	----
109	----
110	----
111	----
112	----
113	SYNC +INTRO
114	ENDING
115	FILL IN (TO ORIGINAL)
116	FILL IN (TO VARIATION)
117	RHYTHM (ORIGINAL)
118	RHYTHM (VARIATION)
119	ARRANGER (BASIC)
120	ARRANGER (ADVANCED)
121	MELODY INTELLIGENCE OFF
122	MELODY INTELLIGENCE ON
123	CHORD INTELLIGENCE OFF
124	CHORD INTELLIGENCE ON
125	CHORD HOLD OFF
126	CHORD HOLD ON
127	ARRANGER OFF
128	ARRANGER ON

* Program Change numbers shown as ---- are ignored even when received.

* Pressing relevant buttons transmits the corresponding Program Change number. When a Program Change number is received, the RA-50 reacts as if the relevant buttons on the RA-50 were pressed.

< Factory Preset >

Part	Receive(Rx.)	Transmit(Tx.)	Extended Transmit(Ex.)
A-UPPER	(OFF)	(OFF)	(OFF)
A-LOWER	(OFF)	(OFF)	(OFF)
CONTROL	ON	(ON)	(ON)
UPPER	ON	*ON	OFF
LOWER	ON	*ON	OFF
BASS	ON	*ON	OFF
DRUMS	ON	*ON	OFF
ACCOMP1	ON	*ON	OFF
ACCOMP2	ON	*ON	OFF
ACCOMP3	ON	*ON	OFF
Rx. 1	ON	*ON	OFF
Rx. 2	ON	*ON	OFF

* The ON or OFF settings shown in () cannot be edited.

* The ON or OFF settings darkened with gray are restored each time the unit is switched on.

(4) On/Off of Control Change

This determines whether or not to use Control Change for each Part.

① Press **MIDI**.

(The previous display is retrieved.)

② Press USER PROGRAM **4**.

*Each time you press USER PROGRAM **4**, the display changes as "Rx. - Tx. - Ex. - Rx."

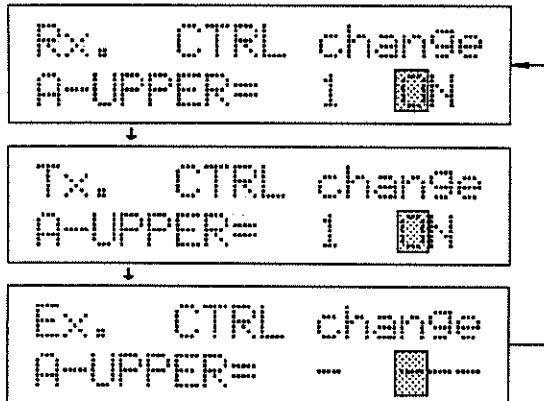

③ Select the Part to be edited with **TO** (**MIDI**) or **FROM**.

④ Set ON or OFF using **+** or **-**.

● Repeat steps ② to ④ to set On/Off of the other Parts.

⑤ When you finish, press **MUSIC STYLE**.

*To continue to edit the other MIDI functions, select the function to be edited with USER PROGRAM.

The following are the Control Changes that can be received and transmitted.

CTRL#	Name	Description
1	Modulation	Creates vibrato effect.
6	Data Entry	Used for RPN.
7	Volume	Adjusts the volume.
10	Panpot	Controls the sound positioning.
11	Expression	Controls the volume.
64	Hold 1	Stretches the sound.
100, 101	RPN	Controls parameters. *1
121	Reset All Controllers	Resets all the controllers.

*1:RPN 0 Controls the maximum range of the pitch change caused by the pitch bender.

<Factory Preset>

Part	Receive (Rx.)	Transmit (Tx.)	Extended Transmit (Ex.)
A-UPPER	ON	--	--
A-LOWER	ON	--	--
CONTROL	ON	--	--
UPPER	ON	*ON	OFF
LOWER	ON	*ON	OFF
BASS	ON	*ON	OFF
DRUMS	ON	*ON	OFF
ACCOMP1	ON	*ON	OFF
ACCOMP2	ON	*ON	OFF
ACCOMP3	ON	*ON	OFF
Rx. 1	ON	*ON	OFF
Rx. 2	ON	*ON	OFF

3 Other MIDI Settings

(1) Setting the Sync Mode

In the Sync Mode, you must set whether to control the tempo on the RA-50 or from external MIDI clocks. Also, you can set whether or not to output MIDI clocks through the MIDI (SEQ) OUT.

① Press **MIDI**.

(The previous display is retrieved.)

② Press USER PROGRAM **5**.

*Each time you press USER PROGRAM **5**, the display changes as "Rx. - Tx. - Ex. - Rx."

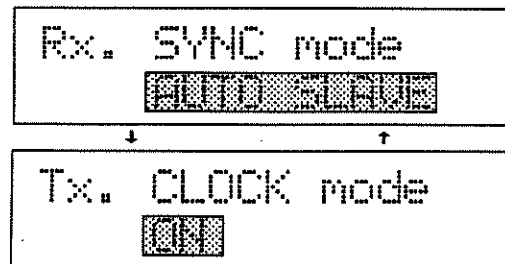

③ Select either of the values shown in the display with **+** or **-**.

The following describes the indication in the display.

Rx. SYNC mode Sync Mode (Rx.)

AUTO SLAVE Normally, Start/Stop and tempo are controlled by the RA-50. However, if the RA-50 receives Start or Continue message from the MIDI (SEQ) IN or MIDI (KBD) IN without Style Performance being played, it syncs to the MIDI clock from the MIDI (SEQ) IN or MIDI (KBD) IN. (When the RA-50 receives Stop message, it is returned to normal.)

REMOTE The Style Performance is started or stopped by Start, Continue or Stop message received through the MIDI (SEQ) IN. The tempo, however, is controlled by the RA-50. (MIDI clocks are ignored.)

OFF Start/Stop and tempo are controlled by the RA-50. Select this when you use the RA-50 as a sound module just like the MT-32.

TX. CLOCK mode Clock Transmit (Tx)

ON Transmits MIDI clocks from the MIDI (SEQ) OUT.
 OFF Does not transmit MIDI clocks from the MIDI (SEQ) OUT.

④ When you finish, press **MUSIC STYLE**.

* To continue to edit the other MIDI functions, select the function to be edited with **USER PROGRAM**.

< Factory Preset >

Rx SYNC mode	AUTO SLAVE
Tx CLOCK mode	ON

(2) Setting the Bypass Mode

You must select what kind of MIDI messages are transmitted from the MIDI OUT with **BYPASS** set to on.

① Press **MIDI**.

(The previous display is retrieved.)

② Press **USER PROGRAM** **6**.

③ Select the Arranger UPPER or LOWER which you wish to edit with **TO** (**MIDI**) or **FROM**.

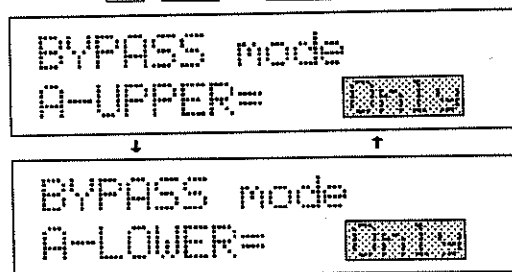

④ Select either of the indication in the display using **+** or **-**.

The following describes the indication in the display.

Only When the Bypass is set to off, only the RA-50's internal sound module will be played by performance messages received at MIDI (KBD) IN (performance messages are not output from the MIDI (KBD) OUT). When the Bypass is turned on, performance messages from the MIDI (KBD) IN are output through the MIDI (KBD) OUT (the internal sound module of the RA-50 is not played).

Both When the Bypass is set to off, only the RA-50's internal sound module will be played by performance messages sent through MIDI (KBD) IN (performance messages are not output from the MIDI (KBD) OUT). When the Bypass is turned on, the internal sound module of the RA-50 is played by the performance messages received through the MIDI (KBD) IN and the performance messages are output from the MIDI (KBD) OUT.

●Only

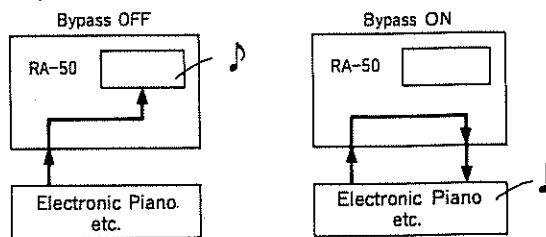

●Both

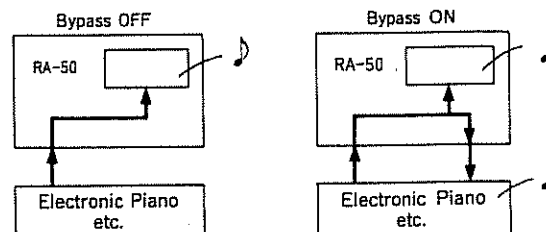

④ When you finish, press **MUSIC STYLE**.

* To continue to edit the other MIDI functions, select the function to be edited with **USER PROGRAM**.

< Factory Preset >

A-UPPER	Only
A-LOWER	Only

(3) Selecting a Program Change Map

A Program Change Map shows how the Program numbers are assigned to the actual sound numbers of the sound module. The six types of Program Change maps we have here are accompanied with the Program numbers that will be transmitted on the Extended transmit channel when tones on the RA-50 are changed. By using a different Program Change map, the assignment of the Program numbers to the sounds in the RA-50 or external sound module will change. As well as the six Program Change maps, you can select E-20 or MT-32 mode that determines what sound is actually selected by a sound number you assign using the panel switches.

① Press **MIDI**.

(The previous display is retrieved.)

② Press **USER PROGRAM** **7**.

* Each time you press **USER PROGRAM** **7**, the Panel (PANEL PROG MAP) and Map (Ex. PROG MAP) setting display will be alternately called.

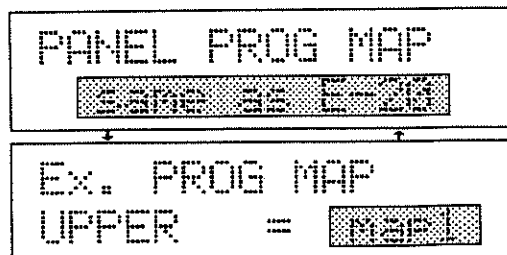

Panel In this display, you select whether to change RA-50's tones in the same sequence as the E-20 or MT-32.

Map In this display, you select one of the six Program Change maps for each Part.

③ In the Map display, select the Part to be edited with **TO** (MIDI) or FROM.

④ Select a map using **+** or **-**.

The following describes the indication in the display.

Panel

same as E-20 When you change tones on the RA-50 using the panel switches, the tones are changed in the same sequence as the E-20.
 same as MT-32 When you change tones on the RA-50 using the panel switches, the tones are changed in the same sequence as the MT-32.

< Factory Preset (same as E-20, same as MT-32) >

E-20	MT-32	TONES	
A11	1	A14	ELEC PIANO 1
A12	2	A15	ELEC PIANO 2
A13	3	A16	ELEC PIANO 3
A14	4	A18	HONKYTONK
A15	5	A31	HARPSI 1
A16	6	A34	CLAVI 1
A17	7	A37	CELESTA 1
A18	8	A82	HARP 1
A21	9	A21	ELEC ORGAN 1
A22	10	A22	ELEC ORGAN 2
A23	11	A23	ELEC ORGAN 3
A24	12	A25	PIPE ORGAN 1
A25	13	A26	PIPE ORGAN 2
A26	14	B68	BRETHPIPE
A27	15	B64	SHAKUHACHI
A28	16	A28	ACCORDION
A31	17	A41	SYN BRASS 1
A32	18	A42	SYN BRASS 2
A33	19	A43	SYN BRASS 3
A34	20	B41	TRUMPET 1
A35	21	B43	TRONBONE 1
A36	22	B45	FRENCH HORN
A37	23	B48	BRASS SECT 1
A38	24	B27	SAX 1
A41	25	A71	STRING SECT 1
A42	26	A72	STRING SECT 2
A43	27	A74	PIZZICATO
A44	28	A75	VIOLIN 1
A45	29	B83	ORCH HIT
A46	30	A53	CHORALE
A47	31	A55	SOUNDTRACK
A48	32	B65	WHISTLE 1

E-20	MT-32	TONES	
B11	65	A11	ACOU PIANO 1
B12	66	A12	ACOU PIANO 2
B13	67	A13	ACOU PIANO 3
B14	68	A14	ELEC PIANO 4
B15	69	A21	ELEC ORG 4
B16	70	A27	PIPE ORG 3
B17	71	A32	HARPSI 2
B18	72	A33	HARPSI 3
B21	73	A35	CLAVI 2
B22	74	A36	CLAVI 3
B23	75	A38	CELESTA 2
B24	76	A44	SYN BRASS 4
B25	77	A45	SYN BASS 1
B26	78	A46	SYN BASS 2
B27	79	A47	SYN BASS 3
B28	80	A48	SYN BASS 4
B31	81	A52	HARMO PAN
B32	82	A54	GLASSES
B33	83	A58	FUNNY VOX
B34	84	A63	SBOE 2001
B35	85	A66	SCHOOLDAZE
B36	86	A67	BELLSINGER
B37	87	A73	STRING SECT 3
B38	88	A76	VIOLIN 2
B41	89	A77	CELLO 1
B42	90	A78	CELLO 2
B43	91	A83	HARP 2
B44	92	A88	SITAR
B45	93	B14	ELEC BASS 2
B46	94	B22	FLUTE 2
B47	95	B23	PICCOLO 1
B48	96	B24	PICCOLO 2

Map

map1 ~ map6 Six types of Program Change maps that are accompanied with the Program numbers that will be transmitted on the Extended transmit channel when tones on the RA-50 are changed.

● Repeat steps ② to ④.

⑤ When you finish, press **MUSIC STYLE**.

* To continue to edit the other MIDI functions, select the function to be edited with USER PROGRAM.

E-20	MT-32	TONES	
A51	33	A51	FANTASY
A52	34	A56	ATMOSPHERE
A53	35	A57	WARM BELL
A54	36	A61	ECHO BELL
A55	37	B87	WATER BELL
A56	38	A64	ECHO PAN
A57	39	A65	DOCTOR SOLO
A58	40	A68	SQUARE WAVE
A61	41	A84	GUITAR 1
A62	42	A85	GUITAR 2
A63	43	A86	ELEC GUITAR 1
A64	44	A87	ELEC GUITAR 2
A65	45	B21	FLUTE 1
A66	46	B26	PAN PIPES
A67	47	B33	CLARINET
A68	48	B38	HARMONICA
A71	49	B11	ACOU BASS 1
A72	50	B12	ACOU BASS 2
A73	51	B13	ELEC BASS 1
A74	52	B15	SLAP BASS 1
A75	53	B16	SLAP BASS 2
A76	54	B17	FRETLESS 1
A77	55	B18	FRETRESS 2
A78	56	A81	CONTRABASS
A81	57	B52	VIBE 1
A82	58	B53	VIBE 2
A83	59	B56	GLOCK
A84	60	B58	XYLOPHONE
A85	61	B61	MARIMBA
A86	62	B88	JUNGLE TUNE
A87	63	A62	ICE RAIN
A88	64	B84	TELEPHONE

E-20	MT-32	TONES	
B51	97	B25	RECORDER
B52	98	B28	SAX 2
B53	99	B31	SAX 3
B54	100	B32	SAX 4
B55	101	B34	CLARINET 2
B56	102	B35	OBOE
B57	103	B36	ENGLISH HORN
B58	104	B37	BASSOON
B61	105	B42	TRUMPET 2
B62	106	B44	TROMBONE 2
B63	107	B46	FRENCH HORN 2
B64	108	B47	TUBA
B65	109	B51	BRASS SECT 2
B66	110	B54	SYN MALLET
B67	111	B55	WINDBELL
B68	112	B57	TUBE BELL
B71	113	B62	KOTO
B72	114	B63	SHO
B73	115	B66	WHISTLE 2
B74	116	B67	BOTTLEBLOW
B75	117	B71	TIMPANI
B76	118	B72	MELODIC TOM
B77	119	B73	DEEP SNARE
B78	120	B74	ELEC PERC 1
B81	121	B75	ELEC PERC 2
B82	122	B76	TAIKO
B83	123	B77	TAIKO RIM
B84	124	B78	CYMBAL
B85	125	B81	CASTANETS
B86	126	B82	TRIANGLE
B87	127	B85	BIRD TWEET
B88	128	B86	ONE NOTE JAM

< Factory Preset >

Panel same as E-20

Map

Part	Map
A-UPPER	----
A-LOWER	----
CONTROL	----
UPPER	map1
LOWER	map2
BASS	map3
DRUMS	----
ACCOMP1	map4
ACCOMP2	map5
ACCOMP3	map6
Rx. 1	----
Rx. 2	----

(4) Editing a Program Change Map

In this Program Change Map, you can edit the assignment of the Program number (that will be transmitted on the Extended transmit channel) to the Tones on the RA-50 for each Program Change Map.

① Press **MIDI**.

(The previous display is retrieved.)

② Press **USER PROGRAM** **8**.



③ Select a map to be edited using **+** or **-**.

④ Press **WRITE**.

⑤ Select the source tone number (the number of the actual sound) using **GROUP a/b**, **BANK** and **NUMBER**.



⑥ Select the Program Number with **+** or **-**.



● Repeat steps ⑤ and ⑥.

⑦ Press **WRITE**.

⑧ Press **MUSIC STYLE**.

4

Using the RA-50 with a MIDI sequencer

(1) MIDI Sequencer

The RA-50's Song Composer can record the Style Performance and Upper/Lower performance. However, using a MIDI sequencer such as the MC-500MKII, you can enjoy more sophisticated ensemble and sync performance.

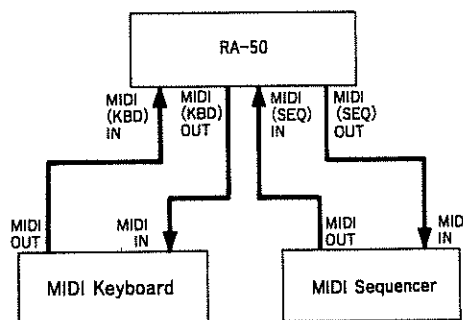

As shown in the picture, connect the sequencer to the MIDI (SEQ) IN and MIDI (SEQ) OUT. Use the MIDI (KBD) IN and MIDI (KBD) OUT for the connection of an electronic piano or MIDI keyboard.

(2) Control from a MIDI sequencer

By sending messages to the RA-50 through MIDI (SEQ) IN, the RA-50 can be used as a multi timbral sound module that features 8 individual synthesizer parts and one rhythm part.

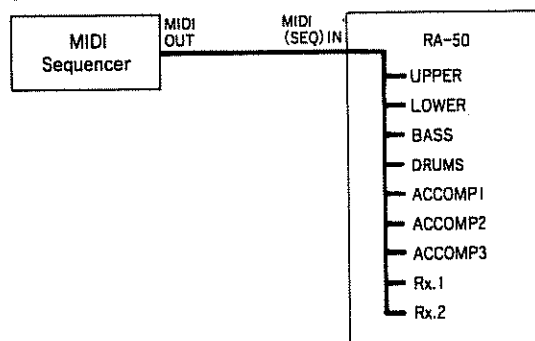

a. When not using the RA-50's Arranger Function

To record the performance played on the keyboard into a MIDI sequencer and play the recorded data on the RA-50, do as follows.

- ① Set the MIDI transmit channel of the keyboard and the receive channels (Rx.) of the A-UPPER/LOWER to the same number.
- ② Set the transmit channels (Tx.) of the A-UPPER/LOWER to the same number as the receive channel (Rx.) of the Part you wish to play.
- ③ Set the Rx.SYNC mode to OFF.
- ④ Record the performance into the MIDI sequencer.

For instance, to record into Rx.1 Part in the following settings, set the transmit channels (Tx.) of A-UPPER/LOWER to 8.

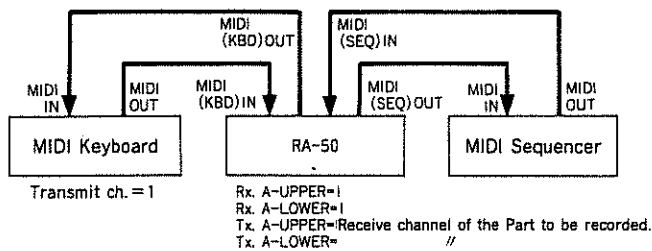

b. When using the RA-50's Arranger Function

When you record the Style Performance played with the Arranger function into a MIDI sequencer, individual performance messages such as Upper, Lower, Bass, Drums, etc. are transmitted on the respective transmit channels (Tx.). In other words, the data of the Style Performance is output in the original form as MIDI performance messages. Therefore, once it is recorded into a MIDI sequencer, it can be played using the RA-50 as a sound module (without using the RA-50's Arranger function).

- ① Set the Tx CLOCK mode of the RA-50 to ON.
- ② Set the Rx.SYNC mode to OFF.
- ③ Set the Clock (Sync) of the MIDI sequencer to MIDI or EXT (External).
- ④ Set the MIDI sequencer to the recording condition and start the RA-50, and recording starts automatically.

To play back the recorded data, set the Clock (Sync) of the MIDI sequencer back to INT (Internal).

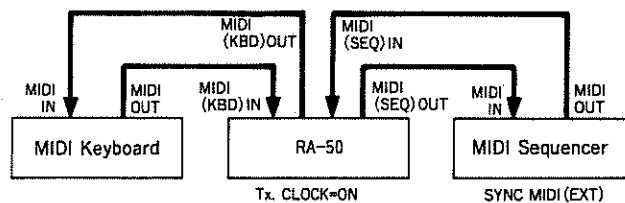

c. When using the RA-50's Arranger Function from the MIDI sequencer

The RA-50 can play the Style Performance with the MIDI messages sent from an external MIDI sequencer. The performance messages are not recorded in the sequencer, but the keyboard connected to the MIDI (KBD) IN and RA-50's panel operation can control the Style Performance.

- ① To record a performance, set the transmit (Tx) of all the Part except A-UPPER/LOWER and CONTROL to OFF.
- ② Set the Tx. CLOCK mode to ON, and Rx. SYNC mode to OFF.
- ③ Set the MIDI sequencer to the recording condition, and play the keyboard. The recording starts automatically.

- ④ To play back the recorded data, set the Rx. SYNC mode to AUTO SLAVE so that the MIDI sequencer can output MIDI clocks.

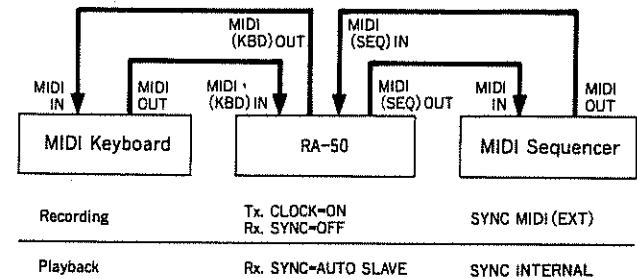

5 Using the RA-50 with a MIDI instrument other than a sequencer

(1) Computer (Sequence software)

Instead of the MIDI sequencer, you can use a computer + sequencer software. For instance, by connecting the sequence software to the RA-50, the RA-50 can be controlled by the sequence software.

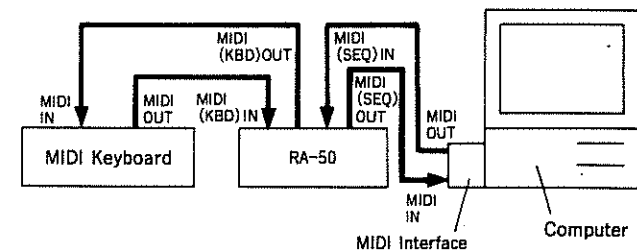

When the RA-50 is used as a sound module, it works almost the same as the MT-32. That is, you can follow the MT-32 for tone selection on the sequence software or the track performance.

Split Select	Chord Detecting Range	Lower Sound Range
SPLIT OFF	Zero	The entire keyboard
SPLIT G3	Lower than F#3	Higher than G3
SPLIT C4	Lower than B3	Higher than C4

* To obtain successful chord change, you may input chord data slightly forward.

* It is better to turn the Chord Hold on in playback.

(2) Guitar Synthesizer

The RA-50 can also be used for the guitar synthesizer's sound module. For example, for the MIDI Guitar Synthesizer system, GK-2 + GR-50, or for the GK-1 + GM-70.

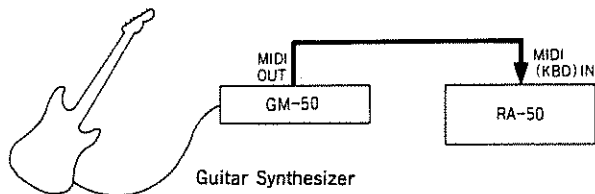

When you use the RA-50 as a sound module for a guitar synthesizer, set the receive channel (Rx.) of each Part to the individual string of the guitar. In this way, you can express the bending or vibrato effects that create realistic guitar performance. Also, the Style Performance can be played by a guitar synthesizer just like the MIDI keyboard.

- TROUBLE SHOOTING
- CHORD LIST
- USER'S SETTING MEMO
- MIDI IMPLEMENTATION
- SPECIFICATIONS
- INDEX

6

APPENDIX (REFERENCES)

■ Troubleshooting

(1) Error Messages

Error Messages shown when a Memory Card is being used :

CARD NOT READY

Cause : No Memory Card is connected.

What to do : Insert a Memory Card securely and repeat the procedure.

ILLEGAL CARD !!

Cause : 1. The connected Memory Card is brand new.
2. The connected Memory Card does not contain data for the RA-50, or a Music Style Card is connected.

What to do : 1. Write some data on the Card.
2. Replace with a proper Card contains the RA-50's data.

ILLEGAL CARD !!
WRITE AGAIN ?

Cause : 1. The connected Memory Card is brand new.
2. The connected Memory Card contains data for some other unit other than the RA-50.

What to do : 1. Press **WRITE** and write data onto the Card.
2. If you do not mind erasing the existing data, press **WRITE** again to write data of the RA-50.

CHECK CARD
BATTERY

Cause : The battery of the Memory Card is exhausted, or no battery is set to the Memory Card.

What to do : Replace with the battery with a new one (CR-2016).

MEMORY CARD
PROTECTED !

Cause : The protect switch on the Memory Card is set to the ON position.

What to do : Set the protect switch on the Memory Card to the OFF position, and repeat the procedure.

SAVE NOT
POSSIBLE !

Cause : You have tried to write data on the ROM (read only) Card such as a Music Style Card.

What to do : Replace the Card with a proper Memory Card for writing (M-256E/256D).

Error Message specific for the RA-50

CHECK INTERNAL
BATTERY

Cause : The RA-50's internal battery is exhausted.

What to do : Have the local Roland service replace the battery.

Error messages shown when using a Music Style Card

CARD NOT READY

Cause : No card is connected to the RA-50.

What to do : Connect the music Style Card securely and repeat the procedure.

ILLEGAL CARD !!

Cause : The connected Card is not a Music Style Card.

What to do : Replace the Card with a Music Style Card.

(2) Troubleshooting

No sound is generated.

- Cause:**
1. The Master Volume knob is set to the MIN position.
 2. The RA-50 is not connected securely with the Roland Piano.
 3. The volume of the connected piano or amplifier is set too low.
 4. The Part volume of BALANCE is set to zero or OFF.

- What to do:**
1. Raise the Master Volume knob until you can hear the sound.
 2. Connect the RA-50 securely with the external instrument.
 3. Raise the volume of the external units until you can hear the sound.
 4. Set the Part volume of BALANCE to the ON position, then increase the value until you can hear the sound.

* The RA-50 does not function properly for several seconds after being switched on.

Tones cannot be selected correctly.

Cause: You have selected the Upper Tone without pressing **UPPER** after selecting a Lower Tone (or vice versa).

What to do: The RA-50 continues to select a Tone of the previous Part. So, to select a Upper Tone after selecting a Lower Tone, you must press **UPPER**.

Quick phrases are difficult to hear.

Cause: You are playing a quick phrase using a soft sound with slow attack.

What to do: Some tones may be slow attack sounds and therefore are not suitable for quick phrases. (e.g. A47 SOUND TRACK). For quick phrases, use quick attack sounds, such as a guitar or piano.

Style Performance cannot be played.

Cause: The Arranger function is set to OFF.

What to do: When the Arranger function is set to OFF, Style Performance cannot be played. Set the Arranger function to ON.

Sound is cut during Style Performance. Melody Intelligence function cannot be obtained.

Cause: Many performance data are programmed in the same timing.

What to do: The maximum number of voices that the RA-50 can produce at the same time is 32. (A conventional synthesizer can produce only 8 to 24 voices.) However, for the Style performance, the RA-50 has to take many roles at the same time. Therefore, if you use many performance data of the same timing, the RA-50's voices may become short. When you use the Melody Intelligence function, be sure that sufficient number of voices are left free.

Sound does not stop.

Cause:

1. The Chord Hold function is turned on in the Split mode.
2. The MIDI cable is disconnected.

What to do:

1. Press **CHORD HOLD** to turn off the Chord Hold function.
2. Switch the unit off once and connect the cable securely.

Two sounds are mixed/the sound which is not selected is played.

Cause: You have pressed **MIDI** in FUNCTION.

What to do: If you change MIDI channels without carelessly, you may unexpectedly hear Lower Tone or Bass Tone when not using the Split function, or hear drum sound when not using the Manual Drums function. If this happens, switch the unit off, then switch it on again to

return to the normal condition.

* For explanation about MIDI, see page/72
"ADVANCED PROCEDURE".

When the Bypass Switch is on, the pitch of the RA-50 does not match that of the piano.

Cause: The RA-50 is not correctly tuned to the piano.

What to do: The Master Tune of a Roland Piano has been set to 442Hz from the manufacturer, so you must set the pitch of the RA-50 to the same value. Make sure that the tuning knob on the rear of the Roland Piano is set to the center position (=442Hz), press **TUNE/BEND** on the RA-50, then press **+** until the display shows "442.0Hz".

* When a different type of keyboard is used, find out the Master Tune value of the keyboard in its owner's manual, then set the RA-50's Master Tune to the same value.

If the unit does not function properly even after performing the above corrections, call your local Roland service.



[Faint, illegible text, possibly bleed-through from the reverse side of the page.]

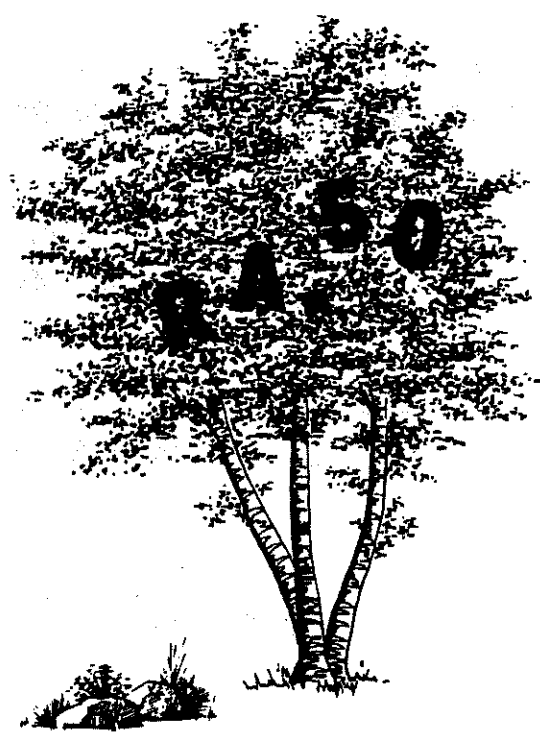

Chord List

CMa * C#Ma * DMa * EbMa * EMa * FMa

CMa7 * C#Ma7 * DMa7 * EbMa7 * EMa7 * FMa7

C7 * C#7 * D7 * Eb7 * E7 * F7 *

Cmi * C#mi * Dmi * Ebmi * Emi * Fmi *

Cmi7 * C#mi7 * Dmi7 * Ebmi7 * Emi7 * Fmi7 *

Cφ * C#φ * Dφ * Ebφ * Eφ * Fφ *

CDim * C#Dim * DDim * EbDim * EDim * FDim *

CAug C#Aug DAug EbAug EAug FAug

CSu4 C#Su4 DSu4 EbSu4 ESu4 FSu4

CSu7 C#Su7 DSu7 EbSu7 ESu7 FSu7

F#Ma* GMa* A bMa* AMa* B bMa* BMa*

F#Ma7* GMa7* A bMa7* AMa7* B bMa7* BMa7*

F#7* G7* A b7* A7* B b7* B7*

F#mi* Gmi* A bmi* Ami* B bmi* Bmi*

F#mi7* Gmi7* A bmi7* Ami7* B bmi7* Bmi7*

F#ø* Gø* A bø* Aø* B bø* Bø*

F#Dim* GDim* A bDim* ADim* B bDim* BDim*

F#Aug GAug A bAug AAug B bAug BAug

F#Su4 GSu4 A bSu4 ASu4 B bSu4 BSu4

F#Su7 GSu7 A bSu7 ASu7 B bSu7 BSu7

* All above chords attached "★" are the Intelligent Chords.

User's Setting Memo

TITLE : _____

DATE :

MUSIC STYLE		
CHORD INTELL.	ON	OFF
MELODY INTELL.	ON	OFF
CHORD HOLD	ON	OFF

TEMPO	J =		
SYNC START	ON	OFF	
INTRO	ON	OFF	

ARRANGER SELCT	ADVANCED	BASIC	OFF
VARIATION	ON	OFF	

MANUAL DRUMS	ON	OFF	
BYPASS	WHOLE	UPPER	OFF
SPLIT	G3	C4	OFF

	TONE		BALLANCE	
UPPER				OFF
LOWER				OFF
ACCOMP	----	-----		OFF
BASS				OFF
DRUMS	----	-----		OFF

REVERB		ON							OFF
PART ASSIGN	UPPER	YES				NO			
	LOWER	YES				NO			
	DRUMS	YES				NO			
REVERB TYPE		1	2	3	4	5	6	7	8

FOOT SWITCH	Pedal1								
	Pedal2								
	Pedal3								
BENDER RANGE		1	2	3	4	5	6	7	8

TITLE : _____

DATE : . . .

MUSIC STYLE		
CHORD INTELL.	ON	OFF
MELODY INTELL.	ON	OFF
CHORD HOLD	ON	OFF

TEMPO	J =		
SYNC START	ON	OFF	
INTRO	ON	OFF	

ARRANGER SELCT	ADVANCED	BASIC	OFF
VARIATION	ON	OFF	

MANUAL DRUMS	ON	OFF	
BYPASS	WHOLE	UPPER	OFF
SPLIT	G3	C4	OFF

	TONE		BALLANCE	
UPPER				OFF
LOWER				OFF
ACCOMP	----	-----		OFF
BASS				OFF
DRUMS	----	-----		OFF

REVERB		ON							OFF
PART ASSIGN	UPPER	YES				NO			
	LOWER	YES				NO			
	DRUMS	YES				NO			
REVERB TYPE		1	2	3	4	5	6	7	8

FOOT SWITCH	Pedal1								
	Pedal2								
	Pedal3								
BENDER RANGE		1	2	3	4	5	6	7	8

TITLE : _____

DATE : . . .

MUSIC STYLE		
CHORD INTELL.	ON	OFF
MELODY INTELL.	ON	OFF
CHORD HOLD	ON	OFF

TEMPO	♩ =	
SYNC START	ON	OFF
INTRO	ON	OFF

ARRANGER SELECT	ADVANCED	BASIC	OFF
VARIATION	ON	OFF	

MANUAL DRUMS	ON	OFF	
BYPASS	WHOLE	UPPER	OFF
SPLIT	G3	C4	OFF

	TONE		BALLANCE
UPPER			OFF
LOWER			OFF
ACCOMP	----	-----	OFF
BASS			OFF
DRUMS	----	-----	OFF

REVERB	ON								OFF
PART ASSIGN	UPPER	YES				NO			
	LOWER	YES				NO			
	DRUMS	YES				NO			
REVERB TYPE	1	2	3	4	5	6	7	8	

FOOT SWITCH	Pedal1								
	Pedal2								
	Pedal3								
BENDER RANGE	1	2	3	4	5	6	7	8	

1.ECHO - BACK SECTION

When using MIDI (KBD) IN and MIDI (KBD) OUT.

1.1 RECOGNIZED RECEIVE DATA (ECHO - BACK SECTION)

■ Channel Voice Message

● Note off

Status	Second	Third
8nH	kkH	vvH
9nH	kkH	00H

n = MIDI channel number : 0H - FH (0 - 15) 0 = ch.1 15 = ch.16
 kk = Note number : 00H - 7FH (0 - 127)
 vv = Velocity : 00H - 7FH (0 - 127)

● Note on

Status	Second	Third
9nH	kkH	vvH

n = MIDI channel number : 0H - FH (0 - 15) 0 = ch.1 15 = ch.16
 kk = Note number : 00H - 7FH (0 - 127)
 vv = Velocity : 01H - 7FH (1 - 127)

● Polyphonic key pressure

Status	Second	Third
AnH	kkH	vvH

n = MIDI channel number : 0H - FH (0 - 15) 0 = ch.1 15 = ch.16
 kk = Note number : 00H - 7FH (0 - 127)
 vv = Value : 00H - 7FH (0 - 127)

● Control change

Status	Second	Third
BnH	kkH	vvH

n = MIDI channel number : 0H - FH (0 - 15) 0 = ch.1 15 = ch.16
 kk = Control number : 00H - 79H (0 - 121)
 vv = Value : 00H - 7FH (0 - 127)

* Received when Rx.CTRL change is ON.
 * On Rx.A - UPPER, Rx.A - LOWER, Rx.CONTROL channels, always received control change. And transmitting for SOUND MODULE section when Rx.CTRL change is ON.

● Program change

Status	Second
CnH	ppH

n = MIDI channel number : 0H - FH (0 - 15) 0 = ch.1 15 = ch.16
 pp = Program number : 00H - 7FH (0 - 127)

* Received when Rx.PROG change is ON.
 * On Rx.A - UPPER, Rx.A - LOWER, Rx.CONTROL channels, always received program change. And transmitting for SOUND MODULE section when Rx.PROG change is ON.

● Channel pressure

Status	Second
DnH	vvH

n = MIDI channel number : 0H - FH (0 - 15) 0 = ch.1 15 = ch.16
 vv = Value : 00H - 7FH (0 - 127)

● Pitch bend change

Status	Second	Third
EnH	iiH	mmH

n = MIDI channel number : 0H - FH (0 - 15) 0 = ch.1 15 = ch.16
 mm,ii = Value : 00H,00H - 7FH,7FH 0 - 16383 (-8192 - +8191)

■ System Common Message

● Tune request

Status
F6H

■ System Realtime Message

● Timing clock

Status
FBH

* Recognized after receiving FAH or FBH at MIDI (KBD) IN, when Rx.SYNC mod is AUTO SLAVE.

● Start

Status
FAH

* Recognized when Rx.SYNC mode is AUTO SLAVE or REMOTE.

● Continue

Status
FBH

* Recognized when Rx.SYNC mode is AUTO SLAVE or REMOTE.
 * Recognized only as FAH.

● Stop

Status
FCH

* Recognized when Rx.SYNC mode is AUTO SLAVE or REMOTE.

■ System Exclusive Message

Status	data
F0H	iiH,ddH,...,eeH
F7H	

F0H : System Exclusive
 ii = ID number : 00H - 7FH (0 - 127)
 dd,...,ee = data : 00H - 7FH (0 - 127)
 F7H : EOX (End of Exclusive/System common)

* Received when System Exclusive is up to 300 bytes.

1.2 TRANSMITTED DATA (ECHO - BACK section)

■ Channel Voice Message

● Note off

Status	Second	Third
8nH	kkH	40H

n = MIDI channel number : 0H - FH (0 - 15) 0 = ch.1 15 = ch.16
 kk = Note number : 00H - 7FH (0 - 127)
 40 = Velocity : 40H (64)

● Note on

Status	Second	Third
9nH	kkH	vvH

n = MIDI channel number : 0H - FH (0 - 15) 0 = ch.1 15 = ch.16
 kk = Note number : 00H - 7FH (0 - 127)
 vv = Velocity : 01H - 7FH (1 - 127)

● Polyphonic key pressure

Status	Second	Third
AnH	kkH	vvH

n = MIDI channel number : 0H - FH (0 - 15) 0 = ch.1 15 = ch.16
 kk = Note number : 00H - 7FH (0 - 127)
 vv = Value : 00H - 7FH (0 - 127)

* Can be SOFT THRU when received.

● Control change

Status	Second	Third
BnH	kkH	vvH

n = MIDI channel number : 0H - FH (0 - 15) 0 = ch.1 15 = ch.16
 kk = Control number : 00H - 79H (0 - 121)
 vv = Value : 00H - 7FH (0 - 127)

* Can be SOFT THRU when Tx.CTRL change is ON.
 * On Tx.A - UPPER, Tx.A - LOWER, Tx.CONTROL channels, always do SOFT THRU the control change.

● Program change

Status	Second
CnH	ppH

n = MIDI channel number : 0H - FH (0 - 15) 0 = ch.1 15 = ch.16
 pp = Program number : 00H - 7FH (0 - 127)

* Can be SOFT THRU when Tx.PROG change is ON.
 * On Tx.A - UPPER, Tx.A - LOWER, Tx.CONTROL channels, always do SOFT THRU the program change.

● Channel pressure

Status	Second
DnH	vvH

n = MIDI channel number : 0H - FH (0 - 15) 0 = ch.1 15 = ch.16
 vv = Value : 00H - 7FH (0 - 127)

* Can be SOFT THRU when received.

● Pitch bend change

Status	Second	Third
EnH	iiH	mmH

n = MIDI channel number : 0H - FH (0 - 15) 0 = ch.1 15 = ch.16
 mm,ii = Value : 00H,00H - 7FH,7FH 0 - 16383 (-8192 - +8191)

* Can be SOFT THRU when received.

■ Channel Mode Message

● LOCAL CONTROL

Status	Second	Third
BnH	7AH	00H

n = MIDI channel number : 0H - FH (0 - 15) 0 = ch.1 15 = ch.16
 00 = Value : 00H (0) ; LOCAL OFF

* LOCAL OFF transmitted on Tx.A - UPPER and Tx.A - LOWER channels, when power is first applied.

● OMNI OFF

Status	Second	Third
BnH	7CH	00H

* OMNI OFF transmitted on Tx.A - UPPER and Tx.A - LOWER channels, when power is first applied.

■ System Common Message

● Tune request

Status
F6H

■ System Realtime Message

● Timing clock

Status
F8H

* Transmitted when Tx.CLOCK mode is ON.

● Start

Status
FAH

● Stop

Status
FCH

● Active sensing

Status
FEH

* Always transmitted up to 300msec.

■ System Exclusive Message

Status	data
F0H	iiH,ddH.....eeH
F7H	

F0H : System Exclusive
 ii = iD number : 00H - 7FH (0 - 127)
 dd.....ee = data : 00H - 7FH (0 - 127)
 F7H : EOX (End of Exclusive/System common)

* Can be SOFT THRU when System Exclusive is up to 300 bytes.

2. ARRANGER SECTION

When using MIDI (SEQ) IN and MIDI (SEQ) OUT.

2.1. RECOGNIZED RECEIVE DATA (ARRANGER SECTION)

■ Channel Voice Message

● Note off

Status	Second	Third
BnH	kkH	vvH
SnH	kkH	00H

n = MIDI channel number : 0H - FH (0 - 15) 0 = ch.1 15 = ch.16
 kk = Note number : 00H - 7FH (0 - 127)
 vv = Velocity : 00H - 7FH (0 - 127)

● Note on

Status	Second	Third
SnH	kkH	vvH

n = MIDI channel number : 0H - FH (0 - 15) 0 = ch.1 15 = ch.16
 kk = Note number : 00H - 7FH (0 - 127)
 vv = Velocity : 01H - 7FH (1 - 127)

● Polyphonic key pressure

Status	Second	Third
AnH	kkH	vvH

n = MIDI channel number : 0H - FH (0 - 15) 0 = ch.1 15 = ch.16
 kk = Note number : 00H - 7FH (0 - 127)
 vv = Value : 00H - 7FH (0 - 127)

● Control change

Status	Second	Third
BnH	kkH	vvH

n = MIDI channel number : 0H - FH (0 - 15) 0 = ch.1 15 = ch.16
 kk = Control number : 00H - 79H (0 - 121)
 vv = Value : 00H - 7FH (0 - 127)

* Received when Rx.CTRL change is ON.

* On Rx.A - UPPER, Rx.A - LOWER, Rx.CONTROL channels, always received control change. And transmitting for SOUND MODULE section when Rx.CTRL change is ON.

● Program change

Status	Second
CnH	ppH

n = MIDI channel number : 0H - FH (0 - 15) 0 = ch.1 15 = ch.16
 pp = Program number : 00H - 7FH (0 - 127)

* Received when Rx.PROG change is ON.

* On Rx.A - UPPER, Rx.A - LOWER, Rx.CONTROL channels, always received program change. And transmitting for SOUND MODULE section when Rx.PROG change is ON.

● Channel pressure

Status	Second
DnH	vvH

n = MIDI channel number : 0H - FH (0 - 15) 0 = ch.1 15 = ch.16
 vv = Value : 00H - 7FH (0 - 127)

● Pitch bend change

Status	Second	Third
EnH	llH	mmH

n = MIDI channel number : 0H - FH (0 - 15) 0 = ch.1 15 = ch.16
 mm, ll = Value : 00H, 00H - 7FH, 7FH 0 - 16383 (-8192 - +8191)

■ System Common Message

● Tune request

Status
F6H

■ System Realtime Message

● Timing clock

Status
F8H

* Recognized after receiving FAH or FBH at MIDI (SEQ) IN, when Rx.SYNC mod is AUTO SLAVE.

● Start

Status
FAH

* Recognized when Rx.SYNC mode is AUTO SLAVE or REMOTE.

● Continue

Status
FBH

* Recognized when Rx.SYNC mode is AUTO SLAVE or REMOTE.
 * Recognized only as FAH.

● Stop

Status
FCH

* Recognized when Rx.SYNC mode is AUTO SLAVE or REMOTE.

■ System Exclusive Message

Status	data
F0H	iiH, ddH, ..., eeH
F7H	
F0H	: System Exclusive
ii = ID number	: 00H - 7FH (0 - 127)
dd, ..., ee = data	: 00H - 7FH (0 - 127)
F7H	: EOX (End of Exclusive/System common)

* Received when System Exclusive is up to 300 bytes.
 Using System Exclusive Communications, refer to Sections 5 - 8.

2.2 TRANSMITTED DATA (ARRANGER SECTION)

■ Channel Voice Message

● Note off

Status	Second	Third
BnH	kkH	40H

n = MIDI channel number : 0H - FH (0 - 15) 0 = ch.1 15 = ch.16
 kk = Note number : 00H - 7FH (0 - 127)
 40 = Velocity : 40H (64)

● Note on

Status	Second	Third
SnH	kkH	vvH

n = MIDI channel number : 0H - FH (0 - 15) 0 = ch.1 15 = ch.16
 kk = Note number : 00H - 7FH (0 - 127)
 vv = Velocity : 01H - 7FH (1 - 127)

● Polyphonic key pressure

<u>Status</u>	<u>Second</u>	<u>Third</u>	
AnH	kkH	vvH	
n = MIDI channel number	: 0H - FH (0 - 15)	0 = ch.1 15 = ch.16	
kk = Note number	: 00H - 7FH (0 - 127)		
vv = Value	: 00H - 7FH (0 - 127)		

* Can be SOFT THRU when received.

● Control change

<u>Status</u>	<u>Second</u>	<u>Third</u>	
BnH	kkH	vvH	
n = MIDI channel number	: 0H - FH (0 - 15)	0 = ch.1 15 = ch.16	
kk = Control number	: 00H - 79H (0 - 121)		
vv = Value	: 00H - 7FH (0 - 127)		

* Transmitted when Tx.CTRL change is ON.
* Can be SOFT THRU when received.

● Program change

<u>Status</u>	<u>Second</u>	
CnH	ppH	
n = MIDI channel number	: 0H - FH (0 - 15)	0 = ch.1 15 = ch.16
pp = Program number	: 00H - 7FH (0 - 127)	

* Transmitted when Tx.PROG change is ON.
* Can be SOFT THRU when received.

● Channel pressure

<u>Status</u>	<u>Second</u>	
DnH	vvH	
n = MIDI channel number	: 0H - FH (0 - 15)	0 = ch.1 15 = ch.16
vv = Value	: 00H - 7FH (0 - 127)	

* Can be SOFT THRU when received.

● Pitch bend change

<u>Status</u>	<u>Second</u>	<u>Third</u>	
EnH	llH	mmH	
n = MIDI channel number	: 0H - FH (0 - 15)	0 = ch.1 15 = ch.16	
mm,ll = Value	: 00H,00H - 7FH,7FH	0 - 16383 (-8192 - +8191)	

* Can be SOFT THRU when received.

■ System Common Message

● Tune request

Status
F6H

■ System Realtime Message

● Timing clock

Status
F8H

* Transmitted when Tx.CLOCK mode is ON.

● Start

Status
FAH

● Continue

Status
FBH

● Stop

Status
FCH

● Active sensing

Status
FEH

* Always transmitted up to 300msec.

■ System Exclusive Message

<u>Status</u>	<u>data</u>
F0H	iiH,ddH,.....eeH
F7H	
F0H	: System Exclusive
ii = ID number	: 00H - 7FH (0 - 127)
dd,.....ee = data	: 00H - 7FH (0 - 127)
F7H	: EOx (End of Exclusive/System common)

* Received when System Exclusive is up to 300 bytes.
Using System Exclusive Communications, refer to Sections 5 - 8.

3. EXPANDED SECTION

When using MIDI (SEQ) IN and MIDI (KBD) OUT.

3.1 RECOGNIZED RECEIVED DATA (EXPANDED SECTION)

■ Channel Voice Message

● Note off

<u>Status</u>	<u>Second</u>	<u>Third</u>	
BnH	kkH	vvH	
9nH	kkH	00H	
n = MIDI channel number	: 0H - FH (0 - 15)	0 = ch.1 15 = ch.16	
kk = Note number	: 00H - 7FH (0 - 127)		
vv = Velocity	: 00H - 7FH (0 - 127)		

● Note on

<u>Status</u>	<u>Second</u>	<u>Third</u>	
9nH	kkH	vvH	
n = MIDI channel number	: 0H - FH (0 - 15)	0 = ch.1 15 = ch.16	
kk = Note number	: 00H - 7FH (0 - 127)		
vv = Velocity	: 01H - 7FH (1 - 127)		

● Polyphonic key pressure

<u>Status</u>	<u>Second</u>	<u>Third</u>	
AnH	kkH	vvH	
n = MIDI channel number	: 0H - FH (0 - 15)	0 = ch.1 15 = ch.16	
kk = Note number	: 00H - 7FH (0 - 127)		
vv = Value	: 00H - 7FH (0 - 127)		

● Control change

<u>Status</u>	<u>Second</u>	<u>Third</u>	
BnH	kkH	vvH	
n = MIDI channel number	: 0H - FH (0 - 15)	0 = ch.1 15 = ch.16	
kk = Control number	: 00H - 79H (0 - 121)		
vv = Value	: 00H - 7FH (0 - 127)		

* Received when Rx.CTRL change is ON.

* On Rx.A - UPPER, Rx.A - LOWER, Rx.CONTROL channels, always received control change. And transmitting for SOUND MODULE section when Rx.CTRL change is ON.

● Program change

Status Second
CnH ppH

n = MIDI channel number : 0H - FH (0 - 15) 0 = ch.1 15 = ch.16
pp = Program number : 00H - 7FH (0 - 127)

* Received when Rx.PROG change is ON.
* On Rx.A - UPPER, Rx.A - LOWER, Rx.CONTROL channels, always received program change. And transmitting for SOUND MODULE section when Rx.PROG change is ON.

● Channel pressure

Status Second
DnH vvH

n = MIDI channel number : 0H - FH (0 - 15) 0 = ch.1 15 = ch.16
vv = Value : 00H - 7FH (0 - 127)

● Pitch bend change

Status Second Third
EnH llH mmH

n = MIDI channel number : 0H - FH (0 - 15) 0 = ch.1 15 = ch.16
mm,ll = Value : 00H,00H - 7FH,7FH 0 - 16383 (-8192 - +8191)

■ System Common Message

● Tune request

Status
FBH

■ System Realtime Message

● Timing clock

Status
FBH

* Recognized after receiving FAH or FBH at MIDI (SEQ) IN, when Rx.SYNC mode is AUTO SLAVE.

● Start

Status
FAH

* Recognized when Rx.SYNC mode is AUTO SLAVE or REMOTE.

● Continue

Status
FBH

* Recognized when Rx.SYNC mode is AUTO SLAVE or REMOTE.
* Recognized only as FAH.

● Stop

Status
FCH

* Recognized when Rx.SYNC mode is AUTO SLAVE or REMOTE.

■ System Exclusive Message

Status data
F0H iiH,ddH,.....eeH
F7H

F0H : System Exclusive
ii = ID number : 00H - 7FH (0 - 127)
dd,.....ee = data : 00H - 7FH (0 - 127)
F7H : EOX (End of Exclusive/System common)

* Received when System Exclusive is up to 300 bytes.

3.2 TRANSMITTED DATA (EXPANDED SECTION)

■ Channel Voice Message

● Note off

Status Second Third
BnH kkH 40H

n = MIDI channel number : 0H - FH (0 - 15) 0 = ch.1 15 = ch.16
kk = Note number : 00H - 7FH (0 - 127)
40 = Velocity : 40H (64)

● Note on

Status Second Third
9nH kkH vvH

n = MIDI channel number : 0H - FH (0 - 15) 0 = ch.1 15 = ch.16
kk = Note number : 00H - 7FH (0 - 127)
vv = Velocity : 01H - 7FH (1 - 127)

● Polyphonic key pressure

Status Second Third
AnH kkH vvH

n = MIDI channel number : 0H - FH (0 - 15) 0 = ch.1 15 = ch.16
kk = Note number : 00H - 7FH (0 - 127)
vv = Value : 00H - 7FH (0 - 127)

* Can be SOFT THRU when received.

● Control change

Status Second Third
BnH kkH vvH

n = MIDI channel number : 0H - FH (0 - 15) 0 = ch.1 15 = ch.16
kk = Control number : 00H - 79H (0 - 121)
vv = Value : 00H - 7FH (0 - 127)

* Transmitted when Tx.CTRL change is ON.
* Can be SOFT THRU when received.

● Program change

Status Second
CnH ppH

n = MIDI channel number : 0H - FH (0 - 15) 0 = ch.1 15 = ch.16
pp = Program number : 00H - 7FH (0 - 127)

* Transmitted when Tx.PROG change is ON.
* Can be SOFT THRU when received.

● Channel pressure

Status Second
DnH vvH

n = MIDI channel number : 0H - FH (0 - 15) 0 = ch.1 15 = ch.16
vv = Value : 00H - 7FH (0 - 127)

* Can be SOFT THRU when received.

● Pitch bend change

Status Second Third
EnH llH mmH

n = MIDI channel number : 0H - FH (0 - 15) 0 = ch.1 15 = ch.16
mm,ll = Value : 00H,00H - 7FH,7FH 0 - 16383 (-8192 - +8191)

* Can be SOFT THRU when received.

■ System Common Message

● Tune request

Status
F6H

■ System Realtime Message

● Timing clock

Status
FBH

* Transmitted when Tx.CLOCK mode is ON.

● Start

Status
FAH

● Continue

Status
FBH

● Stop

Status
FCH

● Active sensing

Status
FEH

* Always transmitted up to 300msec.

■ System Exclusive Message

Status	data
F0H	iii,ddH,.....,eeH
F7H	
F0H	: System Exclusive
ii = ID number	: 00H - 7FH (0 - 127)
dd,.....,ee = data	: 00H - 7FH (0 - 127)
F7H	: EOX (End of Exclusive/System common)

* Can be SOFT THRU when System Exclusive is up to 300 bytes.

4. SOUND MODULE SECTION

When using MIDI (SEQ) IN and MIDI (SEQ) OUT.

4.1 RECOGNIZED RECEIVED DATA (SOUND MODULE SECTION)

4.1.1 Phrase part (UPPER, LOWER, BASS, DRUMS, ACCOMP1, ACCOMP2, ACCOMP3, Rx.1, Rx.2)

■ Channel Voice Message

● Note off

Status	Second	Third
8nH	kkH	vvH
9nH	kkH	00H

n = MIDI channel number : 0H - FH (0 - 15) 0 = ch.1 15 = ch.16
 kk = Note number : 00H - 7FH (0 - 127)
 vv = Velocity : 00H - 7FH (0 - 127) : ignored

* A tone whose envelope is "NO SUS" ignores Note off message.

● Note on

Status	Second	Third
8nH	kkH	vvH

n = MIDI channel number : 0H - FH (0 - 15) 0 = ch.1 15 = ch.16
 kk = Note number : 0CH - 6CH (12 - 108)
 vv = Velocity : 00H - 7FH (0 - 127)

* Notes numbers outside of the range 12 - 108 are shifted to the nearest octave inside the range.

● Control change

○ Modulation

Status	Second	Third
BnH	01H	vvH

n = MIDI channel number : 0H - FH (0 - 15) 0 = ch.1 15 = ch.16
 vv = Modulation depth : 00H - 7FH (0 - 127)

○ Data entry

Status	Second	Third
BnH	06H	vvH

n = MIDI channel number : 0H - FH (0 - 15) 0 = ch.1 15 = ch.16
 vv = Value of a parameter specified by RPN.

○ Volume

Status	Second	Third
BnH	07H	vvH

n = MIDI channel number : 0H - FH (0 - 15) 0 = ch.1 15 = ch.16
 vv = Volume : 00H - 7FH (0 - 127)

* Can be control the volume of a part accessible through the receive MIDI channel. The maximum volume is determined by MASTER VOLUME and Expression message.

○ Pan

Status	Second	Third
BnH	0AH	vvH

n = MIDI channel number : 0H - FH (0 - 15) 0 = ch.1 15 = ch.16
 vv = Pan : 00H - 7FH (0 - 127)

* Orientation of sound is as follows.
 127 = LEFT, 63 = CENTER, 0 = RIGHT

○ Expression

Status	Second	Third
BnH	0BH	vvH

n = MIDI channel number : 0H - FH (0 - 15) 0 = ch.1 15 = ch.16
 vv = Expression : 00H - 7FH (0 - 127)

* Can be control the volume of a part accesible through the receive MIDI channel.
 The maximum volume is determined by MASTER VOLUME and Volume message.

○ Hold 1

Status	Second	Third
BnH	40H	vvH

n = MIDI channel number : 0H - FH (0 - 15) 0 = ch.1 15 = ch.16
 vv = Value : 00H - 3FH = OFF, 40H - 7FH = ON

○ RPN LSB

Status	Second	Third
BnH	64H	vvH

n = MIDI channel number : 0H - FH (0 - 15) 0 = ch.1 15 = ch.16
 vv = The least significant byte of a RPN.

○ RPN MSB

Status	Second	Third
BnH	65H	vvH

n = MIDI channel number : 0H - FH (0 - 15) 0 = ch.1 15 = ch.16
 vv = The most significant byte of a RPN.

* Using RPN, RA - 50's parameter can be controlled by Control change message.
 RPN MSB and LSB specify the parameter to be controlled while Data entry sets a value of the parameter.
 Effective RPN to RA - 50 is Pitch bend sensitivity (# 0).

RPN	Data entry	Description
MSB LSB	vvH	Pitch bend sensitivity
00H 00H	vv = 0 - 24	Unit in semitone, 2 octave maximum.

● Program change

Status	Second
CnH	ppH

n = MIDI channel number : 0H - FH (0 - 15) 0 = ch.1 15 = ch.16
 pp = Program number : 00H - 7FH (0 - 127)

* Program change is used to change Patches.

● Pitch bend change

Status	Second	Third
EnH	iiH	mmH

n = MIDI channel number : 0H - FH (0 - 15) 0 = ch.1 15 = ch.16
 mm, ii = Value : 00H, 00H - 7FH, 7FH 0 - 16383 (-8192 - +8191)

■ Channel mode message

○ Reset all controllers

Status	Second	Third
BnH	79H	00H

n = MIDI channel number : 0H - FH (0 - 15) 0 = ch.1 15 = ch.16

* Set each value of the controls as follows.

Controller	Set value
Modulation	OFF (0)
Hold1	OFF (0)
Expression	Max (127)
Pitch bend change	CENTER

■ System Exclusive Message

Status	data
F0H	iiH, ddH, ..., eeH
F7H	

F0H : System Exclusive
 ii = iD number : 00H - 7FH (0 - 127)
 dd, ..., ee = data : 00H - 7FH (0 - 127)
 F7H : EOx (End of Exclusive/ System common)

* Using System Exclusive Communications, refer to Sections 5 - 8.

4.1.2 Drums part

■ Channel Voice Message

● Note off

Status	Second	Third
8nH	kkH	vvH
9nH	kkH	00H

n = MIDI channel number : 0H - FH (0 - 15) 0 = ch.1 15 = ch.16
 kk = Note number : 18H - 57H (24 - 87)
 vv = Velocity ignored

* A tone whose envelope mode is "NO SUS" ignores Note off message.

● Note on

Status	Second	Third
8nH	kkH	vvH

n = MIDI channel number : 0H - FH (0 - 15) 0 = ch.1 15 = ch.16
 kk = Note number : 18H - 57H (24 - 87)
 vv = Velocity : 01H - 7FH (1 - 127)

* Notes numbers outside of range 24 - 87 are ignored.

● Control change

○ Data entry

Status	Second	Third
BnH	06H	vvH

n = MIDI channel number : 0H - FH (0 - 15) 0 = ch.1 15 = ch.16
 vv = Value of a parameter specified by RPN.

○ Volume

Status	Second	Third
BnH	07H	vvH

n = MIDI channel number : 0H - FH (0 - 15) 0 = ch.1 15 = ch.16
 vv = Volume : 00H - 7FH (0 - 127)

* Can be control the volume of a part accesible through the receive MIDI channel.
 The maximum volume is determined by MASTER VOLUME and Expression message.

○ Expression

Status	Second	Third
BnH	08H	vvH

n = MIDI channel number : 0H - FH (0 - 15) 0 = ch.1 15 = ch.16
 vv = Expression : 00H - 7FH (0 - 127)

* Can be control the volume of a part accesible through the receive MIDI channel.
 The maximum volume is determined by MASTER VOLUME and Volume message.

○RPN LSB

Status	Second	Third
BnH	64H	vvH

n = MIDI channel number : 0H - FH (0 - 15) 0 = ch.1 15 = ch.16
 vv = The least significant byte of a RPN.

○RPN MSB

Status	Second	Third
BnH	65H	vvH

n = MIDI channel number : 0H - FH (0 - 15) 0 = ch.1 15 = ch.16
 vv = The most significant byte of a RPN.

*Using RPN, RA - 50's parameter can be controlled by Control change message.
 RPN-MSB and LSB specify the parameter to be controlled while Data entry sets a value of the parameter.
 Effective RPN to RA - 50 is Pitch bend sensitivity (# 0).

RPN	Data entry	Description
MSB LSB		
00H 00H	vvH	Pitch bend sensitivity
	vv = 0 - 24	Unit in semitone, 2 octave maximum.

●Pitch bend change

Status	Second	Third
EnH	llH	mmH

n = MIDI channel number : 0H - FH (0 - 15) 0 = ch.1 15 = ch.16
 mm,ll = Value : 00H,00H - 7FH,7FH 0 - 16383 (-8192 - +8191)

■Channel mode message

○Reset all controllers

Status	Second	Third
BnH	79H	00H

n = MIDI channel number : 0H - FH (0 - 15) 0 = ch.1 15 = ch.16

*Set each value of the controls as follows.

Controller	Set value
Pitch bend change	Center
Expression	Max (127)

■System Exclusive Message

Status	data
F0H	iiH,ddH,.....,eeH
F7H	

F0H : System Exclusive
 ii = ID number : 00H - 7FH (0 - 127)
 dd,.....,ee = data : 00H - 7FH (0 - 127)
 F7H : EOX (End of Exclusive/System common)

* Using System Exclusive Communications, refer to Sections 5 - 8.

5. Exclusive communications

Use MIDI (SEQ) IN and MIDI (SEQ) OUT, while communicating System Exclusive. Parameter for patches or other data can be transferred to RA - 50 through System Exclusive Message. Model ID# and device ID# of RA - 50 are 16H and 10H (SOUND MODULE SECTION), 2DH and 1FH (ARRANGER SECTION).

■One way communication

Byte	Description
F0H	Exclusive Status
41H	Manufacturer's ID (Roland)
1FH	Device ID
2DH	Model ID (RA - 50)
11H	Command ID (RC1)
aaH	Address MSB
bbH	Address
ccH	Address LSB
ssH	Size MSB
:	:
ssH	Size LSB
sum	Check sum
F7H	EOX (End of Exclusive/System Common)

●Data set 1 DT1 (12H)

Byte	Description
F0H	Exclusive Status
41H	Manufacturer's ID (Roland)
10H	Device ID
16H	Model ID (MT - 32)
12H	Command ID (DT1)
aaH	Address MSB
bbH	Address
ccH	Address LSB
ddH	Data
:	:
eeH	Data
sum	Check sum
F7H	EOX (End of Exclusive/System Common)

Byte	Description
F0H	Exclusive Status
41H	Manufacturer's ID (Roland)
1FH	Device ID
2DH	Model ID (RA - 50)
12H	Command ID (DT1)
aaH	Address MSB
bbH	Address
ccH	Address LSB
ddH	Data
:	:
eeH	Data
sum	Check sum
F7H	EOX (End of Exclusive/System Common)

6. PARAMETER ADDRESS MAP (Model ID = 16H)

Address are represented in 7-bit hexadecimal.

Address	IMSB	LSB
Binary	0aaa aaaa	0bbb bbbb 0ccc cccc
7-bit Hexadecimal	AA	BB CC

The actual address of a parameter is a sum of the start address of each block and one or more offset address.

Parameter base address

Temporary area (Accessed on each basic channel)

Start address	Description	
02 00 00	Timbre Temporary Area (part 1 - 8)	*6-1

Whole part (Accessible on UNIT #)

Start address	Description	
03 00 00	Patch Temporary Area (part 1)	*6-2
03 00 10	Patch Temporary Area (part 2)	
03 00 60	Patch Temporary Area (part 7)	
03 00 70	Patch Temporary Area (part 8)	
03 01 00	Patch Temporary Area (rhythm part)	
03 01 10	Rhythm Setup Temporary rea	*6-3
04 00 00	Timbre Temporary Area (part 1)	*6-1
04 01 76	Timbre Temporary Area (part 2)	
04 0B 44	Timbre Temporary Area (part 7)	
04 0D 3A	Timbre Temporary Area (part 8)	
05 00 00	Patch Memory #1	*6-4
05 00 08	Patch Memory #2	
05 07 70	Patch Memory #127	
05 07 78	Patch Memory #128	
08 00 00	Timbre Memory #1	*6-1
08 02 00	Timbre Memory #2	
08 7C 00	Timbre Memory #63	
08 7E 00	Timbre Memory #64	
10 00 00	System area	*6-5
20 00 00		
40 00 00	Write Request	*6-6
7F xx xx	All parameter reset	*6-7

Notes :

* 6 - 1 Timbre Temporary area / Timbre Memory

Offset address	Description	
00 00 00	Common parameter	*6-1-1
00 00 0E	Partial parameter (for Partial# 1)	*6-1-2
00 00 48	Partial parameter (for Partial# 2)	
00 01 02	Partial parameter (for Partial# 3)	
00 01 3C	Partial parameter (for Partial# 4)	

* 6 - 1 - 1 Common Parameter

Offset address	Description	
00	0aaa aaaa TIMBRE NAME 1	32 - 127 (ASCII)
0B	0aaa aaaa TIMBRE NAME 10	
0A	0000 aaaa Structure of Partial# 1 & 20	12 - 13 (1 - 13)
0B	0000 aaaa Structure of Partial# 3 & 40	12 - 13 (1 - 13)
0C	0000 aaaa PARTIAL MUTE0	15 (0000 - 1111)
0D	0000 000a ENV MODE	0 - 1 (Normal, No sustain)
Total size	00 00 0E	

* 6 - 1 - 2 Partial Parameter

Offset address	Description	
00 00	0aaa aaaa WG PITCH COARSE	0 - 96 (C1, C#1, - C9)
00 01	0aaa aaaa WG PITCH FINE	0 - 100 (-50 - +50)
00 02	0000 aaaa WG PITCH KEYFOLLOW	0 - 16 (-1, -1/2, -1/4, 0, 1/8, 1/4, 3/8, 1/2, 5/8, 3/4, 7/8, 1, 5/4, 3/2, 2, sl, s2)
00 03	0000 000a WG PITCH BENDER SW	0 - 1 (OFF, ON)
00 04	0000 000a WG WAVEFORM	0 - 1 (SDU, SAW)
00 05	0aaa aaaa WG PCM WAVE #	0 - 127 (1 - 128)
00 06	0aaa aaaa WG PULSE WIDTH	0 - 100
00 07	0000 aaaa WG PW VELO SENS	0 - 14 (-7 - +7)
00 08	0000 aaaa P-ENV DEPTH	0 - 10
00 09	0aaa aaaa P-ENV VELO SENS	0 - 100
00 0A	0000 0aaa P-ENV TIME KEYF	0 - 4
00 0B	0aaa aaaa P-ENV TIME 1	0 - 100
00 0C	0aaa aaaa P-ENV TIME 2	0 - 100
00 0D	0aaa aaaa P-ENV TIME 3	0 - 100
00 0E	0aaa aaaa P-ENV TIME 4	0 - 100
00 0F	0aaa aaaa P-ENV LEVEL 0	0 - 100 (-50 - +50)
00 10	0aaa aaaa P-ENV LEVEL 1	0 - 100 (-50 - +50)
00 11	0aaa aaaa P-ENV LEVEL 2	0 - 100 (-50 - +50)
00 12	0xxx xxxx P-ENV SUSTAIN LEVEL	0 - 100 (-50 - +50)
00 13	0aaa aaaa END LEVEL	0 - 100 (-50 - +50)
00 14	0aaa aaaa P-LFO RATE	0 - 100
00 15	0aaa aaaa P-LFO DEPTH	0 - 100
00 16	0aaa aaaa P-LFO MOD SENS	0 - 100
00 17	0aaa aaaa TVF CUTOFF FREQ	0 - 100
00 18	000a aaaa TVF RESONANCE	0 - 30
00 19	0000 aaaa TVF KEYFOLLOW	0 - 14 (-1, -1/2, -1/4, 0, 1/8, 1/4, 3/8, 1/2, 5/8, 3/4, 7/8, 1, 5/4, 3/2, 2)
00 1A	0aaa aaaa TVF BIAS POINT/DIR	0 - 127 (<<1A - <7C >1A - >7C)
00 1B	0000 aaaa TVF BIAS LEVEL	0 - 14 (-7 - +7)
00 1C	0aaa aaaa TVF ENV DEPTH	0 - 100
00 1D	0aaa aaaa TVF ENV VELO SENS	0 - 100

00 1E	0000 0aaa	TVF ENV DEPTH KEYF	0 - 4
00 1F	0000 0aaa	TVF ENV TIME KEYF	0 - 4
00 20	0aaa aaaa	TVF ENV TIME 1	0 - 100
00 21	0aaa aaaa	TVF ENV TIME 2	0 - 100
00 22	0aaa aaaa	TVF ENV TIME 3	0 - 100
00 23	0aaa aaaa	TVF ENV TIME 4	0 - 100
00 24	0aaa aaaa	TVF ENV TIME 5	0 - 100
00 25	0aaa aaaa	TVF ENV LEVEL 1	0 - 100
00 26	0aaa aaaa	TVF ENV LEVEL 2	0 - 100
00 27	0aaa aaaa	TVF ENV LEVEL 3	0 - 100
00 28	0aaa aaaa	TVF ENV SUSTAIN LEVEL	0 - 100

00 29	0aaa aaaa	TVA LEVEL	0 - 100
00 2A	0aaa aaaa	TVA VELO SENS	0 - 100 (-50 - +50)
00 2B	0aaa aaaa	TVA BIAS POINT 1	0 - 127 (<1A - <7C >1A - >7C)
00 2C	0000 aaaa	TVA BIAS LEVEL 1	0 - 12 (-12 - 0)
00 2D	0aaa aaaa	TVA BIAS POINT 2	0 - 127 (<1A - <7C >1A - >7C)
00 2E	0000 aaaa	TVA BIAS LEVEL 2	0 - 12 (-12 - 0)

00 2F	0000 0aaa	TVA ENV TIME KEYF	0 - 4
00 30	0000 0aaa	TVA ENV TIME V_FOLLOW	0 - 4
00 31	0aaa aaaa	TVA ENV TIME 1	0 - 100
00 32	0aaa aaaa	TVA ENV TIME 2	0 - 100
00 33	0aaa aaaa	TVA ENV TIME 3	0 - 100
00 34	0aaa aaaa	TVA ENV TIME 4	0 - 100
00 35	0aaa aaaa	TVA ENV TIME 5	0 - 100
00 36	0aaa aaaa	TVA ENV LEVEL 1	0 - 100
00 37	0aaa aaaa	TVA ENV LEVEL 2	0 - 100
00 38	0aaa aaaa	TVA ENV LEVEL 3	0 - 100
00 39	0aaa aaaa	TVA ENV SUSTAIN LEVEL	0 - 100

Total size | 00 00 3A

* 6-2 Patch temporary area

Offset address	Description
00 00	0000 0aaa TIMBRE GROUP 0 - 3 (a, b, i, r)
00 01	00aa aaaa TIMBRE NUMBER 0 - 63 (1 - 64)
00 02	00aa aaaa KEY SHIFT 0 - 48 (-24 - +24)
00 03	0aaa aaaa FINE TUNE 0 - 100 (-50 - +50)
00 04	000a aaaa BENDER RANGE 0 - 24
00 05	0000 00aa ASSIGN MODE 0 - 3 (POLY 1, POLY 2, POLY 3, POLY 4)
00 06	0000 0aaa REVERB SWITCH 0 - 1 (OFF, ON)
00 07	0xxx xxxx dummy (ignored if received)
00 08	0aaa aaaa OUTPUT LEVEL 0 - 100
00 09	0000 aaaa PANPOT 0 - 14 (R - L)
00 0A	0xxx xxxx dummy (ignored if received)
:	:
00 0F	0xxx xxxx dummy (ignored if received)
Total size	00 00 10

* 6-3 Rhythm part setup area

Offset address	Description
00 00 00	Rhythm Setup (for Key# 24) *6-3-1
00 00 04	Rhythm Setup (for Key# 25)
00 00 08	Rhythm Setup (for Key# 26)
00 00 0C	Rhythm Setup (for Key# 27)
00 00 10	Rhythm Setup (for Key# 28)
:	:
:	:
00 01 78	Rhythm Setup (for Key# 86)
00 01 7C	Rhythm Setup (for Key# 87)

* 6-3-1 Rhythm setup (for each Key #)

Offset address	Description
00 00	0aaa aaaa TIMBRE 0 - 127 (i01-i64, r01-r64)
00 01	0aaa aaaa OUTPUT LEVEL 0 - 100
00 02	0000 aaaa PANPOT 0 - 14 (R - L)
00 03	0000 000a REVERB SWITCH 0 - 1 (OFF, ON)
Total size	00 00 04

* 6-4 Patch memory

Offset address	Description
00 00	0000 00aa TIMBRE GROUP 0 - 3 (a, b, i, r)
00 01	00aa aaaa TIMBRE NUMBER 0 - 63
00 02	00aa aaaa KEY SHIFT 0 - 48 (-24 - +24)
00 03	0aaa aaaa FINE TUNE 0 - 100 (-50 - +50)
00 04	000a aaaa BENDER RANGE 0 - 24
00 05	0000 00aa ASSIGN MODE 0 - 3 (POLY 1, POLY 2, POLY 3, POLY 4)
00 06	0000 0aaa REVERB SWITCH 0 - 1 (OFF, ON)
00 07	0xxx xxxx dummy
Total size	00 00 08

* 6-5 System area

The total number of Partial reserves for 9 parts must be 32 or less. All Partial reserves must be sent as a package of 9 parts.

Offset address	Description
00 00	0aaa aaaa MASTER TUNE 0 - 127 (432.1Hz - 457.6Hz)
00 01	0000 00aa REVERB MODE 0 - 3 (Room, Hall, Plate, Tap delay)
00 02	0000 0aaa REVERB TIME 0 - 7 (1 - 8)
00 03	0000 0aaa REVERB LEVEL 0 - 7
00 04	00aa aaaa PARTIAL RESERVE (Part 1) 0 - 32
00 05	00aa aaaa PARTIAL RESERVE (Part 2) 0 - 32
00 06	00aa aaaa PARTIAL RESERVE (Part 3) 0 - 32
00 07	00aa aaaa PARTIAL RESERVE (Part 4) 0 - 32
00 08	00aa aaaa PARTIAL RESERVE (Part 5) 0 - 32
00 09	00aa aaaa PARTIAL RESERVE (Part 6) 0 - 32
00 0A	00aa aaaa PARTIAL RESERVE (Part 7) 0 - 32
00 0B	00aa aaaa PARTIAL RESERVE (Part 8) 0 - 32
00 0C	00aa aaaa PARTIAL RESERVE (Part 9) 0 - 32

00 0D	000a aaaa	MIDI CHANNEL(Part 1)	0 - 16
			(1 - 16, OFF)
00 0E	000a aaaa	MIDI CHANNEL(Part 2)	0 - 16
			(1 - 16, OFF)
00 0F	000a aaaa	MIDI CHANNEL(Part 3)	0 - 16
			(1 - 16, OFF)
00 10	000a aaaa	MIDI CHANNEL(Part 4)	0 - 16
			(1 - 16, OFF)
00 11	000a aaaa	MIDI CHANNEL(Part 5)	0 - 16
			(1 - 16, OFF)
00 12	000a aaaa	MIDI CHANNEL(Part 6)	0 - 16
			(1 - 16, OFF)
00 13	000a aaaa	MIDI CHANNEL(Part 7)	0 - 16
			(1 - 16, OFF)
00 14	000a aaaa	MIDI CHANNEL(Part 8)	0 - 16
			(1 - 16, OFF)
00 15	000a aaaa	MIDI CHANNEL(Part R)	0 - 16
			(1 - 16, OFF)
00 16	0aaa aaaa	MASTER VOLUME	0 - 100
Total size	00 00 17		

Example

Set Partial reserve of each part as follows by sending byte string listed below.

Part 1...8

Part 2...10

Part 3 - 8...0

Drums Part...8

FO 41 10 16 12 10 00 04 08 0A 00 00 00 00 00 08 66 F7

*** 6 - 6 Write Request**

Offset address	Description
00 00	00aa aaaa Timbre Write 0 - 63 (part 1) (01 - 64)
00 01	0000 0000 0 (Internal)
00 02	00aa aaaa Timbre Write (part 2)
00 03	0000 0000
:	:
00 0E	00aa aaaa Timbre Write (part 8)
00 0F	0000 0000
01 00	0aaa aaaa Patch Write 0 - 127 (part 1) (A11 - B88)
01 01	0000 0000 0 (Internal)
01 02	0aaa aaaa Patch Write (part 2)
01 03	0000 0000
:	:
01 0E	0aaa aaaa Path Write (part 8)
01 0F	0000 0000

*** 6 - 7 All Parameters Reset**

All parameters will be initialized by sending data to this address.

Address Map			
Address	Block	Sub Block	Reference
02 00 00	Timbre Temp. (Basic Ch)	Common	6-1-1
		Partial 1	6-1-2
		Partial 2	
		Partial 3	
		Partial 4	
03 00 00	Patch Temp. (Unit#)	Part 1	6-2
		Part 2	
		Part 8	
		Part R	
03 01 10	Rhythm Setup	Note# 24	6-3-1
	Temp(Unit#)	Note# 25	
		Note# 86	
		Note# 87	
04 00 00	Timbre Temp. (Unit#)	Part 1	6-1
		Part 2	
		Part 7	
		Part 8	
05 00 00	Patch Memory	# 1	6-4
		# 2	
		# 127	
		# 128	
08 00 00	Timbre Memory	# 1	6-1
		# 2	
		# 63	
		# 64	
10 00 00	System Area		6-5
20 00 00	Display		
40 00 00	Write Request		6-6
7F xx xx	All Parameters Reset		6-7

7. PARAMETER ADDRESS MAP (Model ID = 2DH)

* Device ID is only 1FH.

Parameter base address

Start address	Description	
10 00 00	MIDI Setting area	*7-1
20 00 00	String area	*7-2
60 00 00	Program Change Map area	*7-3

Notes :

* 7 - 1 MIDI Setting area

Offset address	Description	
00 00	Arranger Upper MIDI setup	*7-1-1
00 04	Arranger Lower MIDI setup	
00 08	Control Channel MIDI setup	
00 0C	Upper MIDI setup	
00 10	Lower MIDI setup	
00 14	Drums MIDI setup	
00 18	Bass MIDI setup	
00 1C	Accompaniment 1 MIDI setup	
00 20	Accompaniment 2 MIDI setup	
00 24	Accompaniment 3 MIDI setup	
00 28	Rx. 1 MIDI setup	
00 2C	Rx. 2 MIDI setup	
Total size		00 00 30

* 7 - 1 - 1 MIDI setup

Offset address	Description	
00	0000 aaaa Receive Channel	0 - 15
01	0000 aaaa Transmit Channel	0 - 15
02	0000 aaaa Expansion Channel	0 - 15
03	0000 000a OFF(0) / ON(1)	0 - 1

Example

*To get setting of each part (UPPER, LOWER, DRUMS, BASS, ACCOMP1 - 3), send a message as shown below.

FO 41 1F 2D 11 10 00 0C 00 00 1C 48 F7

* 7 - 2 String area

Offset address	Description	
00 00	0aaa aaaa character	32 - 127
:	:	(ASCII)
0n nn	0aaa aaaa character	

*This area is used for asking about style name, tone name, length of intro, card status etc. Only DT1 is effective on these address, and RQ1 is ignored. Refer to section 8.

Example

*To get a selected style name, send messages as shown below.

FO 41 1F 2D 12 20 00 00 53 54 59 4C 45 3F 10 F7 ("STYLE?")
FO 41 1F 2D 12 20 00 00 1A 46 F7 (EOF)

* 7 - 3 Program Change Map area

Offset address	Description	
00 00	Program Change Map Upper	*7-3-1
01 00	Program Change Map Lower	
02 00	Program Change Map Bass	
03 00	Program Change Map Accomp 1	
04 00	Program Change Map Accomp 2	
05 00	Program Change Map Accomp 3	
Total size		00 08 00

* 7 - 3 - 1 Program Change Map for each Part

Offset address	Description	
00	0aaa aaaa for program change 0	0 - 127
:	:	:
7F	0aaa aaaa for program change 127	0 - 127
Total size		00 01 00

Example

*To get a program change map of UPPER part, send a message as shown below.

FO 41 1F 2D 11 60 00 00 00 01 00 1F F7

Address Map

Address	Block	Reference
10 00 00	MIDI Setting	7-1
20 00 00	String	7-2, 8
60 00 00	Program Change Map	7-3

8. Communication of string packet

You will get a various information of RA-50's arranger section, using "STRING PACKET".

"STRING EXCLUSIVE" fills these conditions as shown below.

- COMMAND ID 12H (DT1)
- DEVICE ID 1FH
- ADDRESS 200000H
- DATA ASCII STRING, or 1AH (one byte)

Example 1

```
FO 41 1F 2D 12 20 00 00 53 54 59 4C 45 3F 10 F7 ( "STYLE?" )
```

Example 2

```
FO 41 1F 2D 12 20 00 00 1A 46 F7
```

"EOF" is a specific exclusive message on RA-50, this message has only one byte data (1AH) as example 2.

"MESSAGE" is a meaningful string sequence. Example 1, "MESSAGE" includes only one string. example 3, "MESSAGE" includes two strings.

Example 3

```
FO 41 0F 2D 12 20 00 00 53 54 59 4C 45 3D 3D 55 F7 ( "STYLE==" )
FO 41 0F 2D 12 20 00 00 30 3A 52 4F 43 4B 20 31 20 20 2D 20 2D 20 2D
20 20 3A 7C F7 ( "0:ROCK 1 :")
```

"STRING PACKET" is "MESSAGE" and "EOF" ("EOF comes after "MESSAGE"). Example 4 is "STRING PACKET" structured from example 1, and also Example 5 is "STRING PACKET" structured from example 3.

Example 4

```
FO 41 1F 2D 12 20 00 00 53 54 59 4C 45 3F 10 F7 ( "STYLE?" )
FO 41 1F 2D 12 20 00 00 1A 46 F7 ( EOF )
```

Example 5

```
FO 41 0F 2D 12 20 00 00 53 54 59 4C 45 3D 3D 55 F7 ( "STYLE==" )
FO 41 0F 2D 12 20 00 00 30 3A 52 4F 43 4B 20 31 20 20 2D 20 2D 20 2D 20 2D 3A 7C F7
( "0:ROCK 1 :")
FO 41 1F 2D 12 20 00 00 1A 46 F7 ( EOF )
```

Between "STRING EXCLUSIVE" of one "STRING PACKET", you can send other status. But you should not send other exclusive message. One "STRING PACKET" can include only one "MESSAGE".

Illustrating computer communication, one "STRING PACKET" means one file and one "STRING EXCLUSIVE" means one line.

"MESSAGE" has two classes as shown below.

- Ask about a value of specified parameter. (send to RA-50)
- Notify a value of specified parameter. (RA-50 returns)

Six kinds of parameter as shown below.

- STYLE TABLE
- STYLE
- CARD
- LENGTH OF INTRO
- LENGTH OF MEASURE
- TONE TABLE

When you ask about a value of specified parameter, adding "?" after parameter name.

Example 6 LENGTH OF INTRO ?

```
FO 41 0F 2D 12 20 00 00 4C 45 4E 47 54 48 20 4F 46 20 49 4E 54 52 4F 3F 7E F7
FO 41 0F 2D 12 20 00 00 1A 46 F7
```

RA-50 notifies a value after parameter name and "==".

Example 7 LENGTH OF INTRO == 96

```
FO 41 0F 2D 12 20 00 00 4C 45 4E 47 54 48 20 4F 46 20 49 4E 54 52 4F 3D 3D 39 38 54 F7
FO 41 0F 2D 12 20 00 00 1A 46 F7
```

When you design a communication program, you should observe these rules.

- When it receives "ask about a value", you should send "notify of a value".

RA-50 reacts as shown below, when RA-50 receives these "MESSAGE".

- When RA-50 receives "ask about a value", RA-50 sends "notify of a value".
- When RA-50 receives "notify of a value", RA-50 ignores it.

RA-50 doesn't send "MESSAGE" voluntarily, except "notify of a value" of CARD.

Introducing meaning of each parameter, the format of "notify of a value", and how to use it.

● STYLE TABLE

STYLE TABLE has a table of style number and style name.

Usable style numbers and style names are connected ":". When MUSIC STYLE CARD is inserted, STYLE TABLE includes style number and style name on CARD. #A style number has two characters. And the <tab> means 09H.

```
Example 8 STYLE TABLE ==
0:ROCK 1 <tab> 1:ROCK 2 <tab> 2:DISCO 1 <tab>
3:DISCO 2 <tab> 4:FUNK 1 <tab> 5:FUNK 2 <tab>
6:BALLAD <tab> 7:SLOW ROCK <tab> 8:8 BEAT 1 <tab>
9:8 BEAT 2 <tab>10:16 BEAT 1 <tab>11:16 BEAT 2 <tab>
12:REGGAE <tab>13:BOOGIE <tab>14:ROCK 'N' ROLL <tab>
15:DIXIELAND <tab>16:SWING <tab>17:BIG BAND <tab>
18:SHUFFLE <tab>19:COUNTRY <tab>20:WALTZ 1 <tab>
21:WALTZ 2 <tab>22:POLKA <tab>23:MARCH <tab>
24:BAROQUE <tab>25:BOSSANOVIA <tab>26:RHUMBA <tab>
27:CHA CHA <tab>28:SALSA <tab>29:TANGO <tab>
30:SAMBA <tab>31:FUSION <tab>
```

This "MESSAGE" is divided into some "STRING EXCLUSIVE", by reason of too long for Roland Exclusive format.

● STYLE

STYLE has a selected style number and style name.

A style number and a style name is connected ":".

Example 9 STYLE == 0 : ROCK 1 :

● CARD

When MEMORY CARD is inserted, a value of a CARD is "INSERTED". And when MEMORY CARD is not inserted, a value of a CARD is "REMOVED".

RA-50 sends voluntarily "notify of a value" of CARD without "ask about a value". When you design a communication program, you may observe these rules.

- When it receives "notify of a value", you may send "ask about a value" of STYLE TABLE or STYLE.

Example 10 CARD == INSERTED

Example 11 CARD == REMOVED

● LENGTH OF INTRO

LENGTH OF INTRO has a MIDI beat intro length of selected style. The length is notified in decimal system.

Example 12 LENGTH OF INTRO == 96

● LENGTH OF MEASURE

LENGTH OF MEASURE has a MIDI beat measure length of selected style. The length is notified in decimal system.

Example 13 LENGTH OF MEASURE == 72

● TONE TABLE

TONE TABLE has a table of tone number and tone name.
 Usable tone numbers and tone names are connected ":".
 A tone number has three characters. And the <tab> means 09H.

Example 14 TONE TABLE ==

```

0:ELEC PIANO1 <tab> 1:ELEC PIANO2 <tab> 2:ELEC PIANO3 <tab> 3:HONKYTONK <tab>
4:HARPSI 1 <tab> 5:CLAVI 1 <tab> 6:CELESTA 1 <tab> 7:HARP 1 <tab>
8:ELEC ORGAN1 <tab> 9:ELEC ORGAN2 <tab> 10:ELEC ORGAN3 <tab> 11:PIPE ORGAN1 <tab>
12:PIPE ORGAN2 <tab> 13:BREATHPIPE <tab> 14:SHAKUHACHI <tab> 15:ACCORDION <tab>
16:SYN BRASS1 <tab> 17:SYN BRASS2 <tab> 18:SYN BRASS3 <tab> 19:TRUMPET 1 <tab>
20:TROMBONE 1 <tab> 21:FRENCH HORN1 <tab> 22:BRASS SECT 1 <tab> 23:SAX 1 <tab>
24:STRING SECT1 <tab> 25:STRING SECT2 <tab> 26:PIZZICATO <tab> 27:VIOLIN 1 <tab>
28:ORCH HIT <tab> 29:CHORALE <tab> 30:SOUNDTRACK <tab> 31:WHISTLE 1 <tab>
32:FANTASY <tab> 33:ATMOSPHERE <tab> 34:WARM BELL <tab> 35:ECHO BELL <tab>
36:WATER BELL <tab> 37:ECHO PAN <tab> 38:DOCTOR SOLO <tab> 39:SQUARE WAVE <tab>
40:GUITARI <tab> 41:GUITAR2 <tab> 42:ELEC GUITARI <tab> 43:ELEC GUITAR2 <tab>
44:FLUTE 1 <tab> 45:PAN PIPES <tab> 46:CLARINET 1 <tab> 47:HARMONICA <tab>
48:ACCU BASS1 <tab> 49:ACCU BASS2 <tab> 50:ELEC BASS1 <tab> 51:SLAP BASS1 <tab>
52:SLAP BASS2 <tab> 53:FRETLESS1 <tab> 54:FRETLESS2 <tab> 55:CONTRABASS <tab>
56:VIBE1 <tab> 57:VIBE2 <tab> 58:GLOCKEN <tab> 59:XYLOPHONE <tab>
60:MARIMBA <tab> 61:JUNGLE TUNE <tab> 62:ICE RAIN <tab> 63:TELEPHONE <tab>
64:ACCU PIANO 1 <tab> 65:ACCU PIANO 2 <tab> 66:ACCU PIANO 3 <tab> 67:ELEC PIANO 4 <tab>
68:ELEC ORGAN4 <tab> 69:PIPE ORGAN3 <tab> 70:HARPSI 2 <tab> 71:HARPSI 3 <tab>
72:CLAVI 2 <tab> 73:CLAVI 3 <tab> 74:CELESTA 2 <tab> 75:SYN BRASS 4 <tab>
76:SYN BASS 1 <tab> 77:SYN BASS 2 <tab> 78:SYN BASS 3 <tab> 79:SYN BASS 4 <tab>
80:HARMO PAN <tab> 81:GLASSES <tab> 82:FUNNY VOX <tab> 83:OBOE 2001 <tab>
84:SCHOOLDAZE <tab> 85:BELLSINGER <tab> 86:STRING SECT3 <tab> 87:VIOLIN 2 <tab>
88:CELLO 1 <tab> 89:CELLO 2 <tab> 90:HARP 2 <tab> 91:SITAR <tab>
92:ELEC BASS 2 <tab> 93:FLUTE 2 <tab> 94:PICCOLO 1 <tab> 95:PICCOLO 2 <tab>
96:RECORDER <tab> 97:SAX 2 <tab> 98:SAX 3 <tab> 99:SAX 4 <tab>
100:CLARINET 2 <tab> 101:OBOE <tab> 102:ENGLISH HORN <tab> 103:BASSOON <tab>
104:TRUMPET 2 <tab> 105:TROMBONE 2 <tab> 106:FRENCH HORN2 <tab> 107:TUBA <tab>
108:BRASS SECT 2 <tab> 109:SYN MALLET <tab> 110:WINDBELL <tab> 111:TUBE BELL <tab>
112:KOTO <tab> 113:SHO <tab> 114:WHISTLE 2 <tab> 115:BOTTLEBLOW <tab>
116:TIMPANI <tab> 117:MELODIC TOM <tab> 118:DEEP SNARE <tab> 119:ELEC PERC 1 <tab>
120:ELEC PERC 2 <tab> 121:TAIKO <tab> 122:TAIKO RIM <tab> 123:CYMBAL <tab>
124:CASTANETS <tab> 125:TRIANGLE <tab> 126:BRD TWEET <tab> 127:ONE NOTE JAM <tab>
  
```

This "MESSAGE" is divided into some "STRING EXCLUSIVE", by reason of too long for Roland Exclusive format.

MIDI Implementation Chart

Function ***		Transmitted	Recognized	Remarks
Basic Channel	Default Changed	1, 1, 16 1 - 16 each	1, 1, 16, 2 - 10 1 - 16 each	Memorized except 2 - 10
Mode	Default Messages Altered	× OMNI OFF *****	Mode 3 ×	* 3
Note Number	True Voice	0 - 127 *****	0 - 127 0 - 127	
Velocity	Note ON Note OFF	○ ○8n v = 64	○ ×9n v = 0	
After Touch	Key's Ch's	○ ○	○ ○	* 2 * 2
Pitch Bender		○	○	* 2
Control Change	0 - 121	* 1	* 1	* 2
Prog Change	True #	* 1 *****	* 1 0 - 127	* 2
System Exclusive		○	○	* 2 up to 300 bytes
System Common	Song Pos Song Sel Tune	× × ○	× × ○	
System Real Time	Clock Commands	* 1 ○	* 1 * 1	
Aux Message	Local ON/OFF All Notes OFF Active Sense Reset	○ × (123) ○ ×	× × (123 - 127) × ×	* 3
Notes	* 1 Can be set to ○ or × manually. * 2 Only SOFT THRU. * 3 When power is first applied, OMNI OFF and LOCAL OFF are sent for A - UPPER and A - LOWER parts' channel			

Mode 1 : OMNI ON, POLY
Mode 3 : OMNI OFF, POLY

Mode 2 : OMNI ON, MONO
Mode 4 : OMNI OFF, MONO

○ : Yes
× : No

MIDI Implementation Chart

Function ...		Transmitted	Recognized	Remarks
Basic Channel	Default Changed	16, 2 - 10 1 - 16 each	1, 1, 16, 2 - 10 1 - 16 each	Memorized except 2 - 10
Mode	Default Messages Altered	Mode 3 x *****	Mode 3 x	
Note Number	True Voice	0 - 127 *****	0 - 127 0 - 127	
Velocity	Note ON Note OFF	○ ○ 8n v = 64	○ x 9n v = 0	
After Touch	Key's Ch's	○ ○	○ ○	* 2 * 2
Pitch Bender		○	○	* 2
Control Change	0 - 121	* 1	* 1	* 2
Prog Change	True #	* 1 *****	* 1 0 - 127	
System Exclusive		○	○	* 2 up to 300 bytes
System Common	Song Pos Song Sel Tune	x x ○	x x ○	
System Real Time	Clock Commands	* 1 ○	* 1 * 1	
Aux Message	Local ON/OFF All Notes OFF Active Sense Reset	x x (123) ○ x	x x (123 - 127) x x	
Notes		* 1 Can be set to ○ or x manually. * 2 Only SOFT THRU.		

MIDI Implementation Chart

Function ...		Transmitted	Recognized	Remarks
Basic Channel	Default Changed	16, 2 - 10 1 - 16 each	1, 1, 16, 2 - 10 1 - 16 each	Memorized except 2 - 10
Mode	Default Messages Altered	Mode 3 x *****	Mode 3 x	
Note Number	True Voice	0 - 127 *****	12 - 127 12 - 127	
Velocity	Note ON Note OFF	○ ○8n v = 64	○ x 9n v = 0	
After Touch	Key's Ch's	○ ○	○ ○	* 2 * 2
Pitch Bender		○	○	* 2
Control Change	0 - 121	* 1	* 1	* 2
Prog Change	True #	* 1 *****	* 1 0 - 127	* 2
System Exclusive		○	○	* 2 up to 300 bytes
System Common	Song Pos Song Sel Tune	x x ○	x x ○	
System Real Time	Clock Commands	* 1 ○	* 1 * 1	
Aux Message	Local ON/OFF All Notes OFF Active Sense Reset	x x (123) ○ x	x x (123 - 127) x x	* 3
Notes		* 1 Can be set to ○ or x manually. * 2 Only SOFT THRU.		

Mode 1 : OMNI ON, POLY
Mode 3 : OMNI OFF, POLY

Mode 2 : OMNI ON, MONO
Mode 4 : OMNI OFF, MONO

○ : Yes
x : No

MIDI Implementation Chart

Function ...		Transmitted	Recognized	Remarks
Basic Channel	Default	×	2 - 10	
	Changed	×	×	
Mode	Default	×	Mode 3	
	Messages	×	×	
	Altered	*****		
Note Number	True Voice	×	0 - 127	
		*****	12 - 108	
Velocity	Note ON	×	○	
	Note OFF	×	× 9n v = 0	
After Touch	Key's	×	×	
	Ch's	×	×	
Pitch Bender		×	○	
Control Change	1	×	○	Modulation
	2 - 5	×	×	
	6	×	○	Data Entry * 1
	7	×	○	Volume
	6 - 9	×	×	
	10	×	○	Pan
	11	×	○	Expression
	12 - 63	×	×	
	64	×	○	Hold 1
	65 - 99	×	×	
	100, 101	×	○	RPN LSB, MSB * 1
102 - 120	×	×		
121	×	○	Reset All Controllers	
Prog Change	True #	×	○ 0 - 127	
		*****	0 - 127	
System Exclusive		×	○	One way only
System Common	Song Pos	×	×	
	Song Sel	×	×	
	Tune	×	×	
System Real Time	Clock	×	×	
	Commands	×	×	
Aux Message	Local ON/OFF	×	×	
	All Notes OFF	×	× (123 - 127)	
	Active Sense	×	×	
	Reset	×	×	
Notes	* 1 RPN = Registered Parameter Number RPN 0 (00H, 00H) = Pitch Bend Sensitivity Data Entry sets the value of this parameter.			

SPECIFICATIONS

RA-50 <REALTIME ARRANGER>

●ARRANGER Section

MUSIC STYLE : 32 (INTERNAL)
ARRANGER CONTROL : START/STOP,
ARRANGER SELECT, INTRO/ENDING, FILL IN,
BREAK, CHORD INTELLIGENCE, MELODY
INTELLIGENCE, CHORD HOLD, SPLIT POINT,
BYPASS, VARIATION
FOOTSWITCH : MULTI FUNCTION TYPE×3

●COMPOSER Section

Number of Tracks : 2
Number of Songs to be recorded : 3

●Sound Module Section

LA System (Linear Arithmetic Synthesis)
Maximum Voices : 32
Preset Tones : 128
Preset Rhythm Tones : 30
Digital Reverberation : 8 type

●Front Panel

Number of Buttons : 74
Master Volume Knob
Tempo Knob

●Display

2 lines, 16 letter (back-lit)
LCD (Liquid Crystal Display)

●Indicators

Button Indicators : 19
BEAT Indicators : 4
MIDI Message Indicator

●Rear Panel

External Pedal Jack × 3
MIDI Connectors : 4 (KBD) IN, (KBD) OUT
(SEQ) IN, (SEQ) OUT
Output Jack : L (mono) and R
Input Jack : L (mono) and R
Headphones Jack
DC-IN Jack
Power Switch
Card Slot

●Power Supply

ACL-120 (120V)
ACI-220 (220V)
ACB-240A, ACB-240E (240V)

●Consumption

800mA/9V

●Dimensions

360(W) × 241(D) × 69(H) mm
14 1/8" × 9 3/4" × 2 3/4"

* Except for the protruding sections.

●Weight

2.0kg
4 lb 7oz

* Except for the AC Adaptor

●Accessories

Stereo Audio Cord
MIDI Cable × 2
AC Adaptor
Owner's Manual

* The supplied MIDI cable is specifically for MIDI connection. Do not use it for any other connection such as DIN Sync or audio setup.

●Options

Memory Card (M-256E)
Music Style Card (TN-SC1-XX)
Foot Switch (DP-2/6, FS-5U)

* Specifications are subject to change without notice.

INDEX

A

ACCOMP (ACCOMPANIMENT).....P15, P29, P45
ADVANCEDP22, P29, P36
ARRANGERP19, P35
ARRANGER SELECTP19, P36

B

BALANCEP19, P44
BANK.....P13
BASICP22, P29, P36
BASS.....P28, P45
BEAT INDICATORP19
BREAKP19, P39
BYPASSP19, P73, P78

C

CHORD HOLD.....P39
CHORD INTELLIGENCEP15, P40
COMPOSER.....P19, P54

D

DC INP7, P19
DRUMS (DRUM BALANCE)P45

E

EXT PEDAL.....P19

F

FILL INP19, P22, P38
FOOT SW.....P19, P66
FUNCTIONP19

G

GROUP a/bP27

I

INPUTP19
INTRO/ENDING.....P19, P32, P33, P34, P58

L

LOCAL CONTROL.....P72
LOCAL OFFP72
LOCAL ONP72
LOWERP24, P28

M

MANUAL DRUMSP19, P67
MASTER VOLUMEP8, P11, P19
MELODY INTELLIGENCEP19, P40
MEM CARDP19, P61, P84
MEMORY PROTECTP62
MIDIP72, P73, P74, P80
MIDI CHANNELP9, P21, P73
MIDI MESSAGE INDICATORP19
MIDI (KBD) INP7, P72, P74, P80
MIDI (KBD) OUT.....P72, P74, P80
MIDI (SEQ) INP72, P74, P80
MIDI (SEQ) OUTP72, P74, P80
MONITOR RECORDINGP59
MUSIC STYLEP14, P19, P22, P29
MUSIC STYLE CARD.....P31, P84

MUSIC STYLE/TONE SELECTP19

N

NUMBERP13

O

ORIGINALP29, P37
OUTPUTP7, P19

P

PART ASSIGNP46
PEDAL SWITCHP19, P66
PHONES (HEADPHONES) SOCKETP19
PLAY.....P57, P58
POWERP7, P8, P19
PROGRAM CHANGEP74
PROGRAM CHANGE MAPP78

R

RECORD (RECORDING)P54, P55, P59, P60
REVERBP19, P46
ROM PLAYP10, P11, P19
ROOT NOTEP35

S

SONG NUMBER.....P54
SOUND POSITIONS (PANNING)P68
SPLITP24
SPLIT POINTP12, P19, P24
STYLE PERFORMANCE.....P29
SYNC MODEP77
SYNC STARTP15, P19, P32, P33, P58, P60

T

TEMPO KNOBP19, P34
TO ORIGINAL.....P38
TO VARIATION.....P38
TRACKP55
TUNE/BEND.....P65, P66, P69
TYPEP48

U

UPPERP24, P27
USER PROGRAMP49

V

VARIATIONP19, P29, P37

W

WRITE.....P52, P63, P64

RA-50

Sound List

(same as E-20)

B group

Tone No.	Tone Name
----------	-----------

B11	ACOU PIANO 1	B31	HARMO PAN	B51	RECORDER	B71	KOTO
B12	ACOU PIANO 2	B32	GLASSES	B52	SAX 2	B72	SHO
B13	ACOU PIANO 3	B33	FUNNY VOX	B53	SAX 3	B73	WHISTLE 2
B14	ELEC PIANO 4	B34	OBOE 2001	B54	SAX 4	B74	BOTTLEBLOW
B15	ELEC ORGAN 4	B35	SCHOOLDAZE	B55	CLARINET 2	B75	TIMPANI
B16	PIPE ORGAN 3	B36	BELLSINGER	B56	OBOE	B76	MELODIC TOM
B17	HARPSI 2	B37	STRING SECT 3	B57	ENGLISH HORN	B77	DEEP SNARE
B18	HARPSI 3	B38	VIOLIN 2	B58	BASSOON	B78	ELEC PERC 1
B21	CLAVI 2	B41	CELLO 1	B61	TRUMPET 2	B81	ELEC PERC 2
B22	CLAVI 3	B42	CELLO 2	B62	TROMBONE 2	B82	TAIKO
B23	CELESTA 2	B43	HARP 2	B63	FRENCH HORN 2	B83	TAIKO RIM
B24	SYN BRASS 4	B44	SITAR	B64	TUBA	B84	CYMBAL
B25	SYN BASS 1	B45	ELEC BASS 2	B65	BRASS SECT 2	B85	CASTANETS
B26	SYN BASS 2	B46	FLUTE 2	B66	SYN MALLET	B86	TRIANGLE
B27	SYN BASS 3	B47	PICCOLO 1	B67	WINDBELL	B87	BIRD TWEET
B28	SYN BASS 4	B48	PICCOLO 2	B68	TUBE BELL	B88	ONE NOTE JAM



RA-50

Sound List

(same as MT-32)

A group

Tone No.	Tone Name
----------	-----------

A11	ACOU PIANO 1	A31	HARPSI 1	A51	FANTASY	A71	STRING SECT 1
A12	ACOU PIANO 2	A32	HARPSI 2	A52	HARMO PAN	A72	STRING SECT 2
A13	ACOU PIANO 3	A33	HARPSI 3	A53	CHORAL	A73	STRING SECT 3
A14	ELEC PIANO 1	A34	CLAVI 1	A54	GLASSES	A74	PIZZICATO
A15	ELEC PIANO 2	A35	CLAVI 2	A55	SOUNDTRACK	A75	VIOLIN 1
A16	ELEC PIANO 3	A36	CLAVI 3	A56	ATMOSPHERE	A76	VIOLIN 2
A17	ELEC PIANO 4	A37	CELESTA 1	A57	WARM BELL	A77	CELLO 1
A18	HONKYTONK	A38	CELESTA 2	A58	FUNNY VOX	A78	CELLO 2
A21	ELEC ORGAN 1	A41	SYN BRASS 1	A61	ECHO BELL	A81	CONTRABASS
A22	ELEC ORGAN 2	A42	SYN BRASS 2	A62	ICE RAIN	A82	HARP 1
A23	ELEC ORGAN 3	A43	SYN BRASS 3	A63	OBOE 2001	A83	HARP 2
A24	ELEC ORGAN 4	A44	SYN BRASS 4	A64	ECHO PAN	A84	GUITAR 1
A25	PIPE ORGAN 1	A45	SYN BASS 1	A65	DOCTOR SOLO	A85	GUITAR 2
A26	PIPE ORGAN 2	A46	SYN BASS 2	A66	SCHOOLDAZE	A86	ELEC GUITAR 1
A27	PIPE ORGAN 3	A47	SYN BASS 3	A67	BELLSINGER	A87	ELEC GUITAR 2
A28	ACCORDION	A48	SYN BASS 4	A68	SQUARE WAVE	A88	SITAR



RA-50

Sound List

(same as E-20)

A group

Tone No.	Tone Name
----------	-----------

A11	ELEC PIANO 1	A31	SYN BRASS 1	A51	FANTASY	A71	ACOU BASS 1
A12	ELEC PIANO 2	A32	SYN BRASS 2	A52	ATMOSPHERE	A72	ACOU BASS 2
A13	ELEC PIANO 3	A33	SYN BRASS 2	A53	WARM BELL	A73	ELEC BASS 1
A14	HONKYTONK	A34	TRUMPET 1	A54	ECHO BELL	A74	SLAP BASS 1
A15	HARPSI 1	A35	TROMBONE 1	A55	WATER BELL	A75	SLAP BASS 2
A16	CLAVI 1	A36	FRENCH HORN 1	A56	ECHO PAN	A76	FRETLESS 1
A17	CELESTA 1	A37	BRASS SECT 1	A57	DOCTOR SOLO	A77	FRETLESS 2
A18	HARP 1	A38	SAX 1	A58	SQUARE WAVE	A78	CONTRABASS
A21	ELEC ORGAN 1	A41	STRING SECT 1	A61	GUITAR 1	A81	VIBE 1
A22	ELEC ORGAN 2	A42	STRING SECT 2	A62	GUITAR 2	A82	VIBE 2
A23	ELEC ORGAN 3	A43	PIZZICATO	A63	ELEC GUITAR 1	A83	GLOCKEN
A24	PIPE ORGAN 1	A44	VIOLIN 1	A64	ELEC GUITAR 2	A84	XYLOPHONE
A25	PIPE ORGAN 2	A45	ORCH HIT	A65	FLUTE 1	A85	MARIMBA
A26	BREATHPIPE	A46	CHORALE	A66	PAN PIPES	A86	JUNGLE TUNE
A27	SHAKUHACHI	A47	SOUNDTRACK	A67	CLARINET 1	A87	ICE RAIN
A28	ACCORDION	A48	WHISTLE 1	A68	HARMONICA	A88	TELEPHONE

RA-50

Sound List

(same as MT-32)

B group

Tone No.	Tone Name
----------	-----------

B11	ACOU BASS 1	B31	SAX 3	B51	BRASS SECT 2	B71	TIMPANI
B12	ACOU BASS 2	B32	SAX 4	B52	VIBE 1	B72	MELODIC TOM
B13	ELEC BASS 1	B33	CLARINET 1	B53	VIBE 2	B73	DEEP SNARE
B14	ELEC BASS 2	B34	CLARINET 2	B54	SYN Mallet	B74	ELEC PERC 1
B15	SLAP BASS 1	B35	OBOE	B55	WIND BELL	B75	ELEC PERC 2
B16	SLAP BASS 2	B36	ENGLISH HORN	B56	GLOCKEN	B76	TAIKO
B17	FRETLESS 1	B37	BASSOON	B57	TUBE BELL	B77	TAIKO RIM
B18	FRETLESS 2	B38	HARMONICA	B58	XYLOPHONE	B78	CYMBAL
B21	FLUTE 1	B41	TRUMPET 1	B61	MARIMBA	B81	CASTANETS
B22	FLUTE 2	B42	TRUMPET 2	B62	KOTO	B82	TRIANGLE
B23	PICCOLO 1	B43	TROMBONE 1	B63	SHO	B83	ORCH HIT
B24	PICCOLO 2	B44	TROMBONE 2	B64	SHAKUHACHI	B84	TELEPHONE
B25	RECORDER	B45	FRENCH HORN 1	B65	WHISTLE 1	B85	BIRD TWEET
B26	PAN PIPES	B46	FRENCH HORN 2	B66	WHISTLE 2	B86	ONE NOTE JAM
B27	SAX 1	B47	TUBA	B67	BOTTLE BLOW	B87	WATER BELL
B28	SAX 2	B48	BRASS SECT 1	B68	BREATHPIPE	B88	JUNGLE TUNE

Information

- Please use this AC adaptor only with the specified device.
- Please use the AC Adaptor of an appropriate voltage (120, 220 or 240) depending on the voltage system in your country.
- When the device is not used for a long period, be sure to disconnect the AC adaptor (Power Supply Unit) from the wall outlet.
- When you need repair service, call your local Roland Service Station as shown below or the authorized Roland distributor in your country.

U. S. A.

Roland Corp US
7200 Dominion Circle
Los Angeles, CA. 90040-3647
U. S. A.
☎ (213) 685-5141

CANADA

Roland Canada Music Ltd.
(Head Office)
13880 Mayfield Place
Richmond B. C., V6V 2E4
CANADA
☎ (604) 270-6626

Roland Canada Music Ltd.
3469 rue Ashby,
St Laurent,
Quebec H4R 2C1
CANADA
☎ (514) 335-2009

Roland Canada Music Ltd.
Unit B-12, 1515 Matheson Blvd
Mississauga, Ontario L4W 2P5
CANADA
☎ (416) 825-4880

AUSTRALIA

Roland Corporation
(Australia) Pty. Ltd.
(Head Office)
38 Campbell Avenue
Dee Why West, NSW 2099
AUSTRALIA
☎ (02) 982-8266

Roland Corporation
(Australia) Pty. Ltd.
(Melbourne Office)
50 Garden Street
South Yarra, Victoria 3141
AUSTRALIA
☎ (03) 241-1254

NEW ZEALAND

Roland Corporation (NZ) Ltd.
97 Mt. Eden Road, Mt. Eden,
Auckland 3
NEW ZEALAND
☎ (09) 398-715

UNITED KINGDOM

Roland (UK) Ltd.
Amalgamated Drive
West Cross Centre, Brentford,
Middlesex TW8 9EZ,
UNITED KINGDOM
☎ (01) 568-4578

WEST GERMANY

Roland Elektronische
Musikinstrumente
Handelsgesellschaft mbH.
Oststrasse 96,
2000 Norderstedt
WEST GERMANY
☎ 040/52 60 09 25

BELGIUM/HOLLAND/ LUXEMBOURG

Roland Benelux N. V.
Houtstraat 1
B-2431 Oevel-Westerlo
BELGIUM
☎ 014-58 45 39

DENMARK

Roland Scandinavia A/S
Langebrogade 6, 1937,
DK-1023 Copenhagen K.
DENMARK
☎ (01) 95 31 11

SWEDEN

Roland Scandinavia A/S
Swedish Sales Office
DanvikCenter 28A, 2tr.
S-131 30 Nacka,
SWEDEN
☎ 08-702 00 20

NORWAY

Benum Music A/S
Haakon den godes Vei 14
N-0319 Oslo 3,
NORWAY
(Box 145 Vindern, N-0319
Oslo 3 NORWAY)
☎ 02 141266

FINLAND

OY Musiikki Fazer Musik AB
Takomotie 3
00380 Heisinki 38,
FINLAND
☎ 05 56551

ITALY

Roland Italy S. P. A.
Via Gallarate 58
20151 Milano
ITALY
☎ 02-3086849

SWITZERLAND

Musitronic AG
Gerberstrasse 5, CH-4410
Liestal
SWITZERLAND
☎ 061/921 16 15

FRANCE

Musikengro
102, Avenue Jean-Jaures
69387 Lyon Cedex 07
FRANCE
☎ (7) 858-54 60

Musikengro
(Paris Office)
Centre Region Parisienne
41 rue Charles-Fourier,
94400 Vitry s/Seine
FRANCE
☎ (1) 4680 86 62

SPAIN

Vietronic S. A.
Bolivia 239
08020 Barcelona
SPAIN
☎ 34-307 47 12

AUSTRIA

E. Dematte & Co.
Nue-Rum Siemens-Strasse 4
A-6021 Innsbruck box 591
AUSTRIA
☎ 43 (05222) 63 4510

GREECE

A. ANDREADES & Co. Ltd.
Fidiou Str., 106 78
Athens
GREECE
☎ 3620130

For the U.K.

IMPORTANT: THE WIRES IN THIS MAINS LEAD ARE COLOURED IN ACCORDANCE WITH THE FOLLOWING CODE.

BLUE : NEUTRAL
BROWN : LIVE

As the colours of the wires in the mains lead of this apparatus may not correspond with the coloured markings identifying the terminals in your plug proceed as follows:

The wire which is coloured BLUE must be connected to the terminal which is marked with the letter N or coloured BLACK.

The wire which is coloured BROWN must be connected to the terminal which is marked with the letter L or coloured RED.

